

2020 Physical Fitness Report of Macao SAR Residents



2020
Physical Fitness
Report of Macao SAR
Residents

Title : 2020 Physical Fitness Report of Macao SAR Residents

Published by : Sports Bureau, Macao SAR

Website : [http : //www.sport.gov.mo](http://www.sport.gov.mo)

E-mail : info@sport.gov.mo

Cover designed by : Netvision Media LTD.

Size : 21 cm x 29.7 cm H

Impressão : Netvision Media LTD.

Published in August, 2023

Edition : 1st Edition (Not For Sale)

ISBN 978-99981-897-3-7 (E-book)

Research institutes of “2020 Physical Fitness Study of Macao SAR Residents”:

Organizing institution : Sports Bureau, Macao SAR

Technical support : China Institute of Sport Science, General
Administration of Sport of China

Coordinating institutions : Education and Youth Development Bureau
Health Bureau
Social Welfare Bureau
Macao Polytechnic University

Technical Support Group of “2020 Physical Fitness Study of Macao SAR Residents”:

Team Leader : Zhang Yanfeng, Wang Mei

Member : Wang Huan, Fan Chaoqun, Wu Dongming, Feng Qiang,
Wang Jingjing, Liu Xinhua, Li Sen, Tu Chunjing, Pan Xiang,
Gao Yibo, Jiang Lupei, Fu Bing, Zhao Shuangying, Wu Qinghua,
Zhang Lixin, Hu Weitong

Preface

Ho Iat Seng, Chief Executive of the Macao SAR Government

The *2020 Physical Fitness Report of Macao SAR Residents* is a major accomplishment of the Macao SAR Government's constant review and evaluation of Macao residents' basic physical health. It provides essential reference of the health status of Macao residents and a scientific basis for the SAR Government to develop various policies related to physical fitness.

The physical and psychological health of the general public is the mainstay of the society's sustainable economic development. Setting great store by the tasks related to residents' health, the current government has been building and enhancing public sports facilities and fitness venues, as well as actively supporting various activities of sports for all. This is to encourage residents to develop healthy lifestyles and to create a favorable social atmosphere of national fitness.

The COVID-19 pandemic, while posing great challenge to our physical and psychological health, also prompts us to enhance our awareness of maintaining healthy lifestyles, and to improve our physical fitness and immunity through scientific and appropriate physical exercise. Currently, the Macao SAR Government is preparing for the 15th National Games of China. I hope that Macao residents would take this opportunity to actively engage in national fitness and lead healthy lifestyles in order to keep improving our physical fitness level!

October 2022

Preface

Ao Ieong U, Secretary for Social Affairs and Culture, Macao SAR Government

The Macao SAR Government has been encouraging residents to develop the habit of exercising to create an atmosphere of national fitness. Regular physical fitness study is conducted to assist relevant departments in keeping abreast of the physical fitness conditions of Macao residents, and the data collected provide a significant scientific basis for policy-making related to improving the physical fitness level of residents.

With an aim to ensure and promote healthy physical and psychological development of residents, the Macao SAR Government has been conducting the physical fitness study of Macao residents every five years in accordance with China's standardized monitoring system since 2005. In 2020, the fourth physical fitness study of Macao residents was completed successfully through inter-departmental cooperation. The publication of *The 2020 Physical Fitness Report of Macao SAR Residents* further enriches the physical fitness database of Macao residents and provides references for the decision-making on the development of sports, health, education and other aspects.

As indicated in this report, Macao residents' overall physical fitness in 2020 has slightly improved than that in 2015, but there is still much room for improvement in making exercising a habit. I hope this report will raise residents' attention to their physical fitness and integrate exercise into their daily lives. The Macao SAR Government will continue to enrich sports for all activities and strengthen health education and promotion to encourage residents to develop healthy lifestyles and a habit of exercising. I hope all social sectors would work together to enhance the physical fitness of Macao residents and contribute to a healthy city.

October 2022

Preface

Cao Jingwei, Director of China Institute of Sport Science, General Administration of Sport of China

Macao has been improving the overall level of sports causes since the new century. The Macao SAR Government pays close attention to the physical fitness study, as it is a crucial approach to learn the fitness status of Macao residents. Since 2001, the research of physical fitness study in Macao region has been initiated in collaboration with mainland China. The first, second and third physical fitness studies of Macao residents were conducted on residents of all ages in 2005, 2010 and 2015 respectively. These results laid a significant scientific foundation for the Macao SAR Government in related policy-making and the promotion of sports and fitness activities to Macao residents. Today, the *2020 Physical Fitness Report of Macao SAR Residents*, which contains the results of the fourth physical fitness study, is officially published. I hereby sincerely extend my heartfelt congratulations.

In this physical fitness study of Macao residents, China Institute of Sport Science and the Sports Bureau of Macao SAR Government teamed up to make fruitful achievements in monitoring technology and organization. This has further enhanced the message of health and fitness through exercising as well as the technology development of the study. I look forward to further enhancing the cooperation between the two parties in the future, and to actively engage in the overall development of national fitness and health. With the strong support from mainland China and the increased competitiveness of Macao, I wish efforts would be made to further strengthen the sports cooperation in the Guangdong-Hong Kong-Macao Greater Bay Area and to expand sports development of Macao SAR in an effort to build Macao into a greater society and continue to elaborate more wonderful and glamorous “Macao stories”.

October 2022

Prologue

Pun Weng Kun, President of Sports Bureau of Macao SAR Government

Everyone desires to be healthy, and the government also pays great attention to the physical fitness of residents. Since 2005, the Macao SAR Government has been conducting the quinquennial physical fitness study of Macao residents to keep abreast of their physical conditions and changing patterns, from which formulates corresponding policies to promote the development of sports for all, and elevates the physical fitness level of residents as the ultimate goal.

Following the three physical fitness studies of Macao residents conducted in 2005, 2010 and 2015, the fourth physical fitness study of Macao residents was conducted in 2020 with continual technical support from the China Institute of Sport Science. In order to fully reflect the periodicity and the organizational standardization of the study, and to facilitate the study's longitudinal comparability, the age range of subjects is expanded from 3~69 to 3~79 due to aging population. Other aspects comprising sampling methods such as sampling sites, grouping, sample size of each group and testing methods are basically the same as those in 2015. In terms of physical fitness indicators, body fat percentage, submaximal bicycle ergometer exercise test, 2-minute high-knee running in place and 30-second chair stand are added to ensure continuity and comparability of the indicators.

The data of the fourth physical fitness study of Macao residents in 2020 was successfully collected. Four main age groups were categorized including young children (aged 3~6), children and adolescents (students) (aged 6~22), adults (aged 20~59) and seniors (aged 60~79). A total of 11,414 valid samples were collected. Now the *2020 Physical Fitness Report of Macao SAR Residents* has been composed through which all details of the study will be published to all sectors of the society.

I hereby would like to express my sincere gratitude to the China Institute of Sport Science of the General Administration of Sport of China for its assistance and guidance. With this opportunity, I would also like to express my gratitude to the coordinating institutions of physical fitness study of Macao residents - the Education and Youth Development Bureau, the Health Bureau, the Social Welfare Bureau, the Macao Polytechnic University, as well as the individuals, relevant organizations and staff members who engaged in the physical fitness study. We strive to edit and proofread this report in a thorough manner, nonetheless, omissions are inevitable. In case of any omission, we would like to invite all social sectors to give us advice and make the utmost efforts to work together to improve our residents' physical fitness level.

October 2022

Contents

Part I Physical Fitness Study and Implementation	1
I. Introduction	2
II. Subjects and Methods	2
(I) Subjects	2
(II) Sampling Principles and Methods	3
1. Principles	3
2. Methods	3
3. Grouping and Sample Size	4
4. Calculation of Age	4
5. Principles of Sample Selection	5
(III) Examined Variables	5
1. Indicators of Inquiry	5
2. Study Indicators	24
(IV) Testing Apparatus	25
(V) Testing Methods	25
(VI) Scheduling	25
III. Organization and Implementation	26
(I) Work Preparation	26
1. Establishment of Organizational Network and Leadership	26
2. Revision of 2020 Physical Fitness Study Scheme of Macao Residents	27
3. Establishment of Study Teams	28
4. Preparation of Testing Apparatus	29
(II) Technical Training	29
(III) Data Acquisition	29
(IV) Data Summarization	29
IV. Quality Control	30
(I) Quality Control of Pre-study Preparation	30
1. Establishment of Organizational Network and Leadership	30
2. Revision of 2020 Physical Fitness Study Scheme	30
3. Establishment of Study Teams	30
4. Preparation of Testing Apparatus	30
5. Technical Training	30
(II) Quality Control of Data Acquisition	31
1. Preparation before Data Acquisition	31
2. Quality Control during Data Acquisition	33
(III) Quality Control of Data Summarization	42
1. Checking of Data Registration Manual	42
2. Examination of Data Registration Manual	44
3. Data Entry	44

4. Checking of Entry Results	44
5. Data Cleaning	45
6. Database Establishment	46
V. Statistical Analysis	47
(I) Grouping	47
(II) Indicators	47
1. Indicators of Inquiry	47
2. Study Indicators	47
3. Derivative Indicators	48
4. Health Indicators	48
(III) Contents of Calculation	49
(IV) Elaboration on Calculation Methods	50
1. Mean	50
2. Standard Deviation	50
3. Percentile	50
4. t-Test (Test of difference t in mean values of two samples)	50
5. Proportion	51
6. Significance Test for Proportion	51
(V) Statistical Tool	52
<hr/>	
Part II Study Results	53
I. Young Children	54
(I) Physical Fitness Conditions of Young Children in 2020	54
1. Basic Information of the Subjects	54
2. Lifestyle	54
2.1 Birth and Feeding Patterns	54
2.2 Living Habits	56
2.3 Physical Exercise	57
2.4 Occurrence of Diseases	59
2.5 Dental Hygiene	59
2.6 Fitness Literacy	60
2.6.1 Personal Traits and Home Environment	60
2.6.2 Community Environment	62
3. Anthropometric Measurements	62
3.1 Length Indicators	62
3.2 Weight and BMI	64
3.3 Circumference Indicators	65
3.4 Width Indicators	67
3.5 Body Fat Percentage	68
4. Physiological Function	68
5. Physical Fitness	69
5.1 Speed and Agility	69

5.2 Strength	70
5.3 Flexibility	71
5.4 Balance	71
6. Teeth	72
6.1 Occurrence of Decayed Primary Teeth	72
6.2 Occurrence of Decayed Permanent Teeth	74
(II) Comparison of 2020 and 2015 Results on the Physical Fitness Study of Macao Young Children	74
1. Overall Comparison of Young Children by Age	74
1.1 Comparison of Basic Information	74
1.2 Comparison of Study Indicators	76
2. Comparison of Young Children by Age	77
2.1 Comparison of Anthropometric Measurements	77
2.1.1 Length Indicators	77
2.1.2 Weight and BMI	78
2.1.3 Circumference Indicators	80
2.1.4 Width Indicators	81
2.2 Comparison of Physiological Function	81
2.3 Comparison of Physical Fitness	82
2.3.1 Speed and Agility	82
2.3.2 Strength	82
2.3.3 Flexibility	83
2.3.4 Balance	83
2.4 Comparison of Teeth	84
2.4.1 Occurrence of Decayed Primary Teeth	84
2.4.2 Occurrence of Decayed Permanent Teeth	85
(III) Summary	87
1. Summary of 2020 Results on Physical Fitness Study of Young Children	87
1.1 Feeding Patterns and Living Habits	87
1.2 Physical Exercise	87
1.3 Anthropometric Measurements	87
1.4 Physiological Function and Physical Fitness	87
1.5 Teeth	88
2. Comparison of 2020 and 2015 Physical Fitness Study Results of Young Children	88
II. Children and Adolescents (Students)	89
(I) Physical Fitness Conditions of Children and Adolescents (Students) in 2020	89
1. Basic Information of the Subjects	89
2. Lifestyle	89
2.1 Living Habits	90
2.1.1 Analysis of Electronic Device Use	90
2.1.2 Analysis of Sleep Time	92
2.1.3 Transportation Means	94
2.2 Physical Education at School	95
2.3 Extracurricular Physical Exercises	96
2.3.1 Frequency of Physical Exercise	96

2.3.2 Average Duration of Each Exercise	98
2.3.3 Intensity of Each Exercise	99
2.3.4 Analysis of Frequent Exercisers	100
2.4 Major Physical Exercises	100
2.5 Strength exercise	100
2.6 Occurrence of Diseases	101
2.6.1 Analysis of Prevalence of Diseases	101
2.6.2 Prevalence of Diseases	102
2.7 Dental Hygiene	102
2.8 Fitness Literacy	104
2.8.1 Cognition	105
2.8.2 Attitude	106
2.8.3 Ability and Skill	106
2.8.4 Behavior and Habit	108
3. Anthropometric Measurements	108
3.1 Length Indicators	108
3.2 Weight, BMI and Body Fat Percentage	110
3.3 Circumference Indicators	112
3.4 Width Indicators	114
4. Physiological Function	115
4.1 Resting Pulse	115
4.2 Blood Pressure	115
4.3 Vital Capacity	117
5. Physical Fitness	118
5.1 Speed	118
5.2 Strength	119
5.3 Endurance Run	122
5.4 Flexibility	123
5.5 Reaction	123
5.6 Balance	124
6. Teeth	124
6.1 Occurrence of Decayed Primary Teeth	124
6.2 Occurrence of Decayed Permanent Teeth	127
7. Vision	129
7.1 Poor Vision	129
7.2 Color Vision	130
(II) Comparison of 2020 and 2015 Results on the Physical Fitness Study of Macao Children and Adolescents (Students)	131
1. Overall Comparison of Children and Adolescents (Students) by Age	131
1.1 Comparison of Basic Information	131
1.2 Comparison of Lifestyle	132
1.2.1 Living Habits	132
1.2.2 Physical Education at School	133
1.2.3 Extracurricular Physical Exercises	134

1.2.4 Occurrence of Diseases	134
1.2.5 Dental Hygiene	134
1.3 Comparison of Study Indicators	135
2. Comparison of Children and Adolescents (Students) by Age	136
2.1 Comparison of Anthropometric Measurements	136
2.1.1 Length Indicators	136
2.1.2 Weight and BMI	138
2.1.3 Circumference Indicators	140
2.1.4 Width Indicators	143
2.2 Comparison of Physiological Function	144
2.2.1 Resting Pulse	144
2.2.2 Blood Pressure	145
2.2.3 Vital Capacity	147
2.3 Comparison of Physical Fitness	149
2.3.1 Speed	149
2.3.2 Strength	149
2.3.3 Endurance Run	153
2.3.4 Flexibility	154
2.3.5 Reaction	154
2.3.6 Balance	155
2.4 Comparison of Teeth Status	156
2.4.1 Occurrence of Decayed Primary Teeth	156
2.4.2 Occurrence of Decayed Permanent Teeth	158
2.5 Comparison of Vision	160
2.6 Comparison of Color Vision	161
(III) Summary	162
1. Summary of 2020 Results on Physical Fitness Study of Children and Adolescents (Students)	162
1.1 Living Habits and Physical Exercises	162
1.2 Anthropometric Measurements	163
1.3 Physiological Function	163
1.4 Physical Fitness	163
1.5 Teeth	163
1.6 Vision	163
2. Comparison of 2020 and 2015 Physical Fitness Study Results of Children and Adolescents (Students)	163
III. Adults	166
(I) Physical Fitness Conditions of Adults in 2020	166
1. Basic Information of the Subjects	166
2. Lifestyle	167
2.1 Living Habits	167
2.2 Physical Exercise	168
2.3 Occurrence of Diseases	172
2.4 Perception of the Physical Fitness Study	172
2.5 Fitness Literacy	173

2.5.1 Cognition	173
2.5.2 Attitude	173
2.5.3 Ability and Skill	174
2.5.4 Behavior and Habit	174
3. Anthropometric Measurements	175
3.1 Length Indicators	175
3.2 Weight and BMI	176
3.3 Circumference Indicators	178
3.4 Width Indicators	180
3.5 Body Composition	181
4. Physiological Function	182
4.1 Resting Pulse	182
4.2 Blood Pressure	183
4.3 Vital Capacity	184
4.4 Step Test Index	185
4.5 Submaximal Bicycle Ergometer Exercise Test	186
5. Physical Fitness	186
5.1 Strength	186
5.2 Flexibility	189
5.3 Reaction	189
5.4 Balance	190
(II) Comparison of 2020 and 2015 Results on the Physical Fitness Study of Macao Adults	190
1. Overall Comparison of Adults by Age	190
1.1 Comparison of Basic Information	190
1.2 Comparison of Lifestyle	191
1.2.1 Living Habits	191
1.2.2 Physical Exercise	192
1.2.3 Occurrence of Diseases and Perception of the Physical Fitness Study	193
1.3 Comparison of Study Indicators	194
2. Comparison of Adults by Age	197
2.1 Comparison of Anthropometric Measurements	197
2.1.1 Length Indicators	197
2.1.2 Weight and BMI	198
2.1.3 Circumference Indicators	200
2.1.4 Width Indicators	202
2.1.5 Body Composition	203
2.2 Comparison of Physiological Function	204
2.2.1 Resting Pulse	204
2.2.2 Blood Pressure	204
2.2.3 Vital Capacity and Vital Capacity/Weight	206
2.2.4 Step Test Index	207
2.3 Comparison of Physical Fitness	207
2.3.1 Strength	207
2.3.2 Flexibility	208

2.3.3 Reaction	209
2.3.4 Balance	209
(III) Summary	210
1. Summary of 2020 Results on Physical Fitness Study of Adults	210
1.1 Living Habits and Physical Exercise	210
1.2 Anthropometric Measurements	211
1.3 Physiological Function	211
1.4 Physical Fitness	211
2. Comparison of 2020 and 2015 Physical Fitness Study Results of Adults	211
IV. Seniors	213
(I) Physical Fitness Conditions of Seniors in 2020	213
1. Basic Information of the Subjects	213
2. Lifestyle	214
2.1 Living Habits	214
2.2 Physical Exercise	216
2.3 Occurrence of Diseases	219
2.4 Perception of the Physical Fitness Study	219
2.5 Fitness Literacy	219
2.5.1 Cognition	219
2.5.2 Attitude	220
2.5.3 Ability and Skill	220
2.5.4 Behavior and Habit	221
3. Anthropometric Measurements	221
3.1 Length Indicators	221
3.2 Weight and BMI	223
3.3 Circumference Indicators	224
3.4 Width Indicators	226
3.5 Body Composition	227
4. Physiological Function	228
4.1 Resting Pulse	228
4.2 Blood Pressure	228
4.3 Vital Capacity	230
4.4 Two-minute High-knee Running in Place	231
5. Physical Fitness	231
5.1 Strength	231
5.2 Flexibility	232
5.3 Reaction	233
5.4 Balance	233
(II) Comparison of 2020 and 2015 Results on the Physical Fitness Study of Macao Seniors	234
1. Overall Comparison of Seniors by Age	234
1.1 Comparison of Basic Information	234
1.2 Comparison of Lifestyle	235
1.2.1 Living Habits	235
1.2.2 Physical Exercise	235

1.2.3 Occurrence of Diseases and Perception of the Physical Fitness Study	237
1.3 Comparison of Study Indicators	238
2. Comparison of Seniors by Age	240
2.1 Comparison of Anthropometric Measurements	240
2.1.1 Length Indicators	240
2.1.2 Weight and BMI	241
2.1.3 Circumference Indicators	242
2.1.4 Width Indicators	243
2.1.5 Body Composition	243
2.2 Comparison of Physiological Function	244
2.2.1 Resting Pulse	244
2.2.2 Blood Pressure	244
2.2.3 Vital Capacity	245
2.3 Comparison of Physical Fitness	246
2.3.1 Strength	246
2.3.2 Flexibility	246
2.3.3 Reaction	246
2.3.4 Balance	247
(III) Summary	247
1. Summary of 2020 Results on Physical Fitness Study of Seniors	247
2. Comparison of 2020 and 2015 Physical Fitness Study Results of Seniors	247
V. Summary of Comparison of 2020 and 2015 Results on the Physical Fitness Study	248
<hr/>	
Part III Statistics	249
I. Young Children	250
1. Basic Information of the Subjects	250
2. Lifestyle	252
3. Anthropometric Measurements	259
4. Physiological Function	262
5. Physical Fitness	263
6. Teeth	264
II. Children and Adolescents (Students)	265
1. Basic Information of Subjects	265
2. Lifestyle	267
3. Anthropometric Measurements	279
4. Physiological Function	292
5. Physical Fitness	298
6. Teeth	308
7. Vision	310
III. Adults	312
1. Basic Information of the Subjects	312
2. Lifestyle	316

3. Anthropometric Measurements	331
4. Physiological Function	339
5. Physical Fitness	343
IV. Seniors	347
1. Basic Information of the Subjects	347
2. Lifestyle	351
3. Anthropometric Measurements	361
4. Physiological Function	365
5. Physical Fitness	368
<hr/>	
Part IV Appendix	371
Appendix 1: Data Registration Manual of 2020 Physical Fitness Study of Macao SAR Residents	372
I. Young Children	372
II. Children and Adolescents (Students)	397
1. Primary Students (Primary 1~3)	397
2. Primary Students (Primary 4~6)	423
3. Secondary Students (Junior Secondary 1~Senior Secondary 3)	447
4. University Students	473
III. Adults	498
1. Adults (aged 20~39)	498
2. Adults (aged 40~59)	522
IV. Seniors	546
Appendix 2: Methods for Filling out “2020 Physical Fitness Study of Macao SAR Residents” Questionnaire	570
I. Basic Information	570
1. Name and Gender	570
2. Age	570
3. Name of Attending Kindergartens, Schools, Work Units and Affiliated Units and Contact Number	570
4. Explanations	570
II. Category by Code	570
1. Macao ID Card Number	570
2. Gender	570
3. Date of Birth and Examination Date	570
4. Code Number of Kindergartens, Schools, Work Units and Affiliated Units	571
5. Serial Number	572
6. Years of Residence in Macao	572
7. Labor Intensity of Daily Work	572
8. School Grade/Academic Year	572
III. Questionnaire	572
1. Questionnaire for Young Children	573
2. Questionnaire for Children and Adolescents (Students)	579

3. Questionnaire for Adults and Seniors	583
IV. Examined Indicators	585
Appendix 3: Methods of Examining the Indicators of 2020 Physical Fitness Study of Macao SAR Residents	586
I. Anthropometric Indicators	586
1. Height	586
2. Sitting Height	587
3. Weight	588
4. Chest Circumference	588
5. Waist Circumference	589
6. Hip Circumference	589
7. Body Fat Percentage	590
8. Shoulder Width	590
9. Pelvis Width	591
10. Foot Length	591
II. Physiological Function Indicators	592
1. Resting Pulse (Heart Rate)	592
2. Blood Pressure	592
3. Vital Capacity	593
4. Step Test	594
5. Submaximal Bicycle Ergometer Exercise Test	595
6. Two-minute High-knee Running in Place	595
III. Physical Fitness Indicators	596
1. 10m Shuttle Run (Young Children)	596
2. 50m Run (Students)	597
3. 50m x 8 Shuttle Run (Students)	598
4. 800m Run (Females) or 1000m Run (Males)	599
5. Standing Long Jump	599
6. Tennis Ball Distance Throw (Young Children)	600
7. Walking on Balance Beam (Young Children)	600
8. Successive Jumps with Both Feet (Young Children)	601
9. Sit and reach	602
10. Inclined Pull-ups (Males)	602
11. Pull-ups (Males)	603
12. Vertical Jump	603
13. Grip Strength	604
14. Back Strength	604
15. One-foot Stands with Eyes Closed	605
16. Choice Reaction Time	605
17. Push-ups (Males)	606
18. One-Minute Sit-ups (Females)	606
19. 30-second Chair Stand	607

IV. Health Indicators	607
1. Dental Caries	607
2. Vision	608
3. Color Vision Deficiency Examination	610
Appendix 4: Sampling Sites of 2020 Physical Fitness Study of Macao SAR Residents	611
<hr/>	
Acknowledgement	614



Part I
**Physical Fitness Study
and Implementation**

I. Introduction

Tremendous changes have occurred in the lifestyle of humans along with social progress, countries and regions worldwide have attached unprecedentedly high importance to the physical fitness and health level of individuals and the whole society. As the most positive contributor to a healthy lifestyle, physical activity also dominates health behaviors. Our country has endeavored to promote the comprehensive and sustainable development of sports by prioritizing nationwide fitness as a national strategy to unveil the blueprints of “sporting superpower” and “healthy China”. While vigorously developing social economy, the Macao SAR Government has devoted considerable resources in sports, and proactively promoted exchanges and cooperation with Mainland China and international community to synchronize the development of national fitness and competitive sports.

Macao is a place where eastern and western cultures converge. As one of the primary modes of sports in Macao, Sport for All activity is an integral part of sports and also plays a crucial role in the sports sector of Macao. Nowadays, Sport for All activity is increasingly significant in our modern life due to its wide participation, activity diversity and various functions. As public awareness of healthy lifestyle has been constantly enhanced, the Macao SAR Government has spared no effort to promote Sport for All and integrated development of sports from all aspects, aiming to improve the physical fitness of Macao residents.

Physical fitness monitoring is not only an essential way to learn about the physical fitness status of our residents, but also a necessary means of reviewing and assessing the effectiveness of sports development, attracting great attention of the Macao SAR Government. After the first physical fitness study was initiated on Macao residents of all ages (aged 3~69) in 2005, another two physical fitness studies were conducted in 2010 and 2015 successively. In order to give full play to the scientific role of physical fitness study of residents, keep abreast of the current status of physical fitness, enrich database, establish a good foundation for dynamic observation and study on the changing patterns of the physical fitness status of Macao residents, as well as provide important scientific basis for government departments to formulate social development policies and promote physical activity to the wider public, the Sports Bureau of Macao SAR Government (hereinafter referred to as “Macao Sports Bureau”) and the China Institute of Sport Science under the General Administration of Sport of China together initiated the fourth physical fitness study for Macao residents of all ages on January 10, 2020 in collaboration with the Education and Youth Affairs Bureau (now the Education and Youth Development Bureau), the Health Bureau, the Social Welfare Bureau, the Higher Education Bureau (now merged into the Education and Youth Development Bureau), and Macao Polytechnic Institute (now Macao Polytechnic University). The test that was originally scheduled from January to April 2020, was suspended from January 23 due to the COVID-19 pandemic, and gradually resumed from July 1 with the ease of the pandemic. First, the age groups of adults and seniors were tested within two months in July and August. Afterwards, the tests for young children and students were conducted during September to November. Eventually, the entire test was completed on November 18, 2020.

II. Subjects and Methods

(I) Subjects

Subjects were Macao residents aged 3~79 and were categorized into four age groups: young children (aged 3~6), children and adolescents (students, aged 6~22), adults (aged 20~59) and seniors (aged 60~79). Young children is referred to those who have lived in Macao for at least 3 years. Students, adults and seniors are referred to those who have lived in Macao for at least 5 years.

Qualified subjects should meet the following criteria: healthy and physically well developed without congenital

or hereditary diseases such as heart disease, cerebral palsy, deaf-mutism, dementia, mental disorder, stunting, and other acute or chronic diseases such as rheumatic heart disease, hypertension, etc. The subjects must be endowed with self-caring ability, acceptable verbal skills, thinking and reception ability, as well as ability to perform basic physical activities.

(II) Sampling Principles and Methods

1. Principles

In this Study, samples were picked by stratified random and cluster sampling methods. In order to achieve longitudinal comparative study, sampling sites were selected based on the previous selected organizations in 2015.

2. Methods

The method for supplementing sampling sites was the same as that used in 2015:

(1) Young Children

Based on kindergartens (or schools) in Macao, subjects were categorized according to their locations in the parish and were divided into the following areas: 1) Nossa Senhora de Fátima (northern area) – industrial and residential region which is densely populated with many new immigrants, 2) Santo António and S.Lázaro (central area) – commercial and residential regions with comparatively dense population, 3) S. Lourenço, Sé Catedral, Nossa Senhora do Carmo and São Francisco Xavier (southern area and islands area) – tourism and gaming regions in Macao, in which Sé Catedral is the central commercial district with comparatively small population. Two kindergartens were selected randomly from each area. Young children of the same class were grouped as a unit from which subjects of appropriate ages were drawn. If those two kindergartens could not provide enough valid subjects, subjects would be randomly picked from the third randomly selected kindergarten.

(2) Children and Adolescents (Students)

Primary and secondary students: based on schools in Macao, subjects were categorized according to their locations in the parish and were divided into the following areas: 1) Nossa Senhora de Fátima (northern area) – industrial and residential which is densely populated with many new immigrants, 2) Santo António and S.Lázaro (central area) – commercial and residential regions with comparatively dense population, 3) S. Lourenço, Sé Catedral, Nossa Senhora do Carmo and São Francisco Xavier (southern area and islands area) – tourism and gaming regions in Macao, in which Sé Catedral is the central commercial district with comparatively small population. Two schools were selected randomly from each area. Students of the same class were grouped as a unit from which subjects of appropriate ages were drawn. If those two schools could not provide enough valid subjects, subjects would be randomly picked from the third randomly selected school.

University students: based on universities and colleges in Macao, the entire department was selected randomly for sampling, in which tertiary educational institutions or departments with special physical requirements were not included.

(3) Adults

Adults were divided into labor intensive and non-labor intensive workers. Based on government departments and some private institutions, N sampling sites were selected randomly. Adults of the same department were grouped as a unit from which the samples of appropriate age were drawn.

(4) Seniors

Based on senior agencies in Macao, subjects were categorized according to their locations in the parish and were divided into the following areas: 1) Nossa Senhora de Fátima (northern area) – industrial and residential which is densely populated with many new immigrants, 2) Santo António and S.Lázaro (central area) – commercial and residential regions with comparatively dense population, 3) S. Lourenço, Sé Catedral, Nossa Senhora do Carmo and São Francisco Xavier (southern area and islands area) – tourism and gaming regions in Macao, in which Sé Catedral is the central commercial district with comparatively small population. Two senior agencies were selected from each area from which the samples of appropriate ages were drawn. If those two senior agencies did not provide enough valid subjects, subjects would be randomly picked from the third randomly selected senior agency.

3. Grouping and Sample Size

(1) Young Children

Young children were grouped into two categories: male and female. Each age group differed by half a year, giving rise to 16 groups in total. 55 samples were picked from each age group, with a total sample size of 880 subjects.

(2) Children and Adolescents (Students)

Primary and secondary students were grouped into two categories: male and female. Each age group differed by one year, giving rise to 26 groups in total. 55 samples were picked from each age group, with a total sample size of 4,290 subjects.

University students were grouped into two categories: male and female. Each age group differed by one year, giving rise to 8 groups in total. 105 samples were picked from each age group, with a total sample size of 840 subjects.

(3) Adults

Adults were divided into two groups: labor intensive and non-labor intensive workers, which were further subdivided into four categories according to gender. Each age group differed by five years (i.e. aged 20~24, 25~29,...55~59). The four categories gave rise to 32 age groups in total. 105 samples were picked from each age group, with a total sample size of 3,360 subjects.

(4) Seniors

Seniors were grouped into two categories: male and female. Each age group differed by five years (i.e. aged 60~64, 65~69, 70~74, 75~79), giving rise to 8 groups in total. 105 samples were picked from each age group, with a total sample size of 840 subjects.

The total number of subjects was 10,210.

4. Calculation of Age

(1) Aged 3~6 (Young Children)

Birthday has passed for more than 6 months at the time of study:

$$\text{Age} = 2020 - \text{birth year} + 0.5$$

Birthday has passed but less than 6 month at the time of study:

$$\text{Age} = 2020 - \text{birth year}$$

Birthday will be coming in less than 6 months at the time of study:

Age = 2020 – birth year – 0.5

Birthday will be coming in more than 6 months at the time of study:

Age = 2020 – birth year – 1

(2) 6~79

Birthday has passed at the time of study: Age = 2020 – birth year

Birthday has not passed at the time of study: Age = 2020 – birth year – 1

5. Principles of Sample Selection

(1) Equal number of samples of different groups (gender, age and work categories) should be selected from all areas.

(2) Samples should be evenly distributed in each adult and senior age group, so as to avoid deviation on age distribution from affecting representativeness of samples. For example, if the total number of samples in 20~24 age groups is 105, the number of samples from ages 20, 21, 22, 23 or 24 should each be about 20.

(3) Daily labor of university students, adults and seniors were divided into labor intensive and non-labor intensive work. Labor intensive work included light physical labor (mainly referred to the work done by sitting with upper limb movements, or standing or walking most of the work time) and heavy physical labor (mainly referred to works with heavy physical activities, manual load handling or lifting, digging, etc.). Such workers generally included customer service personnel, sales personnel and personnel with similar work nature, skilled agricultural and fishery workers, craftspersons and artisans, machine operators, drivers and assemblers, and non-technicians etc. Non-labor intensive work mainly referred to sedentary work, and related occupations generally included legislative officers, public administration officers, community leaders and managers, professionals, technicians or professional assistants, and office clerks etc. **(Refer to “Occupational Classification” in Appendix 2 of Part IV).**

(III) Examined Variables

This study was composed of physique examination and questionnaire. Physique examination included anthropometric measurements, functional and physical fitness indicators. Whereas dental caries was also examined in young children, and dental caries, eyesight and colour vision were examined in students. Information on demographic characteristics and scientific fitness literacy were obtained from questionnaire **(Refer to Appendix 1 to Part IV).**

1. Indicators of Inquiry

Indicators of inquiry were mainly performed by questionnaires which included:

I. Young Children (aged 3~6)

▲ Personal Information of Young Child

1. Macao ID card number
2. Gender
3. Date of birth
4. Examination date (to be filled in by examiner)
5. Kindergarten code number (to be filled in by examiner)
6. Serial number (to be filled in by examiner)

7. Years of residence in Macao (It refers to years of continuous residence in Macao. If the child had left Macao for over 1 year, years of residence in Macao should be recalculated from the time of returning to Macao.)
8. Place of birth
9. Parish of residence
10. Birth weight
11. Birth length
12. Gestational age
13. Feeding pattern within four months after birth
14. Hospital-diagnosed diseases
15. Diseases suffered (in order of precedence, choose up to three diseases)
16. Do you have any sibling(s)?
17. Do you have Any congenital disease or disability that affects physical activity?
18. Kindergarten attendance
19. Caregiver at home
20. Does your child brush teeth every day?
21. Does your child use dental floss in addition to tooth-brushing every day?
22. Did your child go to a dental clinic for dental examination within the past 12 months?
23. Does your child have any decayed tooth?
24. If yes, has your child visited a dental clinic for treatment?
25. Does your child live with his/her parents?

▲ Paternal and Maternal Personal Information

1. Date of birth
2. Place of birth
3. Years of residence in Macao
4. Height
5. Weight
6. Education level
7. Current occupation

▲ Fitness Literacy of Young Child (to be filled in by parents)

A - Attitude and skill

1. Please choose from the following descriptions according to your understanding of your child [My child prefers outdoor activities; My child has few friends to play with (except those in kindergarten); My child likes to play with older children; My child likes to participate in team activities].
2. What kind of physical exercises does your child frequently participate?
3. What are the physical exercises your child is good at?

B - Exercise habits

1. On school days (Monday through Friday), what is the average time your child spends on physical exercises

- per day (including out-of-school time playing in the park, and exercising at school, care center, or home)?
2. On rest days (Saturdays, Sundays, or holidays), what is the average time your child spends on physical exercises per day (including time playing in the park, attending extracurricular hobby classes, or exercising at home)?
 3. Has your child signed up for any training classes chiefly related to physical exercise (e.g. dancing class and football class are training classes related to physical exercise, whereas calligraphy class and piano class are not)?
 4. What is the average time your child spends on the training class(es) mentioned above in a typical week?
 5. On school days (Monday through Friday), what is the average daily time your child spends on watching TV and using electronic devices such as mobile/computers/laptop computers?
 6. On rest days (Saturdays, Sundays, or holidays), what is the average daily time your child spends on watching TV and using electronic devices such as mobile/computers/laptop computers?
 7. On school days (Monday through Friday), what is the average nap time of your child?
 8. On school days (Monday through Friday), what is the average sleep time of your child at night?
 9. On rest days (Saturdays, Sundays, or holidays), what is the average nap time of your child?
 10. On rest days (Saturdays, Sundays, or holidays), what is the average sleep time of your child at night?

C - Personal traits and home environment

1. Please choose from the following descriptions according to your understanding of your child (My child is physically active; My child likes activities that are relatively quiet; My child is cautious with others; My child prefers staying alone).
2. Do you think your child has adequate amount of exercise currently compared to peers?
3. How would you describe your child's current exercise ability compared to peers?
4. What is the exercise frequency of the child's father?
5. What is the exercise frequency of the child's mother?
6. Are you willing to spend money on your child to participate in physical exercise?
7. On rest days (Saturdays, Sundays, or holidays), what is the average daily screen time (such as TV, mobile, laptop, game console) of the child's father?
8. On rest days (Saturdays, Sundays, or holidays), what is the average daily screen time (such as TV, mobile, laptop, game console) of the child's mother?
9. What kind of entertainment products does your child always play at home?
10. How would you describe your child's weight?
11. Which of the following description is accurate? (I encourage and choose physical exercises based solely on my child's preferences; I purposefully encourage and select physical exercises for my child according to his/her weaknesses (such as personality and skills); I choose the proper physical exercises for my child according to my understanding of various physical exercises.)
12. Which of the following description is accurate, when "the physical exercise that you think is appropriate is dislike by your child"? (I will allow my child to quit; I will let my child hold on for a while before making a decision; I will insist that my child should keep participating if I think it is good for him/her.)
13. On rest days (Saturdays, Sundays, or holidays), what is the daily average time the child's father or mother spent on playing outside with the child?

14. What kind of rules and requirements do you have for your child's activities, both indoors and outdoors?
15. According to your understanding and attitude of physical exercise, which of the following description is accurate? (As for exercise performance, skills or other aspects, I like to compete with others, and enjoy the pleasure of having better performance than others; Winning is the most important part in sports competitions and it makes me feel great; I have found the meaning of physical exercise through competition; I feel very accomplished if I have sports skills that no one else has; I have learned a lot of new things through physical exercise and the process is very interesting; I will try my best to practice the new things I have learned in sports activities).

D - Community environment

1. Is it convenient for you to go to recreational facilities such as park or shopping mall nearest to your home?
2. Is it safe for children to play or do physical exercises around your residence?
3. How would you describe your residential environment (such as greening and sanitation)?
4. What are the three main residential environmental factors that limit your child's outdoor activities in your opinion?

II. Children and Adolescents (Primary 1~3)

▲ Personal Information of Student

1. Macao ID card number
2. Gender
3. Date of birth
4. Examination date (to be filled in by examiner)
5. School code number (to be filled in by examiner)
6. Serial number (to be filled in by examiner)
7. Years of residence in Macao (It refers to years of continuous residence in Macao. If the subject had left Macao for over 1 year, years of residence in Macao should be recalculated from the time of returning to Macao.)
8. School grade
9. Place of birth
10. Parish of residence
11. Hospital-diagnosed diseases suffered within the past 5 years
12. Diseases suffered (in order of precedence, choose up to three diseases)
13. Do you brush teeth every day?
14. Do you use dental floss in addition to tooth-brushing every day?
15. Did you go to a dental clinic for dental examination within the past 12 months?
16. Do you have any decayed tooth?
17. If yes, have you visited a dental clinic for treatment?
18. Do you have any sibling(s)?
19. Do you have any congenital disease or disability that affects physical activity?
20. Do you live with your parents?

▲ Fitness Literacy

Part 1 Questions to be answered by child independently

1. Which of the following description do you (child) think is correct? (Take a rest after meal before exercising; Warm up properly before exercising; Take a rest when there is muscle cramp during exercising; Put on sports shoes before exercising.)
2. Do you (child) like physical exercise?
3. Please rate for your own performance in physical education (PE) class. On a scale from 0 to 10, with 10 scores for the best and 0 for the worst, how many scores will you (child) get?
4. Do you (child) like to play no matter at school or going out with your family?
5. Do you (child) think you are always energetic and physically active?
6. Do you (child) think you can get to know a lot of new friends by taking part in physical exercise?
7. What do you (child) think are the benefits of taking part in physical exercise?
8. What kind of physical exercises have you (child) tried?
9. What kind of physical exercises can you (child) do?
10. Why are you (child) able to do the physical exercises you have chosen in the previous question?
11. Do you (child) think you have any shortcoming that affects you to do some exercise, such as being not good at playing basketball due to short in height?
12. Do you (child) think you are fat?
13. Does your father accompany you (child) to do outdoor activities organized on or off campus?
14. Does your mother accompany you (child) to do outdoor activities organized on or off campus?
15. What kind of entertainment products do you (child) often play at home?
16. Does your mom or dad often encourage you (child) to participate in physical exercise?
17. Does your mom or dad give you (child) a time limit for playing outside?
18. Are you (child) satisfied with your performance in PE class at school?
19. How would you (child) describe your exercise ability?
20. Will you (child) continue to use the skills and knowledge learned in PE class in your extracurricular or after-school physical exercise?
21. Do you (child) like your PE class at school?
22. What are the reasons you (child) do not like or are not interested in your PE class at school?

Part 2 Questions to be answered by child with assistance of parents

1. In the recent month, do you (child) often go outside to participate in various physical exercises (including playing outdoors or at outdoor playground at school)?
2. On weekends (Saturdays and Sundays) in the recent month, what is the average daily time you (child) spends on outdoor exercises?
3. On school days (Monday through Friday), what is the average daily time you (child) spends watching TV and using electronic devices such as mobile/computers/laptop computers?
4. On rest days (Saturdays, Sundays, or holidays), what is the average daily time you (child) spends watching TV and using electronic devices such as mobile/computers/laptop computers?
5. What kind of physical exercises have you (child) been doing consistently in the recent year (including PE

- class, extracurricular exercise and after-school exercise)?
6. Have you (child) participated in tutoring or any non-sports training or hobby classes (such as painting, music, and calligraphy classes) outside school in the recent half year?
 7. What is the average time you (child) spends on the training or hobby classes mentioned above in a typical week?
 8. How many PE classes do you (child) take in a typical week this semester (if two PE classes are arranged consecutively, count as one; if not, count as two)?
 9. How long is each PE class you (child) take?
 10. Generally speaking, how do you (child) feel physically when exercising in PE class?
 11. In addition to PE classes in school, what is your (child's) average frequency of doing physical exercise (including extracurricular exercise and after-school exercise) in a typical week in the recent month?
 12. Generally speaking, what is your (child's) average duration of physical exercise (such as extracurricular exercise and after-school exercise) each time, in addition to PE classes in school?
 13. Generally speaking, how do you (child) feel physically when exercising (such as extracurricular exercise and after-school exercise), in addition to PE classes in school?
 14. How many days in a week do you (child) do strength exercises (including bodyweight training such as push-ups, sit-ups, pull-ups, and squats; or equipment workout such as using dumbbells and elastic bands)?
 15. Does your (child's) father often exercise?
 16. Does your (child's) mother often exercise?
 17. What does your (child's) father most frequently do when he is not at work?
 18. What does your (child's) mother most frequently do when she is not at work?
 19. Is your (child's) home near a park or a mall?
 20. Is it safe for you (child) to play in the surroundings of your residence?
 21. Do you (child) know any friends that you can play with in the surroundings of your residence?
 22. Do you (child) play in the surroundings of your residence on rest days (Saturdays, Sundays, or holidays)?
 23. What are the reasons you (child) do not play in the surroundings of your residence on rest days (Saturdays, Sundays, or holidays)?
 24. On school days (Monday through Friday), what is your (child's) average sleep time (including naps) per day?
 25. On rest days (Saturdays, Sundays, or holidays), what is your (child's) average sleep time (including naps) per day?
 26. What is your (child's) average sitting or reclining time (including the sitting time for school classes, homework, watching TV, using computers, eating, and transportation) per day?

Part 3 Questions to be answered by parents

1. Please choose from the following descriptions according to your understanding of your child (My child is physically active; My child likes activities that are relatively quiet; My child is cautious with others; My child prefers staying alone; My child likes to compete with others; My child is easily pleased).

2. Do you think your child has adequate amount of exercise currently?
3. What is your exercise frequency?
4. Are you willing to spend money on your child to participate in physical exercise (such as attending football classes, dancing classes; or buying exercise devices, professional equipments, etc.)?
5. Is your child's father fat?
6. Is your child's mother fat?

III. Children and Adolescents (Primary 4~6)

▲ Personal Information of Student

1. Macao ID card number
2. Gender
3. Date of birth
4. Examination date (to be filled in by examiner)
5. School code number (to be filled in by examiner)
6. Serial number (to be filled in by examiner)
7. Years of residence in Macao (It refers to years of continuous residence in Macao. If the subject had left Macao for over 1 year, years of residence in Macao should be recalculated from the time of returning to Macao.)
8. School grade
9. Place of birth
10. Parish of residence
11. Hospital-diagnosed diseases suffered within the past 5 years
12. Diseases suffered (in order of precedence, choose up to three diseases)
13. Do you brush teeth every day?
14. Do you use dental floss in addition to tooth-brushing every day?
15. Did you go to a dental clinic for dental examination within the past 12 months?
16. Do you have any decayed tooth?
17. If yes, have you visited a dental clinic for treatment?
18. Do you have any sibling(s)?
19. Do you have any congenital disease or disability that affects physical activity?
20. Do you live with your parents?

▲ Fitness Literacy

A - Fitness knowledge (to be answered by student independently)

1. Which of the following descriptions do you think are correct? (During strenuous exercise, you should only breathe through the nose; Take a rest immediately when there is muscle cramp during exercising; Do necessary stretching before exercising; When running round the bend, incline your body to the inside of the track; You can eat immediately after exercising; You should not eat too much before exercising; After exercising, you can eat more vegetables and fruits to relieve fatigue; To do a crouch start, when hearing the command "Get set", you should raise the hip, and move the body's center of gravity forward at the

same time to form a body posture with hips higher than shoulders and shoulders exceeding the starting line; To do a standing forward bend, you should keep both legs standing together, with straight knees and upper body close to legs as much as possible; To do a high-knee running in place, you should keep a fast pace and lean back the body slightly.)

B - Fitness attitude (to be answered by student independently)

1. Which of the following descriptions do you agree with? (Doing physical exercises can strengthen our body; Doing physical exercises helps to reduce fat and avoid obesity; Doing physical exercises can improve self-confidence; Doing physical exercises can help us to make more friends.)
2. Which of the following descriptions is accurate according to your situation? (Doing physical exercises is very useful; Doing physical exercises is very boring; Doing physical exercises is harmful to my body; the experience of exercising is not pleasant.)
3. Which of the following descriptions is accurate according to your situation? [It is very difficult for me to complete the required tasks in PE class; Parents or those who are important to me (such as grandpa, grandma, classmates and friends) would not ask me to do physical exercises; I can meet all the required indicators of physical exercises if I want to.]
4. Which of the following descriptions is accurate according to your situation? (As I saw my classmates or friends doing physical exercise, I want to join them; I'm able to keep on exercising; I have made a physical exercise plan for myself.)

C - Fitness skills (to be answered by student independently)

1. What kind of physical exercises have you tried?
2. What kind of physical exercises are you proficient in? (Proficiency means that you have perfectly acquired a basic exercise skill.)
3. What kind of warm-up exercises are you proficient in? (Proficiency means that you can do warm-up exercises on your own.)
4. Which of the following exercise injuries can you handle correctly?
5. If the knee is skinned during exercise, what is the best way to handle it?

D - Fitness habits (to be answered by student independently)

1. How many PE classes do you take in a typical week this semester (if two PE classes are arranged consecutively, count as one; if not, count as two)?
2. How long is each PE class you take?
3. Generally speaking, how do you feel physically when exercising in PE class?
4. In addition to PE classes in school, what is your average frequency of physical exercise (including extracurricular exercise and after-school exercise) in a typical week in the recent month?
5. Generally speaking, what is your average duration of exercising (such as extracurricular exercise and after-school exercise) each time, in addition to PE class in school?
6. Generally speaking, how do you feel physically when exercising (such as extracurricular exercise and after-school exercise), in addition to PE class in school?
7. How many days of a week do you usually do strength exercises (including bodyweight training such as push-ups, sit-ups, pull-ups, and squats; or equipment workout such as using dumbbells and elastic

bands)?

8. What kind of physical exercises have you been doing consistently in the recent year (including PE class, extracurricular exercise and after-school exercise)?
9. Among the physical exercises chosen in the above Question D8, taking the one with the longest duration as an example, how long have you been doing it?
10. Among the physical exercises chosen in the above Question D8, what is the main reason that keeps you in doing these?
11. How did you choose the physical exercises in Question D8?

E - Other habits (to be answered by student with assistance of parents)

1. What is your average sitting or reclining time (including the sitting time for school classes, homework, watching TV, using computers, eating, and transportation) per day?
2. On school days (Monday through Friday), what is your average sleep time (including naps) per day?
3. On rest days (Saturdays, Sundays, or holidays), what is your average sleep time (including naps) per day?
4. On school days (Monday through Friday), what is the average daily time you spend on watching TV and using electronic devices such as mobiles/computers/laptop computers?
5. On rest days (Saturdays, Sundays, or holidays), what is the average daily time you spend on watching TV and using electronic devices such as mobiles/computers/laptop computers?

IV. Children and Adolescents (Junior Secondary 1~Senior Secondary 3)

▲ Personal Information of Student

1. Macao ID card number
2. Gender
3. Date of birth
4. Examination date (to be filled in by examiner)
5. School code number (to be filled in by examiner)
6. Serial number (to be filled in by examiner)
7. Years of residence in Macao (It refers to years of continuous residence in Macao. If the subject had left Macao for over 1 year, years of residence in Macao should be recalculated from the time of returning to Macao.)
8. School grade
9. Place of birth
10. Parish of residence
11. Hospital-diagnosed diseases suffered within the past 5 years
12. Diseases suffered (in order of precedence, choose up to three diseases)
13. Do you brush teeth every day?
14. Do you use dental floss in addition to tooth-brushing every day?
15. Did you go to a dental clinic for dental examination within the past 12 months?
16. Do you have any decayed tooth?
17. If yes, have you visited a dental clinic for treatment?
18. Do you have any sibling(s)?

19. Do you have any congenital disease or disability that affects physical activity?

20. Do you live with your parents?

▲ Fitness Literacy (to be answered by student independently)

A - Fitness knowledge

1. Which of the following descriptions do you think are correct? (Anemia patients should do more physical exercises; Warm up before swimming each time; During strenuous exercise, you should only breathe through the nose; Skinny person should choose exercises targeted to improve muscle strength, such as push-ups, horizontal and parallel bars, lifting dumbbells, etc.; When running round the bend, you should incline your body to the inside of the track; The Winter Olympics are held once every four years; Cycling is an anaerobic exercise; To complete a long jump, you should push both balls of your feet off the ground vigorously to push your body up; Standing forward bend is a body weight training to practice sit and reach, in which you have to keep both legs standing together with straight knees and bend forward the upper body with both palms touching the ground, and keep the upper body close to legs as much as possible; To do a high-knee running in place, you should keep a fast pace and lean back the body slightly.)

B - Fitness attitude

1. Which of the following descriptions do you agree with? (Doing physical exercises can strengthen our body; Doing physical exercises can lose weight; Doing physical exercises can improve self-confidence; Doing physical exercises can help us to meet more friends; Doing physical exercises can temper your willpower.)
2. Which of the following descriptions is accurate according to your situation? (Doing physical exercises is very useful; Doing physical exercises is very boring and it is just a waste of time; Doing physical exercises may cause injuries; The experience of exercising is not pleasant; I'll be too tired to do other things after exercising.)
3. Which of the following descriptions is accurate according to your situation? [It is difficult for me to learn the sport skills taught in PE class; Parents or those who are important to me (such as grandpa, grandma, classmates, friends and teachers) often encourage me to do physical exercise; I can meet all the required indicators of physical exercises if I want to; I can keep on exercising if I want to; I think the sport skills that I acquired are correct and scientific.]
4. Which of the following descriptions is accurate according to your situation? [I'll follow my classmate to do some physical exercise; I have already made up my mind to keep on exercising; I have prepared or am preparing a rough plan for physical exercise (including ideas); I have visited or am planning to consult with sports and fitness professionals (e.g., PE teachers, fitness coaches, TV shows) and get their professional advice.]

C - Fitness skills

1. What kinds of physical exercises have you tried?
2. What kind of physical exercises are you proficient in? (Proficiency means that you have perfectly acquired the basic skills and competition rules of a physical exercise.)
3. What kind of warm-up exercises are you proficient in? (Proficiency means that you can do a warm-up exercise on your own)
4. Which of the following exercise injuries can you handle correctly?

5. If the knee is skinned during exercise, what is the best way to handle it?
6. Which of the following ways do you think you can access more scientific and professional sports and fitness information?

D - Fitness habits

1. How many PE classes do you take in a typical week this semester (if two PE classes are arranged consecutively, count as one; if not, count as two)?
2. How long is each PE class you take?
3. Generally speaking, how do you feel physically when exercising in PE class?
4. In addition to PE classes in school, what is your average frequency of exercising (including extracurricular exercise and after-school exercise) in a typical week in the recent month?
5. Generally speaking, what is your average duration of exercising (such as extracurricular exercise and after-school exercise) each time, in addition to PE class in school?
6. Generally speaking, how do you feel physically when exercising (such as extracurricular exercise and after-school exercise), in addition to PE class in school?
7. How many days of a week do you usually do strength exercises (including bodyweight training such as push-ups, sit-ups, pull-ups, and squats; or equipment workout such as using dumbbells and elastic bands)?
8. What kind of physical exercises have you been doing consistently in the recent year (including PE class, extracurricular exercise and after-school exercise)?
9. Among the physical exercises chosen in the above Question D8, taking the one with the longest duration as an example, how long have you been doing it?
10. Among the physical exercises chosen in the above Question D8, what is the main reason that keeps you in doing these?
11. How did you choose the physical exercises chosen in Question D8?

E - Other habits

1. What is your average sitting or reclining time (including the sitting time for school classes, homework, watching TV, using computers, eating, and transportation) per day?
2. On school days (Monday through Friday), what is your average sleep time (including naps) per day?
3. On rest days (Saturdays, Sundays, or holidays), what is your average sleep time (including naps) per day?
4. On school days (Monday through Friday), what is the average daily time you spend on watching TV and using electronic devices such as mobiles/computers/laptop computers?
5. On rest days (Saturdays, Sundays, or holidays), what is the average daily time you spend on watching TV and using electronic devices such as mobiles/computers/laptop computers?

V. Children and Adolescents (University Students)

▲ Personal Information of Student

1. Macao ID card number
2. Gender
3. Date of birth

4. Examination date (to be filled in by examiner)
5. School code number (to be filled in by examiner)
6. Serial number (to be filled in by examiner)
7. Years of residence in Macao (It refers to years of continuous residence in Macao. If the subject had left Macao for over 1 year, years of residence in Macao should be recalculated from the time of returning to Macao.)
8. Academic year
9. Labor intensity of daily work
10. Place of birth
11. Parish of residence
12. Hospital-diagnosed diseases suffered within the past 5 years
13. Diseases suffered (in order of precedence, choose up to three diseases)
14. Do you brush teeth every day?
15. Do you use dental floss in addition to tooth-brushing every day?
16. Did you go to a dental clinic for dental examination within the past 12 months?
17. Do you have any decayed tooth?
18. If yes, have you visited a dental clinic for treatment?

▲ Fitness Literacy

A - Knowledge, cognition and attitude

1. Which of the following descriptions do you think are correct? (Morning is the best time for exercise; High-intensity exercise is good for losing weight; You should take a rest for about 30 minutes after eating before going for a walk; You should choose hard and flat ground when running; Rope skipping can prevent osteoporosis; It is best to wear pure cotton clothing during exercise; You should not eat right after swimming; Exercise prescription is a therapy to specify the content and amount of exercise in the form of prescription, according to the physical condition of a target group; Abdominal breathing refers to the breathing method of inhaling deeply to fill the chest and bulging belly with air, and then exhaling deeply; Aerobic exercise is a kind of rhythmic physical exercise with low intensity and long duration under the condition of sufficient oxygen supply, such as swimming and jogging.)
2. Which of the following descriptions do you agree with? (Generally speaking, fitness activity is positive; Doing fitness activities is good for body health; Doing fitness activities can relieve anxiety or irritability; Doing fitness activities can enhance our perseverance; Doing fitness activities is boring; Fitness activity is well worth doing; Doing fitness activities is a part of my life I can live without; We should spare time for fitness activities no matter how busy we are; Spending money on fitness activities is worthwhile; I would like to persuade others to work out with me.)
3. Which of the following descriptions is accurate according to your situation? [I think the motor skills that I acquired are correct and scientific; I have visited or am planning to consult with sports and fitness professionals (e.g., PE teachers, fitness coaches, TV shows) and get their professional advice.]

B - Fitness skills

1. What are the physical exercises that you frequently participate? (Choose your main physical exercises in descending order of frequency)

2. What kind of physical exercises are you proficient in? (Proficiency means that you have perfectly acquired the basic skills and competition rules of a physical exercise) (Choose your main physical exercises in order of proficiency)
3. What kind of warm-up exercises should be done before exercising?
4. What kind of warm-up exercises are you proficient in? (Proficiency means that you can do warm-up exercise on your own)
5. Which of the following descriptions is accurate according to your situation? (I can choose proper physical exercise programs that suit me; I can reasonably prepare a fitness plan based on my actual condition; I can promptly adjust my fitness plan based on my actual condition.)
6. Which of the following descriptions is accurate according to your situation? (I think I have perfectly acquired the skills of my favorite fitness programme; I can keep on doing fitness workouts if I want to.)

C - Habit formation

1. How did you choose the physical exercises in Question B1?
2. What are the main obstacles refrain you from exercising? (Circle the top 3 reasons in order of precedence)
3. How is your current work status? (i.e. your work activities, including volunteer works, but not including houseworks)
4. What is the labor intensity of your daily work? [How many days in a typical week do you do vigorous activities (e.g. manual load handling or lifting, digging or construction work) lasting for more than 10 minutes with “significantly increased breathing and heart rate”? What is the average cumulative time you spend on doing such vigorous activities lasting for more than 10 minutes at work on a typical day? How many days in a typical week do you do moderate-intensity activities (e.g. brisk walking, manual handling of light objects) lasting for more than 10 minutes with “slightly increased breathing and heart rate”? What is the average cumulative time you spend on doing such moderate-intensity activities lasting for more than 10 minutes at work on a typical day?
5. What is your average sitting or reclining time per day?
6. What is your average sleep time (including naps) per day?
7. What is your major means of transportation?
8. How many days do you walk or cycle for at least 10 minutes continuously in a typical week? (It refers to the total time spent on commuting from home to school, or from classroom to dormitory, shopping and attending parties, etc., but not including walking or cycling specifically for physical exercise); What is the average cumulative commuting time you spend on walking or cycling for at least 10 minutes continuously on a typical day?
9. What is the labor intensity of your daily house chores? [How many days in a typical week do you do high-intensity house chores (e.g. manual load handling or lifting, digging in the yard, etc.) lasting for more than 10 minutes? What is the average cumulative time you spend on doing such high-intensity house chores lasting for more than 10 minutes in a typical day? How many days in a typical week do you do moderate-intensity house chores (e.g. handling or lifting light objects, wiping windows, mopping floor, cleaning rooms, etc.) lasting for more than 10 minutes? What is the average cumulative time you spend on doing such moderate-intensity house chores lasting for more than 10 minutes in a typical day?]
10. What kind of leisure-time activities do you usually do? (Choose 3 activities you most frequently do in descending order of time spent)

11. What is your exercise frequency?
12. What is your exercise duration each time in most cases?
13. In most cases, how do you feel physically during exercising?
14. What are your actual conditions when you do physical exercises each week? (How many days in a typical week do you do high-intensity physical exercises lasting for more than 10 minutes with significantly increased breathing, heart rate and sweating? How many times per day on average? How many minutes each time on average? How many days in a typical week do you do moderate-intensity physical exercises lasting for more than 10 minutes with slightly increased breathing & heart rate and slight sweating? How many times per day on average? How many minutes each time on average?)
15. How long have you kept on exercising as per the exercise frequency, duration and intensity chosen in Questions C11~C14?
16. How many days of a week do you usually do strength exercises (including bodyweight training such as push-ups, sit-ups, pull-ups, and squats; or equipment workout such as using dumbbells and elastic bands)?

VI. Adults (aged 20~39 and 40~59)

▲ Personal Information

1. Macao ID card number
2. Gender
3. Date of birth
4. Examination date (to be filled in by examiner)
5. Work unit code number (to be filled in by examiner)
6. Serial number (to be filled in by examiner)
7. Years of residence in Macao (It refers to years of continuous residence in Macao. If the subject had left Macao for over 1 year, years of residence in Macao should be recalculated from the time of returning to Macao.)
8. Labor intensity of daily work
9. Place of birth
10. Parish of residence
11. Education level
12. Current occupation
13. Hospital-diagnosed diseases suffered within the past 5 years
14. Diseases suffered (in order of precedence, choose up to three diseases)
15. Have you ever heard of the “Physical Fitness Study”?
16. Have you ever participated in the “Physical Fitness Study”?
17. What is your understanding of the “Physical Fitness Study”? (in order of precedence, at most three items)

▲ Fitness Literacy

A - Knowledge, cognition and attitude

1. Which of the following descriptions do you think are correct? (Morning is the best time for exercise; High-intensity exercise is good for losing weight; You should take a rest for about 30 minutes after eating before going for

a walk; You should choose hard and flat ground when running; Rope skipping can prevent osteoporosis; It is best to wear pure cotton clothing during exercise; You should not eat right after swimming; Exercise prescription is a therapy to specify the content and amount of exercise in the form of prescription, according to the physical condition of a target group; Abdominal breathing refers to the breathing method of inhaling deeply to fill the chest and bulging belly with air, and then exhaling deeply; Aerobic exercise is a kind of rhythmic physical exercise with low intensity and long duration under the condition of sufficient oxygen supply, such as swimming and jogging.)

2. Which of the following descriptions do you agree with? (Generally speaking, fitness activity is positive; Doing fitness activities is good for body health; Doing fitness activities can relieve anxiety or irritability; Doing fitness activities can enhance our perseverance; Doing fitness activities is boring; Fitness activity is well worth doing; Doing fitness activities is a part of my life I can live without; We should spare time for fitness activities no matter how busy we are; Spending money on fitness activities is worthwhile; I would like to persuade others to work out with me.)
3. Which of the following descriptions is accurate according to your situation? [I think the sport skills that I acquired are correct and scientific; I have visited or am planning to consult with sports and fitness professionals (e.g., PE teachers, fitness coaches, TV shows) and get their professional advice.]

B - Fitness skills

1. What are the physical exercises that you frequently participate? (Choose your main physical exercises in descending order of frequency)
2. What kind of physical exercises are you proficient in? (Proficiency means that you have perfectly acquired the basic skills and competition rules of a physical exercise) (Choose your main physical exercises in order of proficiency)
3. What kind of warm-up exercises should be done before exercising?
4. What kind of warm-up exercises are you proficient in? (Proficiency means that you can do warm-up exercise on your own)
5. Which of the following descriptions is accurate according to your situation? (I can choose proper physical exercise programs that suit me; I can reasonably prepare a fitness plan based on my actual condition; I can promptly adjust my fitness plan based on my actual condition.)
6. Which of the following descriptions is accurate according to your situation? (I think I can perfectly master the skills required by my favorite fitness program; I can keep on doing fitness workouts if I want to.)

C - Habit formation

1. How did you choose the physical exercises in Question B1?
2. What are the main obstacles for you to participate in physical exercise? (Circle the top 3 reasons in order of precedence)
3. What is your current work status? (i.e. your professional activities, including volunteer work, but not including house chores)
4. What is the labor intensity of your daily work? [How many days in a typical week do you do vigorous activities (e.g. manual load handling or lifting, digging or construction work) lasting for more than 10 minutes with “significantly increased breathing and heart rate”? What is the average cumulative time you spend on doing such vigorous activities lasting for more than 10 minutes at work in a typical day? How many days in a typical week do you do moderate-intensity activities (e.g. brisk walking, manual handling of light

- objects) lasting for more than 10 minutes with “slightly increased breathing and heart rate”? What is the average cumulative time you spend on doing such moderate-intensity activities lasting for more than 10 minutes at work in a typical day?
5. What is your average sitting or reclining time per day?
 6. What is your average sleep time (including naps) per day?
 7. What is your major means of transportation?
 8. How many days do you walk or cycle for at least 10 minutes continuously in a typical week? (It refers to the total time spent on commuting to work, shopping and attending parties, etc., but do not include walking or cycling specifically for physical exercise); What is the average cumulative commuting time you spend on walking or cycling at least 10 minutes continuously in a typical day?
 9. What is the labor intensity of your daily house chores? [How many days in a typical week do you do high-intensity house chores (e.g. manual load handling or lifting, digging in the yard, etc.) lasting for more than 10 minutes? What is the average cumulative time you spend on doing such high-intensity house chores lasting for more than 10 minutes in a typical day? How many days in a typical week do you do moderate-intensity house chores (e.g. handling or lifting light objects, wiping the window, mopping the floor, cleaning the room, etc.) lasting for more than 10 minutes? What is the average cumulative time you spend on doing such moderate-intensity house chores lasting for more than 10 minutes in a typical day?]
 10. What kind of leisure-time activities do you usually do? (Choose 3 activities you most frequently do in descending order of time spent)
 11. What is your exercise frequency?
 12. What is your exercise duration each time in most cases?
 13. In most cases, how do you feel physically during exercising?
 14. What are your actual conditions when you do physical exercises each week? (How many days in a typical week do you do high-intensity physical exercises lasting for more than 10 minutes with significantly increased breathing, heart rate and sweating? How many times per day on average? How many minutes each time on average? How many days in a typical week do you do moderate-intensity physical exercises lasting for more than 10 minutes with slightly increased breathing & heart rate and slight sweating? How many times per day on average? How many minutes each time on average?)
 15. How long have you kept on exercising as per the exercise frequency, duration and intensity chosen in Questions C11~C14?
 16. How many days of a week do you usually do strength exercises (including bodyweight training such as push-ups, sit-ups, pull-ups, and squats; or equipment workout such as using dumbbells and elastic bands)?

VII. Seniors (aged 60~79)

▲ Personal Information

1. Macao ID card number
2. Gender
3. Date of birth
4. Examination date (to be filled in by examiner)
5. Senior agency code number (to be filled in by examiner)

6. Serial number (to be filled in by examiner)
7. Years of residence in Macao (It refers to years of continuous residence in Macao. If the subject had left Macao for over 1 year, years of residence in Macao should be recalculated from the time of returning to Macao.)
8. Labor intensity of daily work
9. Place of birth
10. Parish of residence
11. Education level
12. Retirement status
13. Occupation before retirement/current occupation
14. Hospital-diagnosed diseases suffered within the past 5 years
15. Diseases suffered (in order of precedence, choose up to three diseases)
16. Have you ever heard of “Physical Fitness Study”?
17. Have you ever participated in “Physical Fitness Study”?
18. What is your understanding of “Physical Fitness Study”? (in order of precedence, at most three items)

▲ Fitness Literacy

A - Knowledge, cognition and attitude

1. Which of the following descriptions do you think are correct? (Morning is the best time for exercise; Physical exercise helps to reduce the risks of falling and fall-related fractures in the elderly; You should take a rest for about 30 minutes after eating before going for a walk; Choose hard and flat ground when running; Patients of any acute heart diseases or other acute diseases with increased body temperature, such as acute myocardial infarction, upper respiratory tract infection and fever, should not participate in physical exercise; It is best to wear pure cotton clothing during exercise; You should not eat right after swimming; Exercise prescription is a therapy to specify the content and amount of exercise in the form of prescription, according to the physical condition of a target group; Weight training such as running, brisk walking and rope skipping can strengthen bone density, preventing osteoporosis and bone fractures; Aerobic exercise is a kind of rhythmic physical exercise with low intensity and long duration under the condition of sufficient oxygen supply, such as swimming and jogging).
2. Which of the following descriptions do you agree with? (Generally speaking, fitness activity is positive; Doing fitness activities is good for body health; Doing fitness activities can relieve anxiety or depression; Doing fitness activities can enhance our perseverance; Doing fitness activities is boring; Fitness activity is well worth doing; Doing fitness activities is a part of my life I can live without; We should spare time for fitness activities no matter how busy we are; Spending money on fitness activities is worthwhile; I would like to persuade others to work out with me.)
3. Which of the following descriptions is accurate according to your situation? [I think the sports skills that I acquired are correct and scientific; I have visited or am planning to consult with sports and fitness professionals (e.g., PE teachers, fitness coaches, TV shows) and get their professional advice.]

B - Fitness skills

1. What are the physical exercises that you frequently participated? (Choose your main physical exercises in descending order of frequency)

2. What kind of physical exercises are you proficient in? (Proficiency means that you have perfectly acquired the basic skills and competition rules of a physical exercise) (Choose your main physical exercises in order of proficiency)
3. What kind of warm-up exercises should be done before exercising?
4. What kind of warm-up exercises are you proficient in? (Proficiency means that you can do warm-up exercise on your own)
5. Which of the following descriptions is accurate according to your situation? (I can choose proper physical exercise programs that suit me; I can reasonably prepare a fitness plan based on my actual condition; I can promptly adjust my fitness plan based on my actual condition.)
6. Which of the following descriptions is accurate according to your situation? (I think I can perfectly master the skills required by my favorite fitness program; I can keep on doing fitness workouts if I want to.)

C - Habit formation

1. How did you choose the physical exercises in Question B1?
2. What are the main obstacles refrain you from participating in physical exercise? (Circle the top 3 reasons in order of precedence)
3. What is your current work status? (i.e. your professional activities, including volunteer work, but not including house chores)
4. What is the labor intensity of your daily work? [How many days in a typical week do you do vigorous activities (e.g. manual load handling or lifting, digging or construction work) lasting for more than 10 minutes with “significantly increased breathing and heart rate”? What is the average cumulative time you spend on doing such vigorous activities lasting for more than 10 minutes at work in a typical day? How many days in a typical week do you do moderate-intensity activities (e.g. brisk walking, manual handling of light objects) lasting for more than 10 minutes with “slightly increased breathing and heart rate”? What is the average cumulative time you spend on doing such moderate-intensity activities lasting for more than 10 minutes at work in a typical day?
5. What is your average sitting or reclining time per day?
6. What is your average sleep time (including naps) per day?
7. What is your major means of transportation?
8. How many days do you walk or cycle for at least 10 minutes continuously in a typical week? (It refers to the total time spent on commuting to work, shopping and attending parties, etc., but do not include walking or cycling specifically for physical exercise); What is the average cumulative commuting time you spend on walking or cycling at least 10 minutes continuously in a typical day?
9. What is the labor intensity of your daily house chores? [How many days in a typical week do you do high-intensity house chores (e.g. manual load handling or lifting, digging in the yard, etc.) lasting for more than 10 minutes? What is the average cumulative time you spend on doing such high-intensity house chores lasting for more than 10 minutes in a typical day? How many days in a typical week do you do moderate-intensity house chores (e.g. handling or lifting light objects, wiping the window, mopping the floor, cleaning the room, etc.) lasting for more than 10 minutes? What is the average cumulative time you spend on doing such moderate-intensity house chores lasting for more than 10 minutes in a typical day?]
10. What leisure-time activities do you usually do? (Choose 3 activities you most frequently do in descending order of time spent)

11. What is your exercise frequency?
12. What is your exercise duration each time in most cases?
13. In most cases, how do you feel physically during exercising?
14. What are your actual conditions when you do physical exercises each week? (How many days in a typical week do you do high-intensity physical exercises lasting for more than 10 minutes with significantly increased breathing, heart rate and sweating? How many times per day on average? How many minutes each time on average? How many days in a typical week do you do moderate-intensity physical exercises lasting for more than 10 minutes with slightly increased breathing, heart rate and slight sweating? How many times per day on average? How many minutes each time on average?)
15. How long have you kept on exercising as per the exercise frequency, duration and intensity chosen in Questions C11~C14?
16. How many days in a week do you usually do strength exercises (including bodyweight training such as push-ups, sit-ups, pull-ups, and squats; or equipment workout such as using dumbbells and elastic bands)?

2. Study Indicators

The study indicators were as follows:

Table 1-1 Study Indicators in 2020 Physical Fitness Study of Macao Residents

Type	Study indicators	Young Children	Children and adolescents (students)				Adults		Seniors
		Aged 3-6	Aged 6-12	Aged 13-18	Aged 19-22	Aged 20-39	Aged 40-59	Aged 60-79	
Anthropometric measurements	Height	●	●	●	●	●	●	●	
	Sitting height	●	●	●	●	●	●	●	
	Weight	●	●	●	●	●	●	●	
	Chest circumference	●	●	●	●	●	●	●	
	Waist circumference	●	●	●	●	●	●	●	
	Hip circumference	●	●	●	●	●	●	●	
	Body fat percentage	●	●	●	●	●	●	●	
	Shoulder width	●	●	●	●	●	●	●	
	Pelvis width	●	●	●	●	●	●	●	
	Foot length	●	●	●	●	●	●	●	
Physiological function	Resting pulse (heart rate)	●	●	●	●	●	●	●	
	Blood pressure		●	●	●	●	●	●	
	Vital capacity		●	●	●	●	●	●	
	Step test					●	●		
	Submaximal bicycle ergometer exercise test (optional)					●	●		
	2-minute high-knee running in place							●	
Physical fitness	10m shuttle run	●							
	50m run		●	●	●				
	50m × 8 shuttle run		●						
	800m run (female)			●	●				
	1,000m run (male)			●	●				
	Standing long jump	●	●	●	●				
	Walking on balance beam	●							
	Successive jumps with both feet	●							
	Inclined pull-ups (male)		●						
	Pull-ups (male)			●	●				
	Vertical jump		●	●	●	●			
	Grip strength		●	●	●	●	●	●	
	Back strength		●	●	●	●			
	Tennis ball distance throw	●							
	Sit and reach	●	●	●	●	●	●	●	
	One foot stands with eyes closed		●	●	●	●	●	●	
	Choice reaction time		●	●	●	●	●	●	
	Push-ups (male)					●			
One-minute sit-ups (female)		●	●	●	●				
30-second chair stand							●		
Health	Dental caries	●	●	●					
	Vision		●	●	●				
	Color vision		●	●	●				

Note: “●” represents that the indicator was measured in that age group.

(IV) Testing Apparatus

Jiamin II physical testing apparatus produced by Beijing Xindong Huateng Sports Facilities Co., Ltd. was used in this study. Specific models were as follows:

Table 1-2 Testing apparatus

No.	Products / Models	No.	Products / Models
1	(Adults) Stadiometer	11	(Children) Stadiometer
2	RCS-160 electronic digital scale	12	(Children) Electronic sit-and-reach measuring apparatus
3	FCS-1000 digital electronic spirometer	13	Electronic push-up counter
4	TJY-I digital heart rate monitor, stopwatch (stand-by)	14	Electronic sit-up counter
5	WCS-1000 digital grip dynamometer	15	Balance beam
6	Digital back dynamometer	16	Soft pack
7	Digital sit-and-reach measuring apparatus	17	Electronic standing long jump mat
8	Vertical jump test mat	18	Body composition monitor
9	FYS-I electronic reaction time measuring apparatus	19	Cardiopulmonary function monitor (ergometer)
10	DJZL-I electronic balance monitor		

Other apparatus :

Anthropometric measuring tape, sphygmomanometer, visual chart (eye chart illuminance was about 500 lux), color vision examination chart (People Health Publishing House, edited by Wang Kechang, 2nd Edition in 2004), tennis balls, stopwatches, starting flags and whistles, horizontal bars.

(V) Testing Methods

Testing methods included two parts: questionnaire and physique indicator testing (**Refer to Appendix 2 and Appendix 3 in Part IV**).

(VI) Scheduling

To guarantee the smooth operation of this study, Macao Sports Bureau has initiated various preparatory works with China Institute of Sport Sciences since 2019. In line with the actual situation of Macao, the 2020 Physical Fitness Study was set into three phases which included the preparatory phase in 2019, the testing phase in the second half year of 2020 due to the COVID-19 pandemic, and the result analysis phase in 2021 to 2022.

Table 1-3 Procedures of 2020 Physical Fitness Study of Macao Residents

Phases	Time	Work Contents
Preparatory phase	June to September, 2019	1. Worked out study scheme
		2. Developed work manual
		3. Purchased testing apparatus
	October to December, 2019	1. Trained recruits on essential skills
		2. Compiled work cards
		3. Developed entry software
Testing phase	January to December, 2020 (Testing was postponed in January 2020 due to COVID-19 pandemic, later resumed in July. Tasks 3~5 were therefore conducted during the period from July 2020 to May 2021)	4. Determined sampling units and numbers
		1. Examined recruits on skills
		2. Verified sampling units
		3. Checked testing quality
		4. Performed data entry
Data analysis phase	June 2021 to May 2022	5. Checked data entry
		1. Calculated statistics
		2. Input new data into the Macao residents physical fitness database
		3. Composed study report (in Chinese)
		4. Composed survey report for students (by three school age groups) (in Chinese)
		5. Composed fitness literacy survey report for young children, children and adolescents, adults and seniors

III. Organization and Implementation

(I) Work Preparation

1. Establishment of Organizational Network and Leadership

The physical fitness study is a large-scale social survey activity. To ensure the smooth implementation of the study, the Sports Bureau of Macao SAR has led and established a leadership group in collaboration with other relevant departments. Besides, an organizational network for physical fitness study comprising a Physical Fitness Monitoring Centre for Macao Residents and study sites was established to ensure the successful completion of the study.

Based on the platform established in 2015, the 2020 organizational network is comprised of the Physical Fitness Monitoring Centre for Macao Residents based in the Sports Medicine Centre of Macao Sports Bureau and study sites. The study sites were set at randomly-selected kindergartens, schools, work units and senior agencies. The respective responsibilities and tasks were as follows:

(1) Responsibilities of the leading group: to coordinate with relevant departments of the Macao SAR Government; to lead, organize and formulate implementation scheme; and to make important decisions during the physical fitness study of Macao residents.

(2) Tasks of the Physical Fitness Monitoring Centre for Macao Residents: to coordinate with China Institute of Sport Science to prepare the scheme and detailed procedures for the 2020 Physical Fitness Study of Macao Residents; confirmed testing apparatus necessary for the 2020 study; prepared data registration manual, work

manual and data entry software; trained monitoring staff and examiners and checkers; established study teams; organized and coordinated samples; to inspect, collate and calculate the study's data; and to study, analyze and complete the Scientific Fitness Literacy Report and Physical Fitness Report of Macao Residents.

Research group and study teams were established under the Physical Fitness Monitoring Centre for Macao Residents. The research group includes technicians from China Institute of Sport Science and Sports Medicine Centre of Macao Sports Bureau.

(3) Functions of study sites: to coordinate with the Physical Fitness Monitoring Centre in sampling and testing, including the organization of subjects, implementation of study scheme and the organization and management of study sites.

2. Revision of 2020 Physical Fitness Study Scheme of Macao Residents

Using the 2015 physical fitness study as basis, the Macao Sports Bureau together with China Institute of Sport Science has continued to survey on the exercise behavior of subjects and the Scientific Fitness Literacy Questionnaire was added to the survey. To ensure the continuity and comparability of the physical fitness indicators, new indicators including body fat percentage, submaximal bicycle ergometer exercise test, 2-minute high-knee running in place and 30-second chair stand were added in addition to the regular study indicators. Furthermore, the senior subjects were extended from aged 60-69 to aged 60-79 in order to track the health of a wider range of the population.

(1) Determination of Sample Size and Establishment of Study Sites

The Physical Fitness Monitoring Centre for Macao Residents is responsible for determining the number of subjects and study sites of this study. In order to ensure the scientificity, representation and comparability with past data of such large-scale studies at a society level, the sample size and sampling methods remained consistent to that of the 2015 physical fitness study.

Slight changes in study sites were mainly as follows: 1) for subjects aged 20 to 59 (adults), 7 study sites (Tai Fung Bank Limited, Future Bright Group, Caltex Oil (Macao) Ltd., Macao Gaming Industry Labourers Association, Sacred Heart Canossian College, Associação dos Escriturários, Macao Sports Press Association) were cancelled, and 3 new study sites [No.4341- Wynn Resorts (Macao), No.4342- Macao Fisherman's Wharf, No.4343- Transport Bureau) were selected; 2) for the subjects aged 60 to 79 (seniors), 6 study sites (Centro de Dia da Ilha Verde, Service centers of Macao Federation of Trade Unions, Centro de Convívio da Associação de Mútuo Auxílio dos Moradores do Sam Pá Mun, Centro de Convívio "Missão Luterana de Hong Kong e Macau/Centro de Terceira Idade Yan Kei", Centro de Cuidados Especiais Longevidade (Serviço de Apoio Domiciliário), Centro de Lazer e Recreação das Associações dos Moradores da Zona Sul de Macau) were cancelled, and 4 new study sites (No.4371- Centro das Idosas of the Women's Association of Macau, No.4372- Centro de Dia "Chong Pak Chi Ká", No.4373- Casa dos "Pinheiros" da Taipa, No.4374- Centro Diurno Prazer para Idosos of the Women's Association of Macau) were selected. **Refer to Appendix 4 to Part IV.**

(2) Revision of Indicators and Determination of Testing Apparatus

In consideration of the changing physical exercise pattern of Macao residents, and the continuity of the study, the Physical Fitness Monitoring Centre for Macao Residents together with China Institute of Sport Science have added The Scientific Fitness Literacy Questionnaire using the work of the 2015 physical fitness study as a basis. The survey mainly focused on fitness knowledge, fitness attitude, fitness skills and formation of fitness habits. The influencing factors of fitness behavior were also investigated, such as home environment, community environment, school environment, and personal societal level.

Testing apparatus are important carriers in obtaining the physical fitness study data. Since the physical fitness study is a scientific research that emphasized scientific and continuity, the consistency of the testing apparatus should be guaranteed in order to better explore the changing patterns of the public's physical fitness. Therefore, the 2020 physical fitness study adopted compatible testing apparatus (Beijing Xindong Huateng Sports Facilities Co., Ltd. - physical testing facilities of Jianmin-II) used in 2015.

3. Establishment of Study Teams

To ensure quality of the study, the Macao Sports Bureau has organized three study teams where the examiners were trained by Macao Sports Bureau and China Institute of Sport Science. The examiners must be trained, passed the examination and issued the 2020 Physical Fitness Study Trained Examiner Certificate before participating in the 2020 Physical Fitness Study of Macao Residents. Each study team should have their members filled out the registration form (Table 1-4).

Table 1-4 “2020 Physical Fitness Study of Macao Residents” study team member registration form

Study team: _____

Name	Gender	Age	Work Unit	Academic Background	Major	Study Indicators/ Work Contents	Remark

Study teams were divided into three parts based on the “three-fixing principle”, namely, study indicator, apparatus, and study examiner. Detailed requirements and division of work are as follows:

(1) Every study team was divided into five professional groups, namely: the groups of questionnaire, anthropometric measurements, physiological function measurements, physical fitness measurements and health examination.

(2) Every team consisted of one team leader and at least 25 team members. Notably, the team should have at least four females, three questionnaire investigators, two in charge of checking data and one medical professional.

(3) Tasks: The team leader was in charge of organizing, coordinating and providing technical supervision to the team to ensure quality of the study. The professional groups were responsible for completing the tests. Indicators such as weight, circumference and body fat percentage were tested by team members of the same gender. The checking team was in charge of quality assurance at the study site and the inspecting, sorting and filing of the data

manuals. The medical personnel were in charge of all medical services at the study site and timely handling of issues in case of emergency.

4. Preparation of Testing Apparatus

According to the sample size of the study, the Macao Sports Bureau has supplemented and maintained the testing apparatus of Jianmin-II produced by Beijing Xindong Huateng Sports Facilities Co., Ltd, and produced 12,000 copies of “Data Registration Manual of 2020 Physical Fitness Study of Macao SAR Residents” and 400 copies of work manuals. Souvenirs were also given to subjects to enhance participation enthusiasm.

(II) Technical Training

Before the study, team members were trained by Macao Sports Bureau and China Institute of Sport Science. In the second half of 2019, Macao Sports Bureau was responsible for the organization of members and timeline of the study, whereas China Institute of Sport Science was responsible for compiling training handbook as well as teaching theories and technical skills training.

The whole training included seminars, technical operation and Q&A sessions. Training lessons mainly focused on the detailed explanation of the work scheme, contents of the questionnaires and fill-out methods, physical study procedures, measuring methods of physical indicators and quality control” etc. There was an “on-site operational examination” at the end of the training where examiners, were required to pass the examination and received a 2020 Physical Fitness Study trained examiner certificate before participating in the study.

(III) Data Acquisition

The opening ceremony of the 2020 Physical Fitness Study of Macao Residents was held on January 10, 2020. Pilot data acquisition was performed from January 5 to 8. Official on-site data acquisition started on January 10 and was hold-off from January 23 due to COVID-19 pandemic. Data acquisition was resumed on July 1 when the epidemic was eased off, and was completed in November 2020. Three study teams were established to collect data for the study. During the on-site data acquisition, the study teams conducted the tests in strict accordance with the physical fitness study procedures and methods. The study teams followed precise standards to implement the tests, calibrated the apparatus and reassessed data to ensure validity of the scientific data.

(IV) Data Summarization

In order to guarantee the quality of data summarization, China Institute of Sport Science and Macao Sports Bureau have formulated “data verification and entry checking standards”, “data cleaning and checking procedures”, “data entry software validations for 2020 Physical Fitness Study of Macao Residents” and “logic checking of data”.

From early March to late June 2021, data verification, data entry and entry result checking were completed. All data registration manuals were 100% reviewed. The reviewed contents include clarity and completion of the classification codes, any overlooked problems and logic errors, and any missing indicators. The review process has laid a solid foundation for improving data entry efficiency. Double data entry method and “a one-man approach” were adopted for data entry. Each person was responsible for data entry of one sampling unit and should complete the entry promptly.

By July 2021, a total of 11,414 valid data registration manuals were completed after going through a two-stage quality control management system, namely, an on-site data acquisition and data summarization by the Physical Fitness Monitoring Centre for Macao Residents.

IV. Quality Control

The quality control system ensured scientific and valid study data. The 2020 physical fitness study quality control process was divided into four phases, namely, work preparation, data acquisition, data summarization and data cleaning using a two-stage management system (study sites – study team – Physical Fitness Monitoring Centre for Macao Residents). Re-examination card, re-examination errors analysis form, apparatus calibration and maintenance form, and double-checking procedure were utilized during the whole quality control process.

(I) Quality Control of Pre-study Preparation

The 2020 Physical Fitness Study of Macao Residents was a well designed and organized system project, the active and prudent preparations before the study were the foundation of success. Thus, quality control was performed strictly for each and every routine before data acquisition.

1. Establishment of Organizational Network and Leadership

The organizational network system established in 2015 has continued to be adopted in 2020. The network was led by Macao Sports Bureau to coordinate relevant departments into leading teams. The technical network is mainly composed of the Physical Fitness Monitoring Centre for Macao Residents, which is based in the Sports Medicine Centre under Macao Sports Bureau, randomly-selected kindergartens, schools, work units and senior agencies. Whereas China Institute of Sport Science provided technical support.

2. Revision of 2020 Physical Fitness Study Scheme

Based on continuity and comparability of study indicators, the subjects were extended to seniors aged 70-79. Also, to better explore the in-depth issues on sports of Macao residents, the scientific fitness literacy of residents was added to the survey.

3. Establishment of Study Teams

In order to guarantee quality of the study, China Institute of Sport Science provided detailed guidance for the establishment of the study teams. Three study teams were established for the study. The members were mainly students from the University of Macau and students of the physical education program from Macao Polytechnic Institute. These examiners with good health and manners laid a solid foundation for the successful completion of this study.

4. Preparation of Testing Apparatus

Based on continuity and comparability of study indicators, Macao Sports Bureau has decided to continue using the testing apparatus (Beijing Xindong Huateng Sports Facilities Co., Ltd. - physical testing apparatus of Jianmin-II) used in the 2015 physical fitness study. Besides, “Data Registration Manual of 2020 Physical Fitness Study of Macao Residents” and “Work Manual of 2020 Physical Fitness Study of Macao Residents” were developed according to the sample size. Souvenirs were distributed to the subjects to enhance their enthusiasm.

5. Technical Training

The technical training of the 2020 Physical Fitness Study of Macao Residents was performed on-site, and nearly 200 recruits were trained.

Key points on quality control and on-site data acquisition of the study were integrated into the technical training course. Theoretical knowledge and practical operation were conducted interactively to ensure examiners kept abreast of training knowledge. Finally, “on-site operational examination” was performed. The examiners had

to pass the examination and obtained the 2020 Physical Fitness Study of Macao Residents Trained Examiner certificate before participating in the study.

Training material is the “Work Manual of 2020 Physical Fitness Study of Macao Residents”, prepared by China Institute of Sport Science and Macao Sports Bureau.

(II) Quality Control of Data Acquisition

During the whole data acquisition process, quality control was performed before, during and after data acquisition.

1. Preparation before Data Acquisition

Before data acquisition, apparatus and study sites should be prepared.

(1) Determination of Study Procedures

The study procedures are one major factor that affects study quality. Therefore, all study teams had to follow the study procedures strictly.

Study procedures were carried out as follows:

“**Questionnaire** → **Physiological function (and health)** → **Anthropometric measurements** → **Physical fitness**” (see Figure 1-1)

The study procedures on health, anthropometric measurements and physical fitness could be carried out interchangeably, but the examination of heart rate (pulse) must be performed first.

In principle, each study team should not be testing over 200 subjects per working day.

The study team members should collect the data registration manuals and have checked the contents at the same time.

(2) Preparation of Apparatus

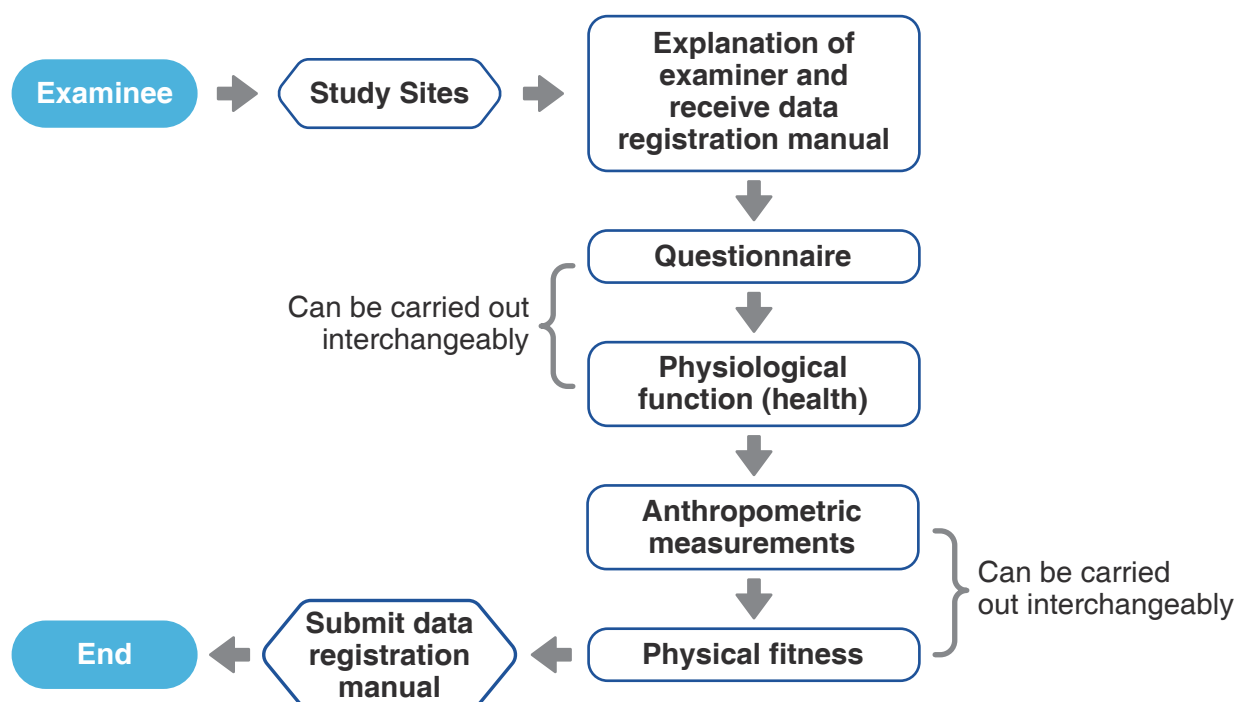

Figure 1-1 Workflow of the study process

- ① The testing apparatus used in the 2020 physical fitness study are the same as those used in the national physical fitness study of Mainland China.
- ② Before the study, apparatus should be prepared, installed, calibrated and tested.
- ③ A sufficient number of consumables (e.g. disposable mouthpieces and alcohol) should be prepared in advance.

Refer to (IV) **Testing Apparatus in II. Subjects and Methods of Part I** for apparatus required in this study.

(3) Calibration of Apparatus

① Stadiometer

Study team members check the stadiometer by using a standard 150cm steel ruler. First, place the “0” point of the steel ruler at the bottom of the stadiometer and place the steel ruler against the stadiometer. The slider of the stadiometer is then slid down to the top of the steel ruler. The requirement is met if the value between the stadiometer and the reading of the steel ruler is less than 0.1cm.

② Electronic Digital Scale

Study team members switch on the scale and allow the scale to enter normal work mode. A 10kg, 20kg and 30kg standardized weight or equivalent objects were put onto the scale respectively for calibration. If the value of the scale is the same as the weight, the apparatus is precise. Afterwards, a 100g standardized weight is added to the scale. If the figure shown on the screen is increased by 0.1kg, the sensitivity of the scale has met the requirement.

③ Measuring Tape

The measuring tape is compared with a standardized steel ruler. If the error per meter is less than 0.2cm, the measuring tape has met the requirement.

④ Bare L-square

The two angles should meet at the “0” mark. A standardized steel ruler is used to check the mark and the error should be less than 0.1cm.

⑤ Electronic Spirometer

Study team members turn on the spirometer and allow it to enter work mode. Then, the spirometer is checked with a 2000ml gas-measuring tube. The plunger of the measuring tube is pulled to the maximum mark, and connected with the spirometer. Gas is then slowly pushed into the spirometer until empty (Figure 1-2). If the value of the spirometer is within ± 40 ml range of 2000ml (between 1960ml and 2040ml), the spirometer has met the requirement.

⑥ Stopwatch

The stopwatch is checked according to Beijing Time. If the stopwatch value is within 0.2 second per minute, the stopwatch is precise and has met the requirement.



Figure 1-2 Calibration of electronic spirometer

⑦ Sphygmomanometer

The rubber ball, rubber hose and rotary knobs of gas valve are checked to ensure normal operation.

(4) Site Preparation

Before testing, study teams should arrange study sites in advance. Indoor study sites could be composed of several rooms and the total area should be no less than 150m². Indoor study site should have flat ground, be large and bright enough to facilitate arrangement of testing apparatus as well as the control of the flows of participants. Function indicators should be tested in a quiet venue (or room). Weight, circumference and body fat percentage indicators should be separately measured according to gender.

Students need outdoor site for testing, preferably 400m or 200m standard ground track field.

2. Quality Control during Data Acquisition

Quality control during data acquisition is to manage examiners, examinees, testing methods and results in an accurate and scientific manner.

(1) Requirement for Examiners

- Enter the study site 30 minutes in advance to do preparation work, such as checking and calibrating the apparatus.
- Explain the test requirements to the examinee before testing.
- Timely review the results in case a re-test is needed.
- Strictly follow all requirements of the study and should not alter the contents, methods or quality requirements of the study.

(2) Requirement for Examinees

- Avoid strenuous exercise and heavy labor work 12 hours before the test.
- Keep quiet when at the study site.
- Complete each test at one's best according to requirements.
- Dress code: sportswear and sports shoes. During anthropometric measuring, male examinees should wear shorts and tank top or short-sleeve shirt with shorts for the female examinees.
- Stretch and warm up before and after the examination to prevent injury.
- In principle, every examinee should complete the entire examination in one day. Even under special circumstances, all tests should be completed within one week.

(3) Verifying Data Entry

Each study team had appointed two professional members to be responsible for checking the results of the examination. The checkers should be diligent and familiar with the project.

● Primary On-site Examination

- ① After the examination, checkers had to check the classification codes and if the recording of questionnaire and indicators in the data registration manuals were correctly and clearly filled out. If any noncompliance record was found, checkers had to point out immediately to the examiner and correct it on-site. During the whole study process, 1,095 pieces of missing, wrong or suspicious data were found. Supplement testing or re-examination was carried out to make sure the value is complete, correct and reliable.

- ② All study results had to be checked according to the Re-examination Reference Table (Tables 1-5 to 1-10). 213 data registration manuals were found to have anthropometric and physiological function results that are over the reference range. If the results were not marked with “re-examined” or reasons such as illnesses or disabilities, they were considered suspicious data and would be re-examined by the original examiner on-site. In the end, 96 pieces of incorrect data were corrected.
- ③ Physical fitness indicators in 72 data registration manuals were beyond the Re-examination Reference Table references and were checked according to other relevant indicators to rule out doubts and prevent incorrect recordings. Six undetermined data items were rejected.

Table 1-5 “Re-examination Reference Table” for young children

Indicator	Age 3	Age 4	Age 5	Age 6
Male				
Resting heart rate (bpm)	70 ~ 120	70 ~ 120	70 ~ 120	70 ~ 120
Height (cm)	85 ~ 125	90 ~ 135	95 ~ 140	108 ~ 145
Sitting height (cm)	45 ~ 70	50 ~ 75	53 ~ 80	55 ~ 85
Weight (kg)	10 ~ 25	11 ~ 27	13 ~ 34	15 ~ 40
Chest circumference (cm)	48 ~ 60	49 ~ 65	51 ~ 75	52 ~ 80
Sit and reach (cm)	-5 ~ 20	-5 ~ 20	-5 ~ 20	-5 ~ 20
10m shuttle run (sec)	7.0 ~ 20.0	6.0 ~ 18.0	6.0 ~ 15.0	5.0 ~ 12.0
Standing long jump (cm)	20 ~ 100	30 ~ 130	40 ~ 150	50 ~ 160
Tennis ball distance throw (m)	1.0 ~ 8.0	1.0 ~ 10.0	2.0 ~ 13.0	2.5 ~ 16.0
Successive jumps with both feet (sec)	5.0 ~ 38.0	4.0 ~ 20.0	3.0 ~ 15.0	3.0 ~ 13.0
Walking on Balance Beam (sec)	5.0 ~ 80.0	3.0 ~ 70.0	3.0 ~ 50.0	2.0 ~ 30.0
Female				
Resting heart rate (bpm)	72 ~ 130	70 ~ 130	70 ~ 120	70 ~ 120
Height (cm)	85 ~ 120	90 ~ 130	95 ~ 140	108 ~ 145
Sitting height (cm)	45 ~ 70	50 ~ 79	53 ~ 80	55 ~ 85
Weight (kg)	10 ~ 25	12 ~ 28	13 ~ 35	15 ~ 40
Chest circumference (cm)	40 ~ 65	42 ~ 70	45 ~ 75	48 ~ 80
Sit and reach (cm)	-5 ~ 20	-5 ~ 21	-5 ~ 22	-5 ~ 22
10m shuttle run (sec)	7.0 ~ 20.0	6.0 ~ 18.0	6.0 ~ 15.0	5.0 ~ 12.0
Standing long jump (cm)	20 ~ 100	30 ~ 120	40 ~ 130	50 ~ 140
Tennis ball distance throw (m)	1.0 ~ 6.0	2.0 ~ 10.0	2.0 ~ 12.0	2.0 ~ 16.0
Successive jumps with both feet (sec)	5.0 ~ 35.0	5.0 ~ 20.0	4.0 ~ 15.0	4.0 ~ 13.0
Walking on Balance Beam (sec)	5.0 ~ 100.0	4.0 ~ 70.0	3.0 ~ 50.0	2.0 ~ 30.0

Table 1-6 “Re-examination Reference Table” of physical fitness indicator for children and adolescents (students)

Indicator Age (yr)	50 meters (sec)	Inclined pull-ups/ Pull-ups (times)	Sit-ups (times/min)	Sit and reach (cm)	Standing long jump (cm)	50 meters × 8 shuttle run (sec)	800 meters (sec)	1,000 meters (sec)
Male								
7 - 9	14.0~7.7	0~52		-10~24	70~200	160~80		
10 - 12	12.0~7.1	0~60		-12~26	80~230	140~80		
13 - 15	11.0~7.0	0~35		-15~28	90~270	~		360~170
16 - 18	10.5~6.5	0~35		-12~38	100~290	~		330~160
19 - 22	10.0~6.3	0~40		-15~38	110~320	~		330~150
Female								
7 - 9	15.0~8.0		4~55	-5~27	65~190	170~85		
10 - 12	13.0~7.3		6~60	-6~29	75~220	150~80		
13 - 15	12.0~6.2		8~60	-10~32	85~250	~	330~150	
16 - 18	12.0~6.9		2~60	-10~34	95~280	~	330~140	
19 - 22	12.0~7.0		2~60	-10~34	100~300	~	330~140	

Table 1-7 “Re-examination Reference Table” of pulse and blood pressure for children and adolescents (students)

Age (yr)	Male			Female		
	Pulse (times/min)	Systolic Blood Pressure (mmHg)	Diastolic Blood Pressure (mmHg)	Pulse (times/min)	Systolic Blood Pressure (mmHg)	Diastolic Blood Pressure (mmHg)
7	72-104	86-112	50-80	72-106	85-112	50-81
8	72-102	87-114	51-81	72-104	86-112	50-81
9	70-100	88-118	51-82	72-104	88-119	51-82
10	68-100	90-120	52-82	72-102	89-121	51-82
11	68-100	88-121	52-82	70-100	90-122	53-82
12	68-98	90-122	54-82	70-100	91-125	56-85
13	66-98	91-126	55-82	70-100	91-126	57-84
14	66-96	92-130	58-86	68-98	91-128	58-85
15	64-96	96-134	60-69	68-98	94-129	57-86
16	64-96	99-137	60-90	66-98	95-130	60-87
17	62-96	100-140	61-91	66-98	95-131	60-87
18	62-96	100-140	61-91	66-96	92-130	60-89
19~22	60-92	100-140	61-91	62-94	92-134	60-90

Table 1-8 “Re-examination Reference Table” of vital capacity (ml) for children and adolescents (students) (ml)

Age (yr)	Male	Female
7	560-2200	500-2000
8	650-2500	600-2300
9	800-2700	700-2500
10	900-2900	770-2800
11	970-3200	850-3000
12	1000-3600	960-3300
13	1100-4300	1100-3700
14	1200-4900	1200-3800
15	1600-5300	1400-3900
16	2000-5600	1500-4000
17	2100-5800	1500-4100
18	2200-5900	1500-4200
19~22	2400-6000	1700-4200

Table 1-9 “Re-examination Reference Table” of anthropometric indicator for children and adolescents (students)

Age (yr)	Male						Female					
	Height (cm)	Weight (kg)	Chest circumference (cm)	Shoulder width (cm)	Pelvis width (cm)	Body fat percentage (%)	Height (cm)	Weight (kg)	Chest circumference (cm)	Shoulder width (cm)	Pelvis width (cm)	Body fat percentage (%)
7	105-137	13-30	48-67	22-30	16-23	5-50	105-136	12-29	47-65	21-30	16-23	5-50
8	109-142	14-33	49-69	22-31	16-24	5-50	108-142	13-32	47-68	22-31	16-24	5-50
9	113-148	14-37	50-72	23-32	17-24	5-50	113-148	14-36	48-70	23-32	17-24	5-50
10	118-153	15-41	51-57	24-33	17-25	5-50	116-156	15-42	49-74	24-34	17-25	5-50
11	121-160	16-46	52-78	25-35	18-26	5-50	121-164	15-48	50-79	25-36	18-26	5-50
12	123-167	17-52	53-81	25-36	18-27	5-50	126-168	17-54	52-83	26-37	18-27	5-50
13	129-178	19-61	56-87	26-39	19-29	5-50	135-171	23-59	57-87	27-38	19-29	5-50
14	136-183	23-67	59-91	27-41	19-31	5-50	138-172	26-62	60-88	29-39	19-31	5-50
15	144-185	29-71	63-94	29-42	21-31	5-50	140-173	29-64	62-89	29-39	21-31	5-50
16	150-185	34-73	67-95	31-43	22-31	5-50	142-174	31-65	63-90	30-39	22-31	5-50
17	151-187	36-74	70-96	32-43	22-32	5-50	142-174	32-66	64-91	30-39	22-32	5-50
18	152-187	38-75	71-97	32-43	22-32	5-50	142-174	32-67	65-91	30-39	22-32	5-50
19~22	153-187	40-76	73-98	33-44	22-32	5-50	142-175	33-67	65-92	30-40	22-32	5-50

Table 1-10 “Re-examination Reference Table” for adults and seniors

Indicator	Male		Female	
	≤ Age 39	≥ Age 40	≤ Age 39	≥ Age 40
Resting heart rate (bpm)	50 ~ 120	50 ~ 120	50 ~ 120	50 ~ 120
Systolic Blood Pressure (mmHg)	90 ~ 180	90 ~ 180	80 ~ 180	80 ~ 180
Diastolic Blood Pressure (mmHg)	50 ~ 100	60 ~ 100	50 ~ 100	55 ~ 100
Height (cm)	140 ~ 200	140 ~ 200	140 ~ 190	140 ~ 190
Weight (kg)	35 ~ 110	35 ~ 110	35 ~ 90	35 ~ 95
Chest circumference (cm)	60 ~ 120	60 ~ 120	60 ~ 120	60 ~ 120
Waist circumference (cm)	60 ~ 120	63 ~ 120	56 ~ 120	59 ~ 120
Hip circumference (cm)	70 ~ 120	70 ~ 120	70 ~ 120	75 ~ 120
Body fat percentage (%)	5 ~ 50	5 ~ 50	5 ~ 50	5 ~ 50
Vital capacity (ml)	1000 ~ 7000	1000 ~ 6000	800 ~ 6000	800 ~ 5000
One-minute heart rate (times)	30 ~ 90	30 ~ 90	30 ~ 90	30 ~ 90
Two-minute heart rate (times)	30 ~ 80	30 ~ 80	30 ~ 80	30 ~ 80
Three-minute heart rate (times)	30 ~ 70	30 ~ 70	30 ~ 70	30 ~ 70
Exercising time (sec)	60 ~ 180	60 ~ 180	60 ~ 180	60 ~ 180
Grip strength (kg)	20 ~ 80	20 ~ 80	15 ~ 60	15 ~ 60
Sit and reach (cm)	-15 ~ 26	-15 ~ 26	-10 ~ 30	-11 ~ 30
Vertical jump (cm)	15 ~ 75		10 ~ 70	
Back strength (kg)	30 ~ 220		20 ~ 150	
Push-ups (times)	0 ~ 50			
One minute sit-ups (times/min)			0 ~ 60	
One foot stands with eyes closed (sec)	2 ~ 150	2 ~ 150	2 ~ 150	2 ~ 150
Choice reaction time (sec)	0.220 ~ 0.90	0.30 ~ 2.00	0.220 ~ 0.90	0.30 ~ 2.00
Maximal oxygen consumption [ml/(kg/min)]	20 ~ 60	20 ~ 55		

● Random re-examination check

① Method of re-examination

Checkers randomly picked 5% of total examinees each day to re-examine the anthropometric indicators and checked for errors. Detailed procedures were as follows:

- ◆ The data registration manual was collected and a re-examination card (Table 1-11) was issued. The original examiner would re-examine all the anthropometric indicators following the original examination procedures and methods.
- ◆ After re-examination, the examinee would submit the re-examination card to the checker, who would carefully fill in the original results from the data registration manual into the re-examination card, and return the original data registration manual to the examinee to complete the remaining indicators.
- ◆ Checkers and the team leader of the study team would calculate errors together. Each indicator would have the re-examined value deducted from the original value to give the error of differences. The sum of errors that exceed the acceptable reference range was recorded (**See Acceptable range of error for anthropometric indicators**).
- ◆ Checkers should calculate the occurrence rate of re-examination error exceeding the acceptable range once every three days, and record in the table of re-examination errors (Table 1-12). Error occurrence rate is calculated as per the following formula:

$$P = \frac{\sum n}{AN}$$

In the formula, $\sum n$ means the total frequency of re-examination error exceeding the acceptable range. “A” means the total number of anthropometric indicators in each re-examination card. “N” means the number of re-examination card (number of examinees who are picked randomly to be re-examined).

Table 1-11 Re-examination card

Name _____ Gender _____ Age _____ Work Unit _____

Categories of sample: please mark "√" on your respective category

Young children	Primary students	Secondary students	University students	Labor intensive adults	Non-labor intensive adults	Seniors

1. Examination Date _____ 2. Date of Birth _____

3. Parish _____ 4. Examination No. _____

Indicator	Original value	Re-examination value	Difference (Original - re-examination)	Beyond the acceptable error range (Y/N)
Height (cm)				
Sitting height (cm)				
Weight (kg)				
Chest circumference (cm)				
Waist circumference (cm)				
Hip circumference (cm)				
Shoulder width (cm)				
Pelvis width (cm)				
Foot length (cm)				
Total				

Table 1-12 Table of re-examination errors

Study team : _____

Date of examination	Total No. of examinees	No. of re-examinees	Error occurrence rate	Signature
Total				

② Standard of re-examination

◆ Day of examination

During the day of examination, if the error of certain anthropometric indicator was found to be beyond the acceptable range, the checkers should discuss with the examiners immediately to find out the reasons and suggested corrective actions. Examination methods should be amended promptly to meet the requirements and such indicator should be re-examined on all examinees.

◆ Within three days of examination

If the error occurrence rate was larger than 5% within three days of the examination, checkers should detect the reasons and find a solution immediately. Unqualified examiners had to be re-trained and passed the examination again before being able to return to their position. If the occurrence rate is larger than 10%, all data recorded would be invalid. The anthropometric indicators of all tested examinees had to be re-examined.

③ Acceptable range of error for anthropometric indicators

Height: $\pm 0.5\text{cm}$; Sitting height: $\pm 0.5\text{cm}$; Weight: $\pm 0.1\text{kg}$; Chest, waist and hip circumference: $\pm 1.0\text{cm}$; Shoulder, pelvis width: $\pm 0.5\text{cm}$; Foot length: $\pm 0.2\text{cm}$.

During the whole study process, the re-examination rate was 4.8% and error occurrence rate was 2.8%, which met the quality control standard.

(4) Calibration and Maintenance of Apparatus

The apparatus used for anthropometric measurement and physiological function had to be properly calibrated before the beginning of each testing. Any apparatus with tested values that exceeded the acceptable range should be calibrated, maintained or replaced promptly with the apparatus calibration and maintenance form filled out (Table 1-13).

Table 1-13 Apparatus calibration and maintenance form

Equipa de teste : _____

Calibration time	Name of apparatus	Error value	Solution	Signature

Throughout the whole study, apparatus calibration was performed 32 times. Two step-test apparatuses, two electronic balance monitors and one electronic reaction time measuring apparatus were maintained and replaced.

(III) Quality Control of Data Summarization

This phase refers to the quality control of the timeline from the data summarization process in the Physical Fitness Monitoring Centre for Macao Residents to the establishment of the original database. This period mainly includes the checking, verification, data entry and the verification of data entry and results of the data registration manuals.

1. Checking of Data Registration Manual

Upon completion of examinations, each study team had allocated members to organize, categorize and check the data registration manuals. Details were as follows:

- ◆ Ensure validity of the data registration manuals: If one classification code or three data items were invalid, this data registration manual would be regarded as invalid. Data registration manuals which could not be re-confirmed, re-done or re-examined should be removed.
- ◆ Fill out the Classification table for data registration manual (Table 1-14).

Table 1-14 2020 Classification table for data registration manual

Study team : _____

Subject : _____

Age group (years)	Male	Female	Sub-total	Remark
3	232	143	375	
4	194	129	323	
5	230	165	395	
6	13	7	20	
Sub-total	669	444	1113	
6	238	171	409	
7	238	172	410	
8	257	157	414	
9	188	160	348	
10	199	142	341	
11	180	151	331	
12	208	185	393	
13	200	155	355	
14	186	151	337	
15	169	152	321	
16	174	158	332	
17	184	200	384	
18	163	156	319	
19	127	117	244	
20	106	97	203	
21	58	63	121	
22	41	32	73	
Sub-total	2916	2419	5335	
20 ~ 24	169	196	365	
25 ~ 29	215	425	640	
30 ~ 34	213	462	675	
35 ~ 39	193	329	522	
Sub-total	790	1412	2202	
40 ~ 44	178	210	388	
45 ~ 49	167	266	433	
50 ~ 54	181	240	421	
55 ~ 59	185	263	448	
Sub-total	711	979	1690	
60 ~ 64	97	252	349	
65 ~ 69	81	217	298	
70 ~ 74	95	146	241	
75 ~ 79	85	101	186	
Sub-total	358	716	1074	
Total	5444	5970	11414	

2. Examination of Data Registration Manual

In order to guarantee accuracy and reliability of the study results, the Physical Fitness Monitoring Centre for Macao Residents had strictly verified data registration manuals and various analysis tables received from each study team.

Detailed verifying methods were as follows:

Firstly, the Centre checked whether the data registration manuals were grouped by categories, gender and age; and whether sample size of each age group has met the required quantity.

Secondly, the Centre randomly selected 5% (about 600 registration manuals) of all the data registration manuals for examination and verification according to the systematic sampling method.

Contents of verification: Firstly, check whether the classification codes were filled clearly and completely. Secondly, check whether any items were omitted or any logic errors. Lastly, check whether there were missing indicators left untested.

Verification standards and solutions: Classify and correct on the spot any data registration manuals with issues. If there were over 5% of unqualified registration manuals, all data registration manuals of the same team would be re-classified and re-checked. Logic reasoning or re-examination by the original study team could be done on individual data registration manuals with suspicious figures. If any suspicious figure could not be confirmed, the data registration manuals with such figure would be removed and not be entered into the database.

Verification results: Through examining the data registration manuals, logic contradictions was found to be the main issue including “age” and “years of residence in Macao”, “with or without diseases” and “types of diseases suffered”, as well as “descending heart rate in step test” for the tested indicators conducted. There were about 1,031 suspicious items in the end. Correction was carried out promptly on the spot by experts at the Physical Fitness Monitoring Centre for Macao Residents.

3. Data Entry

Data entry was done using the dual data input method and was matched automatically by the computer and completed by the Physical Fitness Monitoring Centre for Macao Residents. During the entire data entry work, a “One-man Responsibility system” was established where each staff member was responsible for the entry of data registration manuals of one sampling unit, and each questionnaire should be completed at once.

Entry result standard: The error occurrence rate of data entry had to be controlled to under 0.05%. If this rate exceeds 0.05%, the data entry work must be stopped, deleted and re-entered. The responsible entry clerk could not resume the position until he/she is re-qualified after training.

4. Checking of Entry Results

5% of all data registration manuals (about 570 manuals) were randomly selected for verification of entry results. The method used for random selection of registration manuals was as follows: the registration manuals entered by each entry clerk were considered as one sampling unit. According to the systematic sampling method, 56 registration manuals were taken from the young children group, 267 registration manuals were taken from the children and adolescents (students) group, 110 registration manuals were taken from adults group A, 84 registration manuals were taken from adults group B, and 53 registration manuals were taken from the seniors group. All selected questionnaires were manually checked. The scope of selection includes the entry results of each entry clerk and both genders of each age group.

The digital data was compared with the raw data of the data registration manuals to check for consistency. If the two values were inconsistent, the value in the database was modified based on the data registration

manuals. 40 data items were modified in the young children group, 58 data items were modified in the children and adolescents (students) group, 12 data items were modified in adults group A, 17 data items were modified in adults group B, and five data items were modified in the seniors group.

From January 10 to 31, 2021, checking for entry results was completed by the Physical Fitness Monitoring Centre for Macao Residents. The error rate of entry results was 0.024%, which reached the national quality standard of data entry. Entry errors were largely presented in “8”-“5”, “9”-“6”, and “entry of null value in wrong line”. The Centre’s experts have timely corrected about 97 characters from manual check error and logic test error.

5. Data Cleaning

Data cleaning is the last step in the calculation of database for data screening. The data were subject to comprehensive logic judgment of options, which was mainly through logic judgment of different indicators, different indicators with extreme values, screening of repeated data, deletion of repetitive samples by sex and age, and the logic judgment of answer options of sequential questions of each questionnaire.

(1) Logic Judgment Entries between Study Indicators

Logic judgment entries of study indicators adopted in this study were based on three classifications: age, height and weight. The age-group classification has six groups of males and females, which includes the the young children group (aged 3-6), primary students group (aged 6-12), children and adolescents group (aged 13-22), adults group A (aged 20-39), adults group B (aged 40-59) and seniors group(aged 60-79). Indicators used include height, weight, body mass index, chest circumference, waist circumference, hip circumference, 10m shuttle run, standing long jump, successive jumps with both feet, walking on balance beam, sit and reach, tennis ball distance throw, systolic blood pressure, diastolic blood pressure, vital capacity, standing long jump, 50m run, grip strength, vertical jump, back strength, and choice reaction time. The height classification includes weight, vital capacity, grip strength and standing long jump. The weight classification includes chest circumference, waist circumference, hip circumference, systolic blood pressure, diastolic blood pressure, standing long jump/vertical jump, back strength, sit and reach, one foot stands with eyes closed, choice reaction time, 50m run, grip strength/back strength and vertical jump.

(2) Logic Judgment Entries of Questionnaires

Logic judgment statements were compiled for logic judgment of all questionnaires.

For example: Young children group

▲Classification code

- ① Gender of young children: 1 or 2;
- ② After subtracting date of birth from test date, the age should be within 3-6 years;
- ③ Years of residence of young children in Macao shall be within the age range.

▲Questionnaire: answers that are beyond available options to specific questions.

▲The specific types of questions were as follows:

Personal Information of Young Children :

- ① Question 10: for young children with birth weight \geq 6kg, note that the value 99.9 is considered effective fill-in value.
- ② Question 11: for young children with birth length \geq 60cm, note that the value 99.9 is considered effective fill-in value.
- ③ Question 14: if “(2) None” is selected, proceed to Question 16.

Paternal Personal Information:

- ① The years of residence in Macao should be within the age range.
- ② Indicators of height and weight should be within the reasonable range of adults.

Fitness Literacy of Young Children:

- ① Question A2: Option 26 is exclusive.
- ② Question A3: The number of chosen options should be less than that of Question A2.

(3) Results of Data Cleaning

▲Study indicators:

- ① Screening results: 156 suspicious data from the young children group, 202 suspicious data from the children and adolescents (students) group, 287 suspicious data from adults group A, 196 suspicious data from adults group B, and 56 suspicious data from the seniors group.

- ② Data results manually checked, deleted and revised by experts:

Young children group: 15 anthropometric data items, 10 physiological function data items and 26 physical fitness data items were deleted.

Children and adolescents (students) group: 52 anthropometric data items, 26 physiological function data items and 22 physical fitness data items were deleted.

Adults group A: 14 anthropometric data items, 16 physiological function data items and 7 physical fitness data items were deleted.

Adults group B: 9 anthropometric data items, 12 physiological function data items and 5 physical fitness data items were deleted.

Seniors group: 6 anthropometric data item, 11 physiological function data items and 7 physical fitness data items were deleted.

▲Questionnaire indicators:

- ① 298 suspicious data from the young children group, 306 suspicious data from the children and adolescents (students) group, 462 suspicious data from adults group A, 398 suspicious data from adults group B, and 190 suspicious data from the seniors group.
- ② Errors included allocation of answer in the wrong coding box, and logic contradiction between age and years of residence in Macao.
- ③ Solution: for questions with multiple answer options, if the first and the second coding boxes were 0, and there was an answer in the third coding box, the third code should be rewritten in the first coding box.

In the end, 2,551 suspicious data items were voided (including 1,654 suspicious data items from the questionnaire). The numbers of valid samples in the database after data cleaning were 11,414.

6. Database Establishment

The establishment of an original database requires repeated screenings and review by researchers to ensure the validity and scientificity of the data registration manuals. Prior to establishing the database, the Physical Fitness Monitoring Centre for Macao Residents and China Institute of Sport Science have carefully carried out logic inventory work. Ultimately, 65 data items were voided and a total of 11,414 samples were included in the original database.

V. Statistical Analysis

(I) Grouping

1. Young children were classified according to gender and age (1 year difference between each age group), giving rise to eight groups in total.

2. Students aged 6 to 22 were classified according to gender and age (1 year difference between each age group), giving rise to 34 age groups. In addition, students were also subdivided into three groups: aged 6~12, 13~18 and 19~22, with six age sub-groups altogether.

3. Adults were classified into four categories according to age, gender, labor workers and non-labor workers. Each category is divided into groups of five years of age differences, giving rise to 32 groups in total.

4. Seniors were classified into two categories according to gender. Each category is divided into age groups of five years age differences, giving rise to eight groups in total.

5. Regional grouping: The seven parishes in Macao were divided into three areas: North (Nossa Senhora de Fátima), Central (Santo António and S.Lázaro) and South (S. Lourenço, Sé Catedral, Nossa Senhora do Carmo and São Francisco Xavier).

(II) Indicators

1. Indicators of Inquiry

① Young children: 57 items under seven categories including basic information (birth place, parish of residence, kindergarten attendance, etc.), birth and feeding patterns, living habits, occurrence of diseases, dental hygiene, and fitness literacy.

② Students: More than 40 items (over 70 items in the survey for students of grades 1~3 in particular) under seven categories including basic information (birth place, parish of residence, school attendance, etc.), living habits, Physical Education class at school, extracurricular physical exercises, occurrence of diseases, dental hygiene, and fitness literacy.

③ Adults: More than 40 items under six categories including basic information (labor intensity of daily work, birth place, parish of residence, education level, occupation, etc.), living habits, physical exercises, occurrence of diseases, fitness literacy, and understating of the physical fitness study.

④ Seniors: More than 40 indicators under six categories including basic information (labor intensity of daily work, birth place, parish of residence, education level, occupation before retirement, etc.), living habits, physical exercises, occurrence of diseases, fitness literacy, and understanding of the physical fitness study.

2. Study Indicators

① Anthropometric measurements: height, sitting height, weight, chest circumference, waist circumference, hip circumference, body fat percentage, shoulder width, pelvis width and foot length; a total of 10 items.

② Physiological functions: resting pulse (heart rate), blood pressure, vital capacity, step test (adults), submaximal bicycle ergometer exercise test (optional), 2-minute high-knee running in place (seniors); a total of 6 items.

③ Physical fitness indicators:

■ Young children

Aged 3~6: Six items including 10m shuttle run, standing long jump, walking on balance beam, successive

jumps with both feet, tennis ball distance throw, and sit and reach.

■ Children and adolescents

Aged 6~12: 11 items including 50m run, 50m x 8 shuttle run, standing long jump, inclined pull-ups (male), one-minute sit-ups (female), vertical jump, grip strength, back strength, sit and reach, one foot stands with eyes closed, and choice reaction time.

Aged 13~18: 11 items including 50m run, 800m run (female) or 1,000m run (male), standing long jump, pull-ups (male), one-minute sit-ups (female), vertical jump, grip strength, back strength, sit and reach, one foot stands with eyes closed, and choice reaction time.

Aged 19~22: 11 items including 50m run, 800m run (female) or 1,000m run (male), standing long jump, pull-ups (male), one-minute sit-ups (female), vertical jump, grip strength, back strength, sit and reach, one foot stands with eyes closed, and choice reaction time.

■ Adults

Aged 20~39: Eight items including vertical jumps, grip strength, back strength, push-ups (male), one-minute sit-ups (female), sit and reach, one foot stands with eyes closed, and choice reaction time.

Aged 40~59: Four items including grip strength, sit and reach, one foot stands with eyes closed, and choice reaction time.

■ Seniors

Aged 60~69: Five items including grip strength, sit and reach, one foot stands with eyes closed, choice reaction time, and 30-second chair stand.

3. Derivative Indicators

Derivative indicators include BMI, Quetelet Index, WHR (waist-to-hip ratio), pressure difference and vital capacity/weight ratio, which were calculated as follows:

$$\text{BMI} = \text{weight}/\text{height}^2 \text{ (kg/m}^2\text{)}$$

$$\text{Quetelet Index} = \text{weight}/\text{height} \times 1,000 \text{ (kg/cm)}$$

$$\text{WHR} = \text{waist circumference}/\text{hip circumference} \times 100\%$$

$$\text{Pressure difference} = \text{systolic blood pressure} - \text{diastolic blood pressure}$$

4. Health Indicators

The occurrence of dental caries, poor vision (mild, moderate and severe), myopia, and color vision deficiency were examined. Dental caries was indicated by the percentage of decay (%). The primary tooth decay indicators include rate of primary tooth decay (d), rate of primary tooth loss (m), rate of primary tooth filling (f) and primary tooth decay loss and filling rate (dmf=d+m+f). The permanent tooth decay indicators include permanent tooth decay (D), rate of permanent tooth loss (M), rate of permanent tooth filling (F), and permanent tooth decay loss and filling rate (DMF=D+M+F).

Poor vision was indicated by the rate and level of poor vision detected, and rate of myopia. An uncorrected visual activity of <5.0 is considered as poor vision, a 4.9 visual activity is considered as mild level of poor vision, a 4.6~4.8 visual activity indicates moderate level of poor vision, and ≤ 4.5 is considered as severe level of poor vision. Using refractive assessment can further assess the refractive error. Subjects were considered to be “nearsighted” when positive vision decreased and negative vision increased.

(III) Contents of Calculation

1. The valid sample size of each population group was calculated according to age groups.

2. The actual valid sample size of different age groups was calculated according to **Grouping (Item 1-4)** under Statistical Analysis.

3. The source of the subjects of each age group, including sampling sites and general information (including labor intensity of daily work, birth place, parish of residence, kindergarten and school attendance, educational level, occupation, etc.) were calculated according to **Grouping (Items 1-4)** under Statistical Analysis, i.e. frequency and cumulative frequency.

4. The frequency of questionnaire items, population percentage and the cumulative frequency and population percentage of all samples in each age group were calculated according to **Grouping (Items 1-4)** under Statistical Analysis.

In which:

① For young children: sample size, mean, standard deviation and the 3rd, 10th, 25th, 50th, 75th, 90th and 97th percentiles of birth weight and birth length of each age group were calculated respectively. Living habits including average accumulated sleeping hours per day, accumulated hours of playing computer games; information regarding physical exercises, occurrence of diseases, dental hygiene; and fitness literacy, were examined.

② For students, examined items include living habits such as average cumulative time spent on watching TV, watching videos and playing computer games per day, average sleeping time per day (including naps); Situations of Physical Education (P.E.) classes at schools including such as frequency of P.E. classes per week and self-reported perception on exercise intensity of each class; Situations on extracurricular physical exercises including exercise frequency, exercise duration, exercise intensity and types of exercises frequently participated; as well as the occurrence of diseases within the last five years, dental hygiene, and fitness literacy.

③ For adults and seniors, examined items include living habits such as daily sleeping hours, cumulative walking and sitting time; Situations of physical exercises such as the average exercise frequency per week, average duration of physical exercise each time, duration of persistent exercising, types of physical exercise frequently participated; as well as the occurrence of diseases within the last five years, knowledge about the physical fitness study, and fitness literacy.

5. The frequency, percentage of subjects and the total sample of cumulative frequency and percentage of subjects who were “frequent exerciser”, “occasional exerciser” or “non-exerciser” were calculated according to **Grouping (Items 2-4)** under Statistical Analysis. “Frequent exerciser” was defined as subjects who exercise three times or more per week, each time for 30 minutes or more with moderate intensity. Subjects who achieved one or two of the above exercise conditions but not all three conditions at the same time were defined as “occasional exerciser”. Subject who did not meet any of the above exercise condition were defined as “non-exerciser”.

6. Sample size, mean, standard deviation and the 3rd, 10th, 25th, 50th, 75th, 90th and 97th percentiles of all examined variables of each age group were calculated according to **Grouping (Items 1-4)** under Statistical Analysis.

7. Sample size, mean, standard deviation and the 3rd, 10th, 25th, 50th, 75th, 90th and 97th percentiles of the derivative indicators of each age group were calculated according to **Grouping (Items 1-4)** under Statistical Analysis.

8. Sample size, occurrence of dental caries (%) including primary and permanent tooth decay of each age group in **Grouping (Item 1)** under Statistical Analysis were calculated.

9. Sample size, occurrence of dental caries (%), poor vision, myopia, color vision deficiency (%) of each age group in **Grouping (Item 2)** under Statistical Analysis were calculated.

10. Individual sampling difference test and single factor variance analysis were used to examine the difference between all questionnaire items, examined variables, derivative indicators and health indicators among different age groups and genders.

(IV) Elaboration on Calculation Methods

1. Mean

Mean value indicates the average level or intensified trend of a group of observed values, and calculated with the following formula:

$$Mean = \frac{\sum x}{n}$$

In which: “ x ” indicates the observed value and “ n ” indicates the sample size.

2. Standard Deviation

Standard deviation indicates the variation of a group of observed values, where the smaller the standard deviation, the smaller the variation. Standard deviation is indicated by Sd and calculated with the following formula:

$$Sd = \sqrt{\frac{\sum x^2 - \frac{(\sum x)^2}{n}}{n-1}}$$

3. Percentile

Percentile is commonly used when the frequency distribution of the variables is not normal. If all the observed values are arranged in sequence from small to large, the values at the positions of 1~100 percent of all the observed values may be called 1st~100th percentiles respectively. It is indicated by P_x and calculated with the following formula:

$$P_x = X\% \times (n + 1)$$

4. t-Test (Test of difference t in mean values of two samples)

Calculated with the following formula:

$$t = \frac{|M_1 - M_2|}{\sqrt{S_{m1}^2 + S_{m2}^2}}$$

In which, M_1 represents the mean of indicator 1 and M_2 represents the mean of indicator 2; S_{m1} is the standard deviation of measurements (SEM) of indicator 1 and S_{m2} is the standard deviation of measurements of indicator 2. S_m (standard deviation) is calculated with the following formula:

$$S_m = \frac{Sd}{\sqrt{n}}$$

Table 1-15 Degree of freedom (n°) = $n_1 + n_2 - 2$. Significance of the difference is determined by the t-value as follows:

t	P	Significance of difference
$< t(n^{\circ})0.05$	> 0.05	No significant difference
$\geq t(n^{\circ})0.05$	≤ 0.05	Of significant difference (*)
$\geq t(n^{\circ})0.01$	≤ 0.01	Of highly significant difference (**)

Note : “**” $P < 0.01$, “*” $P < 0.05$ ◦

When the sample size $n \geq 1000$,

if $t < 1.96$, $P > 0.05$ indicates no significant difference between the two tested averages.

if $2.58 > t \geq 1.96$, $P \leq 0.05$ indicates significant differences found between the two tested averages.

if $t \geq 2.58$, $P \leq 0.01$ indicates highly significant differences found between the two tested averages.

5. Proportion

$$\text{Proportion} = \frac{\text{Number of Positive Samples}}{\text{Total number of sample examined}} \times 100\% \text{ (or } 1000\%)$$

6. Significance Test for Proportion

① Significant test of difference between sample rate and population rate.

When the observed samples are of fairly large number, the frequency distribution of the sampling proportion appears to be close to normal distribution. The difference significance of regularity test proportion of normal distribution may be applied and it is not necessary to check the t-value table. The standard deviation of proportion may be obtained from calculation according to total proportion, and then the difference between sampling proportion and total proportion is calculated to determine the multiple to that of the standard deviation, which is called u and its formula is:

$$u = \frac{|P - \pi|}{S_p} = \frac{|P - \pi|}{\sqrt{\frac{\pi(1 - \pi)}{n}}}$$

In which : P ----- sample proportion

π ----- proportion tested against (the proportion obtained from a large number of observations can be deemed as the proportion tested against)

S_p ----- standard deviation

② Significance test of difference in two proportions

The calculation formula is as follows:

$$u = \frac{|P_1 - P_2|}{S(p_1 - p_2)} = \frac{|P_1 - P_2|}{\sqrt{P(1 - P) \left(\frac{1}{n_1} + \frac{1}{n_2} \right)}}$$

In which : P_1 e P_2 ----- respective positive proportion of both samples

$S(P_1-P_2)$ ----- the difference in standard deviation of the two proportions

P ----- sum of the positive proportion of the two groups

n_1, n_2 ----- two sample sizes

Table 1-16 | U | , P and the difference significance

U	P	Significance of difference
< 1.96	> 0.05	No significant difference
≥ 1.96	≤ 0.05	Of significant difference (*)
≥ 2.58	≤ 0.01	Of highly significant difference (**)

Note : “**” $P < 0.01$, “*” $P < 0.05$.

(V) Statistical Tool

SPSS10.0 Statistical Package Software was used for statistic analysis.



Part II
Study Results

I. Young Children

(I) Physical Fitness Conditions of Young Children in 2020

1. Basic Information of the Subjects

Young children were divided into two categories according to gender, and then further classified into 8 age groups that differed by one year. Macao was divided into three sampling areas: the northern area, the central area and the southern area. From Nossa Senhora de Fátima (the northern area), 406 subjects (225 boys and 181 girls) were drawn from two sampling sites: Keang Peng School (kindergarten) and Hou Kong Middle School (kindergarten). From Santo António and S. Lázaro (the central area), 391 subjects (253 boys and 138 girls) were drawn from Pui Ching Middle School (kindergarten) and Chan Sui Ki Perpetual Help College (branch school). From Sé Catedral and S. Lourenço (the southern area), 316 subjects (191 boys and 125 girls) were selected from Pooi To Middle School (kindergarten: including branch school of Praia Grande and Taipa kindergarten) and Estrela do Mar School (kindergarten). The sample size in each age group, the distribution of sampling sites (kindergartens), and the residential distribution of subjects were shown in Tables 2-1-1-1, 3-1-1-1 and 3-1-1-2, respectively.

Table 2-1-1-1 Sample size in each age group

Age group	3 years	4 years	5 years	6 years	Total
Boys	232	194	230	13	669
Girls	143	129	165	7	444
Subtotal	375	323	395	20	1113

Early admission to kindergarten was gaining popularity in Macao. Swept by the prevailing trend, most young children start kindergarten when they are just turning 3, and enter primary schools at age 6 after 3 years of kindergarten attendance. Therefore, few 6-year-old children could be found in the sampling kindergartens, and the number of subjects aged 6 was insufficient for the representative sample size. Thus, the aged 6 group was excluded from statistical analysis and the following study in this part.

Among 1,093 subjects aged 3~5, 93.4% of boys and 93.4% of girls were born in Macao, followed by Hong Kong, other countries (regions) and Mainland China (Table 3-1-1-3). 97.8% of boys and 97.9% of girls attended full-day kindergarten, and none of them attended boarding school for kindergartens (Table 3-1-1-4). About 3/5 of the young children were under direct care of their parents and 2/5 of them were under the care of elderlies or babysitters (Table 3-1-1-5).

2. Lifestyle

The study on lifestyle of young children covered 6 areas: birth and feeding patterns, living habits, physical exercise, occurrence of diseases, dental hygiene, and health literacy. Basic information was as follows:

2.1 Birth and Feeding Patterns

As indicated in our study, full-term boys accounted for 84.7%, while those of early-term and late-term accounted for 13.0% and 2.3% respectively. Full-term girls accounted for 88.5%, while those of early-term and late-term accounted for 8.5% and 3.0% respectively. Full-term boys at age 3, 4 and 5 were 84.9%, 86.1% and 83.5%, respectively; and full-term girls at age 3, 4 and 5 were 88.8%, 88.4% and 88.5%, respectively (Table

3-1-2-1, Figure 2-1-1-1).

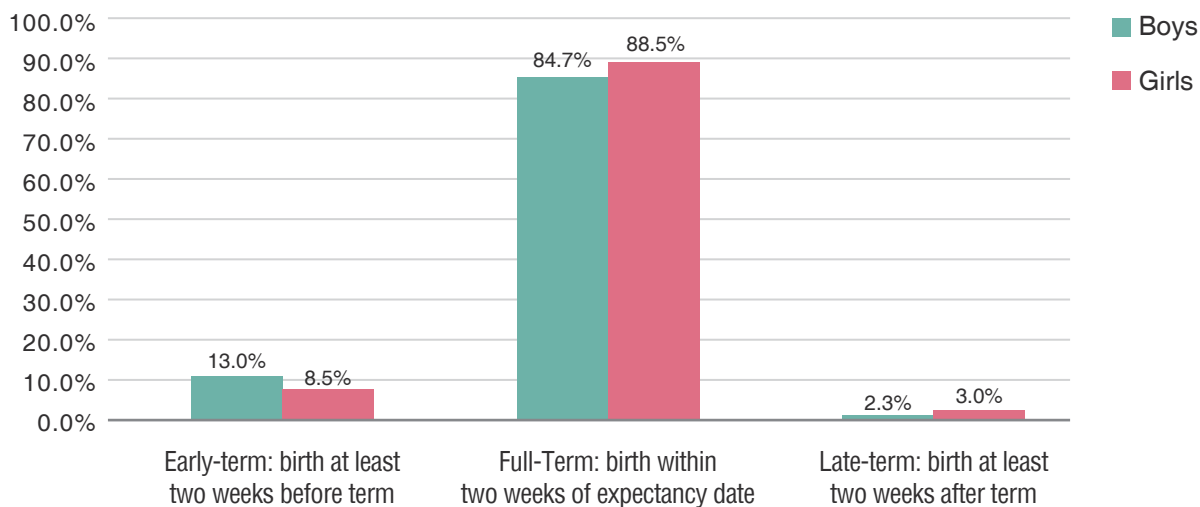

Figure 2-1-1-1 Proportion of gestational age at birth in young children

The average birth weight of young children was 3.3kg, in which the average birth weight of boys was 3.3kg, and so was that of girls. There was no significant difference in birth weight between gender or among age groups (Table 3-1-2-2).

The average birth length of young children was 48.9cm, in which The average birth length of boys and girls were 49.2cm and 48.4cm respectively. No significant difference in birth length between gender was found among age groups. However, the average birth length of boys was longer than that of girls, with significant difference only found in the aged 3 group ($P < 0.05$) (Table 3-1-2-3).

Feeding patterns of young children within four months after birth included breast feeding, formula feeding and mixed feeding, which accounted for 40.6%, 20.9% and 38.5%, respectively (Table 3-1-2-4, Figure 2-1-1-2).

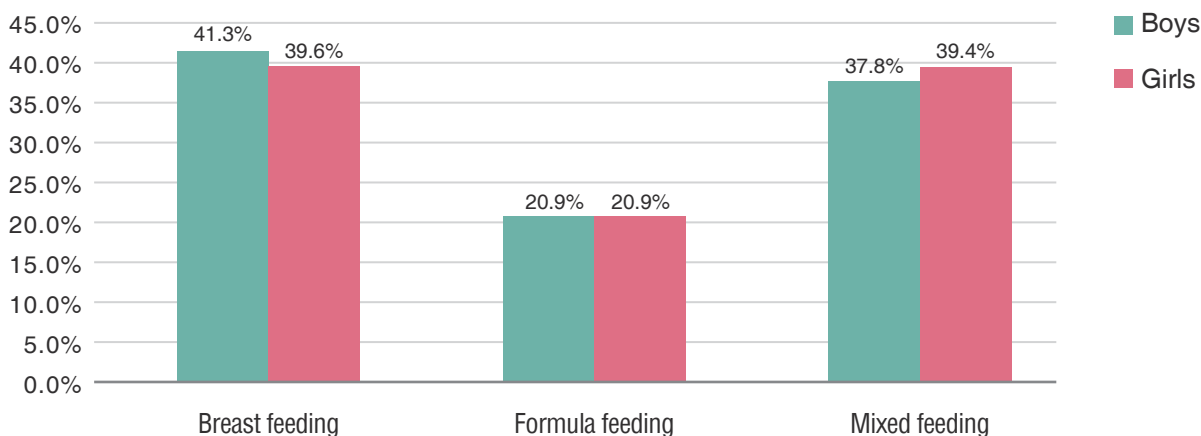

Figure 2-1-1-2 Proportion of feeding patterns within four months after birth in young children

2.2 Living Habits

The study on living habits included 6 aspects, namely, average nap time on school days, average nightly sleep time on school days, average nap time on rest days, average nightly sleep time on rest days, average time spent on using electronic devices on school days, and average time spent on using electronic devices on rest days.

Our study showed that on school days, the proportion of young children who napped for less than 2 hours per day at age 3, 4 and 5 were 66.4%, 69.4% and 70.6%, respectively; those who didn't nap at all accounted for 3.7%, 2.8% and 9.4% at age 3, 4 and 5, respectively. The proportion of young children who had an average nightly sleep time of 8~11 hours at age 3, 4 and 5 were 96.5%, 96.3% and 96.2% respectively, while 3% of them slept for 11 hours or more, and only 0.4% had less than 8 hours of sleep.

On rest days, the proportion of young children who napped for less than 2 hours per day at age 3, 4 and 5 were 25.9%, 30.0% and 37.2%, respectively; those who didn't nap at all accounted for 8.0%, 16.7% and 28.9% at age 3, 4 and 5, respectively; and more than half of them napped for 2 hours or more daily. The proportion of young children who had an average nightly sleep time of 8~11 hours at age 3, 4 and 5 were 85.9%, 87.0% and 85.8% respectively, while 13.2% of them slept for 11 hours or more, and only 0.6% had less than 8 hours of sleep (Tables 3-1-2-5, 3-1-2-6).

The 2020 study showed that on school days, the proportion of young children spending less than 1 hour (including those who basically didn't play), 1~2 hours, and 2 hours or more on electronic devices were 68.4%, 23.4% and 8.1%, respectively; whereas on rest days (weekends or holidays), the proportion of young children spending less than 1 hour (including those who basically didn't play), 1~2 hours, and 2 hours or more on such devices were 45.9%, 34.6% and 19.5%, respectively (Table 3-1-2-7, Figures 2-1-1-3 and 2-1-1-4).

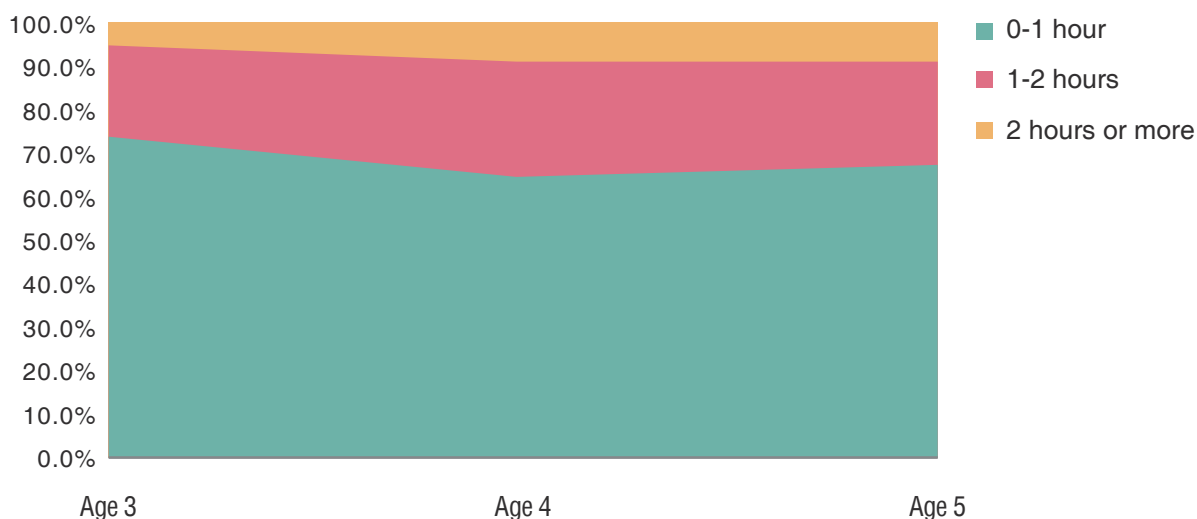

Figure 2-1-1-3 Proportion of average daily time spent using electronic devices on school days in young children (%)

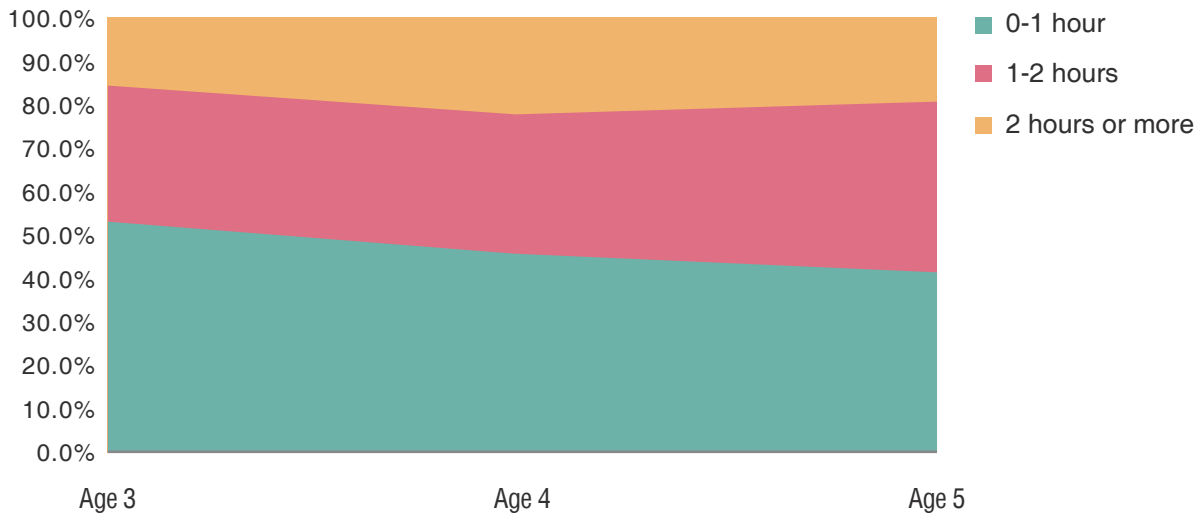

Figure 2-1-1-4 Proportion of average daily time spent using electronic devices on rest days in young children (%)

2.3 Physical Exercise

The top five physical exercises with highest participation rate were walking & running, cycling, swimming, sports games and dancing. Walking & running and cycling were the most popular physical exercises among boys, in which 65.9% of them enjoyed walking, 54.1% of them enjoyed running, and 46.6% enjoyed cycling. The most popular physical exercises among girls were walking & running and dancing, in which 67.5% of them enjoyed walking, 46.7% of them enjoyed running, and 46.7% enjoyed dancing (Table 3-1-2-8, Figures 2-1-1-5 and 2-1-1-6).

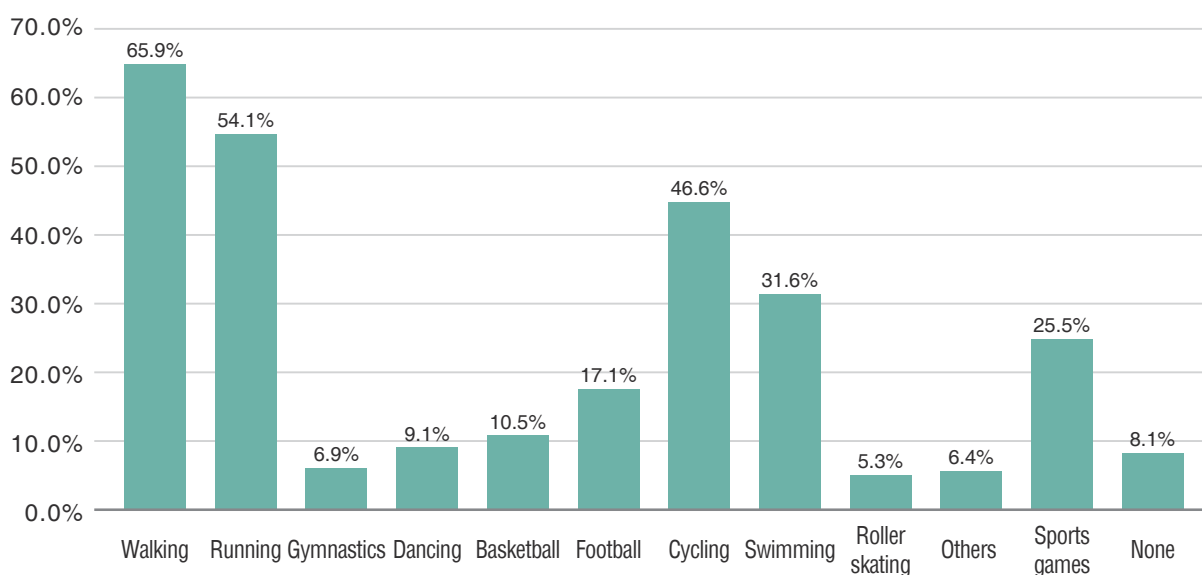

Figure 2-1-1-5 Proportion of physical exercises in young children (boys) (%)

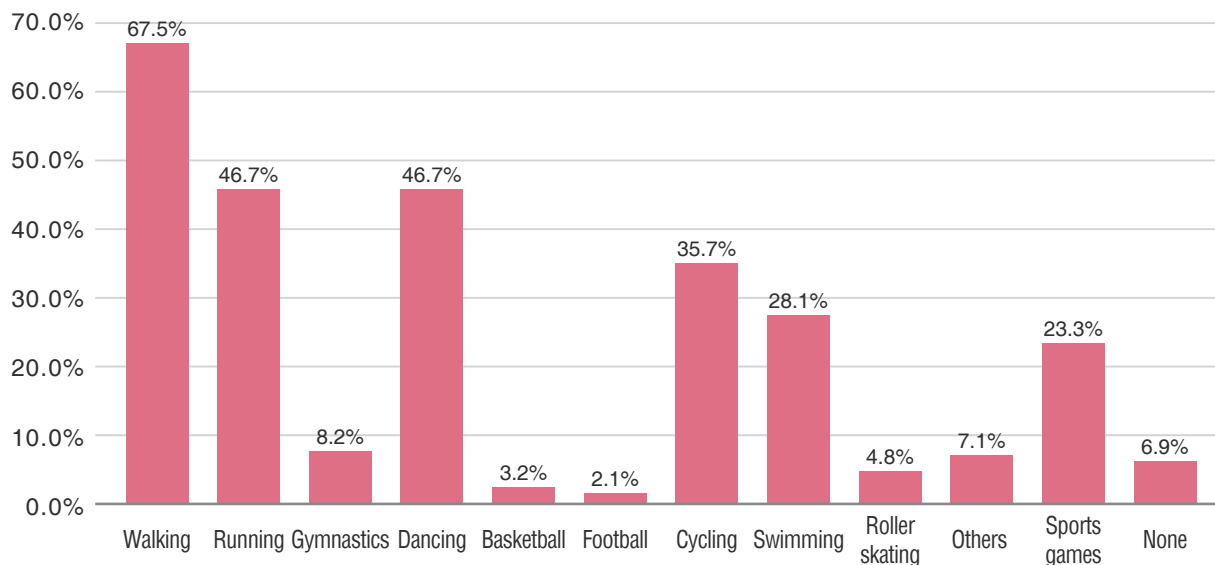

Figure 2-1-1-6 Proportion of physical exercises in young children (girls) (%)

In respect of physical exercise time, the proportion of young children spending less than 1 hour, 1~2 hours, and 2 hours or more on physical exercises daily on school days were 77.4%, 15.8% and 6.8%, respectively. On rest days, the proportion of young children spending less than 1 hour, 1~2 hours, and 2 hours or more on physical exercises daily were 33.2%, 44.2% and 22.6%, respectively (Table 3-1-2-9, Figures 2-1-1-7 and 2-1-1-8).

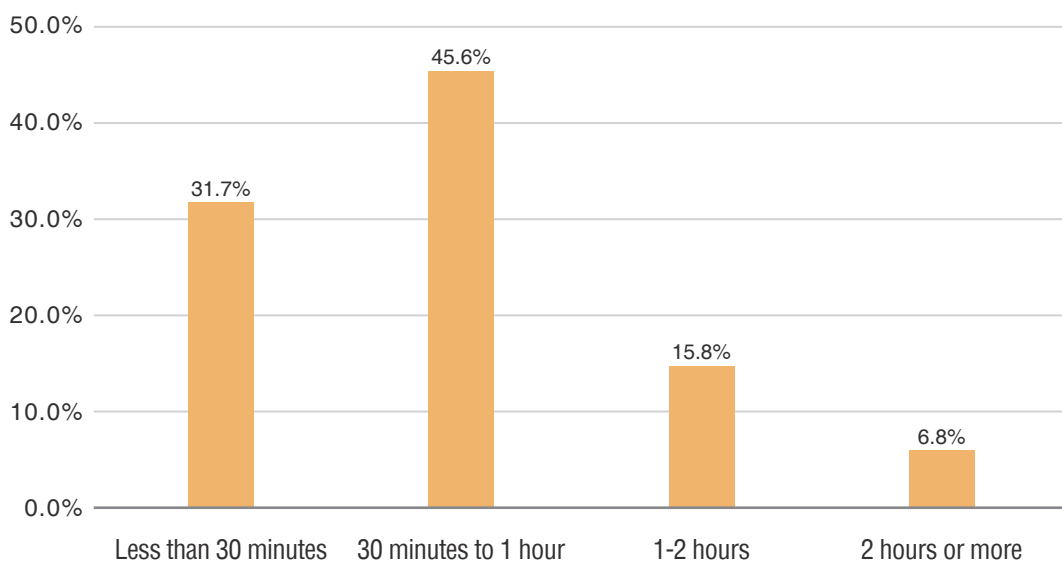

Figure 2-1-1-7 Proportion of average time spent on physical exercises on school days in young children (%)

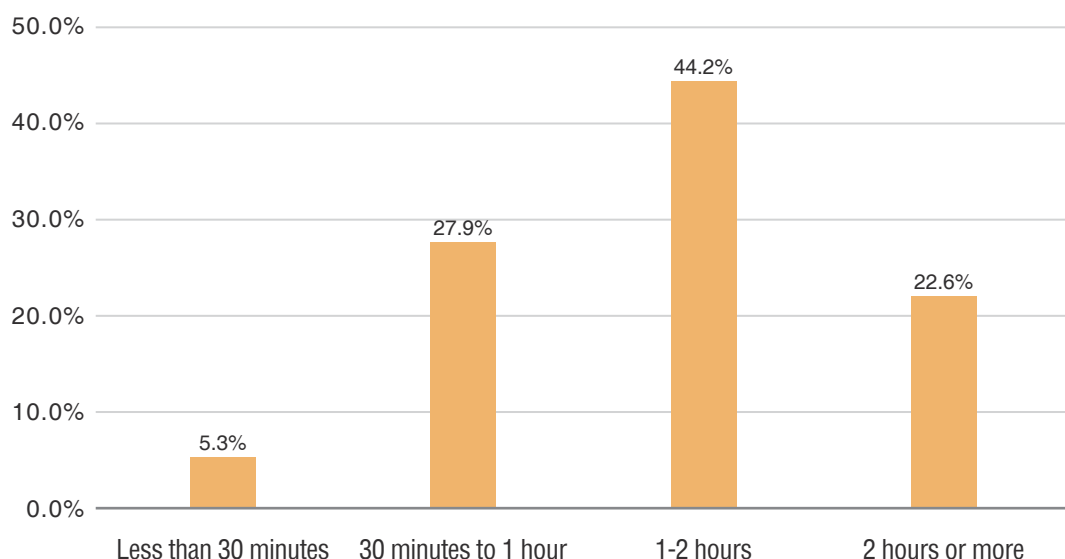

Figure 2-1-1-8 Proportion of average time spent on physical exercises on rest days in young children (%)

Our study indicated that 19.5% of young children signed up for training classes related to physical exercise, in which 14.2% were boys and 27.5% were girls. Among those who participated in training class currently, the proportion of young children spending less than 1 hour, 1~2 hours, and 2 hours or more on average per week were 31.7%, 60.2% and 8.1%, respectively (Tables 3-1-2-10 and 3-1-2-11).

2.4 Occurrence of Diseases

As indicated in the study, 46.5% of boys and 42.3% of girls had had diseases diagnosed by hospitals. The proportion of boys who had suffered from hospital-diagnosed diseases at age 3, 4 and 5 were 47.0%, 46.9% and 45.7%, respectively; the proportion of girls who had suffered from hospital-diagnosed diseases at age 3, 4 and 5 were 37.1%, 45.7% and 44.2%, respectively. Among young children who had had hospital-diagnosed diseases, diseases with high incidence rate were hand, foot and mouth disease (HFMD), acute bronchitis, eczema, gastroenteritis, and pneumonia, with a proportion of 41.3%, 35.7%, 26.8%, 23.6% and 19.0%, respectively (Tables 3-1-2-12, 3-1-2-13).

2.5 Dental Hygiene

Our study showed that 90.9% of young children brushed their teeth every day, with similar proportion recorded among aged 3, 4 and 5 groups, but only 9.1% used dental floss every day. The proportion of boys flossing their teeth reached a peak of 12.6% at age 5; and that of girls flossing their teeth reached a peak of 10.1% at age 4 (Tables 3-1-2-14 and 3-1-2-15).

Our study showed that 27.6% of boys had visited dental clinics for dental examination in the past 12 months, with a proportion of 17.2%, 26.8% and 38.7% at age 3, 4 and 5, respectively. Whereas for girls, there were 27.9%, and the proportion at age 3, 4 and 5 were 14.7%, 24.8% and 41.8%, respectively. The proportion of young children visiting dental clinics for dental examination tended to increase gradually with advancing age (Table 3-1-2-16). Moreover, 19.8% of boy's parents and 21.1% of girls' parents acknowledged the dental problems of their children, with a proportion of 8.6%, 23.2% and 28.3% at the aged 3, 4 and 5 groups of boys, respectively, and a proportion of 10.5%, 17.8% and 32.7% at the aged 3, 4 and 5 groups of girls, respectively. The proportion parents acknowledging their children's dental problems increased gradually with advancing age of their children

(Table 3-1-2-17). As for young children with dental caries, 65.3% of them had been to dental clinics for treatment (Table 3-1-2-18).

2.6 Fitness Literacy

Scientific fitness literacy means that people scientifically develop their fitness potential according to their respective strengths, actively interact with the environment and build a virtuous cycle from motivation, knowledge and understanding, attitude, ability, and skills to behavior and habits, and finally be able to consciously improve a certain level of lifelong participation in sports, fitness and other related activities. The evaluation of scientific fitness literacy consists of 4 first-level dimensions and 12 second-level dimensions. The first-level dimensions encompass cognition, attitude, ability and skills, and behavior and habit. More specifically, cognition refers to people's understanding and judgment produced by the information processing of objective things through perceiving, recognizing, remembering, conceiving, thinking and other actions; attitude refers to the stable psychological predisposition of an individual to a given object (person, concept, emotion or event, etc.). Ability in "ability and skill" refers to the physical abilities of individuals to perform basic movements, namely, the most essential and basic skills of body movements in their daily lives and social practice; whereas skill refers to sports skills, which are exercise movements acquired through learning. As for the term "behavior and habit", behavior has the same definition as physical fitness behavior in the traditional sense, and the most significant characteristic of habit is the length of persisting time of fitness behavior.

This study was based on the questionnaire survey conducted among Macao residents aged 3~79 in 2020. All the evaluative dimensions of scientific fitness literacy were examined in the age groups of 10~12, 13~18, 19~59 (subdivided into aged 19~29, 30~39, 40~49, 50~59 groups), and 60~79 (subdivided into the aged 60~69, 70+ groups), aside from the aged 3~6 and 7~9 groups where only ability & skills and behavior & habits were examined (because subjects of such ages are not able to accurately understand and express their cognition and attitude towards scientific fitness). The study results collected from 1,093 subjects aged 3~5 were analyzed as follows:

2.6.1 Personal Traits and Home Environment

As indicated in the study of personal traits of young children, 38.7% of parents believed their children were physically active. More specifically, 41.9% of the subjects were boys, of which the proportion recorded at age 3, 4 and 5 were 40.9%, 44.3% and 40.9%, respectively; 33.9% of them were girls, the proportion recorded at age 3, 4 and 5 were 37.1%, 31.8% and 32.7%, respectively. 2.3% of parents thought their children liked activities relatively quiet, of which 1.8% of the subjects were boys, with a proportion accounting for 2.6%, 1.5% and 1.3% at age 3, 4 and 5, respectively; 3.0% of them were girls, with a proportion accounting for 1.4%, 3.1% and 4.2%, at age 3, 4 and 5, respectively. Parents who thought their children were cautious with others accounted for 6.0%, in which 4.6% of the subjects were boys, with a proportion of 6.9%, 3.6% and 3.0% at age 3, 4 and 5, respectively, and 8.2% of them were girls, with a proportion of 11.9%, 9.3% and 4.2% at age 3, 4 and 5, respectively. Besides, 1.6% of the parents thought their children preferred staying alone, in which 1.7% of the subjects were boys, with a proportion accounting for 1.3%, 1.0% and 2.6% at age 3, 4 and 5, respectively, and 1.4% of them were girls, with a proportion accounting for 0.7%, 1.6% and 1.8% at age 3, 4 and 5, respectively.

With regard to the amount of exercise and exercise ability of young children, 5.0% of parents believed their children had an adequate amount of exercise compared to peers. Among the subjects, 4.9% of them were boys, in which the proportion recorded at age 3, 4 and 5 were 5.2%, 5.7% and 3.9%, respectively, and 5.3% of them were girls, in which the proportion recorded at age 3, 4 and 5 were 7.0%, 4.7% and 4.2%, respectively. 3.6% of parents believed that their children had excellent exercise ability compared to peers. In particular, 3.4% of the

subjects were boys, with a proportion accounting for 3.9%, 3.6% and 2.6% at age 3, 4 and 5, respectively, and 3.9% of them were girls, with a proportion accounting for 4.2%, 5.4% and 2.4% at age 3, 4 and 5, respectively.

As showed in the study of exercise frequency of young children's parents, 13.0% of fathers participated in physical exercise more than 3 times per week, among which fathers of boys accounted for 13.0%, with a proportion recorded in the aged 3, 4 and 5 groups accounting for 14.2%, 13.9% and 10.9%, respectively, and fathers of girls accounted for 13.0%, with a proportion recorded in the aged 3, 4 and 5 groups accounting for 10.5%, 14.0% and 14.5%, respectively. As for mothers, 6.1% of them participated in physical exercise more than 3 times per week. Among these mothers, 6.6% of them were mothers of boys, and the proportion recorded in the aged 3, 4 and 5 groups were 7.8%, 6.7% and 5.2%, respectively, and 5.5% of them were mothers of girls, and the proportion recorded in the aged 3, 4 and 5 groups were 6.3%, 3.1% and 6.7%, respectively.

According to our study of the average daily screen time of young children's parents, fathers who spent less than 2 hours in front of the screen on rest days contributed to a large proportion of 41.8%, in which fathers of boys accounted for 40.5%, and the proportion recorded in the aged 3, 4 and 5 groups were 39.2%, 39.2% and 43.0%, respectively, and fathers of girls accounted for 43.7%, and the proportion recorded in the aged 3, 4 and 5 groups were 41.3%, 43.4% and 46.1%, respectively. Moreover, a high proportion of 54.0% was observed in the average daily screen time of less than 2 hours among mothers. More specifically, mothers of boys accounted for 51.7%, and the proportion recorded in the aged 3, 4 and 5 groups were 52.6%, 51.5% and 50.9%, respectively, and mothers of girls accounted for 57.4%, and the proportion recorded in the aged 3, 4 and 5 groups were 53.8%, 59.7% and 58.8%, respectively.

The study results revealed that 35.2% of young children's parents were absolutely happy to pay for their children's physical activities.

The study results of the weight status of young children showed that 60.8% of parents believed that their children were at a healthy weight, in which 57.9% of the subjects were boys, with a proportion recorded in the aged 3, 4 and 5 groups accounting for 60.3%, 59.8% and 53.9%, respectively, and 65.0% were girls, with a proportion recorded in the aged 3, 4 and 5 groups accounting for 67.8%, 69.8% and 58.8%, respectively.

When choosing physical exercises for young children, it indicated that 90.4% of parents chose exercises based on children's own preferences, 70.6% of them purposefully encouraged their children to do physical exercises, and those who chose suitable exercises for their children accounted for 84.1%. In the case of being told that their children didn't like the chosen exercise, 33.9% of parents would allow their children to quit, 91% of them would ask their children to hold on for a while before making a decision, whereas 43.4% of them would insist their children to keep on participating if they thought it was good for their children.

Our study showed that on rest days, parents who spent 2~4 hours accompanying their children contributed to a high proportion of 35.0%. Among these parents, 34.5% of them were parents of boys, with a proportion recorded in the aged 3, 4 and 5 groups accounting for 32.8%, 35.1% and 35.7%, respectively, and 35.9% were parents of girls, with a proportion recorded in the aged 3, 4 and 5 groups accounting for 35.0%, 35.7% and 37.0%, respectively.

According to the study results of understanding and attitude of physical exercise of subjects, only 14.9% of them enjoyed the pleasure of having better performance and skills than others; 16.1% of them felt winning in competitions was more important; 38.0% believed they found the meaning of sports through competition; 48.6% felt accomplished to acquire a sports skill; and notably, 93.8% of them thought exercising was fun.

2.6.2 Community Environment

According to the study results of community environment, 32.8% of parents felt it was very convenient to go to parks, shopping malls or other places for leisure activities, in which 33.4% were parents of boys, with a proportion recorded in the aged 3, 4 and 5 groups accounting for 29.7%, 37.1% and 33.9%, respectively; while 32.0% were parents of girls, with a proportion recorded in the aged 3, 4 and 5 groups accounting for 27.3%, 37.2% and 32.1%, respectively. 10.9% of parents believed it was very safe for their children to play or exercise around their residential areas and 48.0% of them felt it was relatively safe, which made up a total of 58.9%. Among them, 59.0% were parents of boys, with a proportion recorded in the aged 3, 4 and 5 groups accounting for 56.9%, 59.8% and 60.4%, respectively; and 58.8% were parents of girls, with a proportion recorded in the aged 3, 4 and 5 groups accounting for 53.8%, 68.2% and 55.8%, respectively.

45.5% of parents thought the surroundings of their residence were of average level, and those who felt satisfied and extremely satisfied with their surroundings accounted for 33.8% and 5.4% respectively.

In parents' opinions, the top three environmental factors that limited their children's outdoor activities were: "Lack of recreational facilities suitable for children (53.2%)", "Lack of suitable venues (49.1%)", and "Poor environmental health (31.0%)".

In conclusion, the study of personal traits and family of young children in 2020 showed that the majority of parents believed their children were physically active, but only 5.0% of them believed their children had adequate amount of exercise compared to peers, which reflected that young children had a relatively low amount of physical exercise in general. Young children's fathers exercised more frequently than their mothers in a typical week, and their mothers had a higher screen time than fathers on rest days. 35.2% of parents were absolutely happy to pay for their children's physical exercises. Parents who chose exercises based on their children's own preferences accounted for the highest proportion, and 93.8% of parents thought exercising was fun. With regards to parental accompanying on rest days, 35.0% of parents spent 2~4 hours staying with their children. As for community environment, 32.8% of parents felt it was very convenient to go to parks, shopping malls or other places for leisure activities, but only 10.9% of them believed it was very safe for their children to play or exercise around their residential areas. Besides, parents who feel extremely satisfied with their surroundings accounted for merely 5.4%. In parents' opinions, there were three major environmental factors that limited their children's outdoor activities, namely, "Lack of recreational facilities suitable for children", "Lack of suitable venues", and "Poor environmental health", which indicated that residential environment needed to be improved, such as providing safety supporting services and recreational facilities.

3. Anthropometric Measurements

3.1 Length Indicators

The average height, sitting height and foot length of young children of both gender increased with advancing age. The average height of boys and girls was ranged from 98.7~111.9cm and 97.8~111.3cm, respectively. The average sitting height was ranged from 56.5~62.5cm and 56.0~62.1cm for boys and girls, respectively. As for the average foot length, it was ranged from 15.5~17.3cm and 15.5~17.1cm for boys and girls, respectively (Tables 3-1-3-1, 3-1-3-2 and 3-1-3-3). Our study indicated that the anthropometric indicators of young children increased substantially in 3 years. An increase of more than 10% was observed in height and sitting height. However, no significant difference in height, sitting height and foot length between gender was found in each age group (Figures 2-1-1-9, 2-1-1-10 and 2-1-1-11).

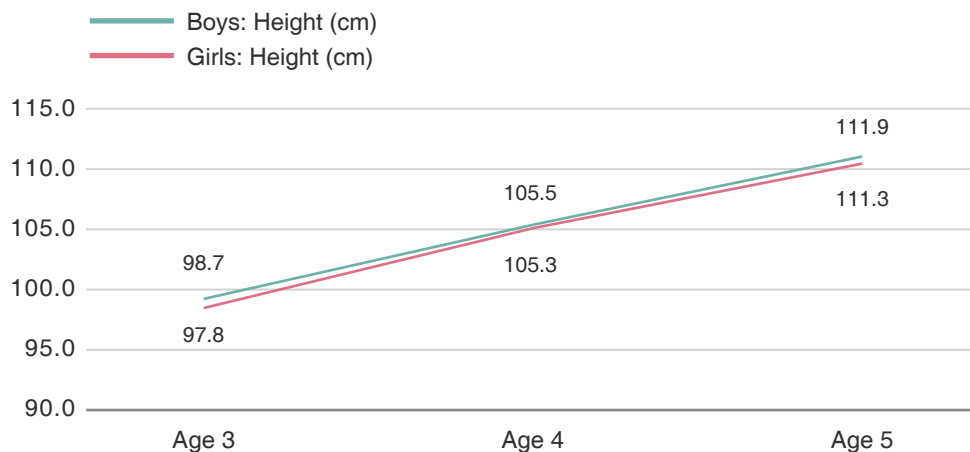

Figure 2-1-1-9 Average height of young children

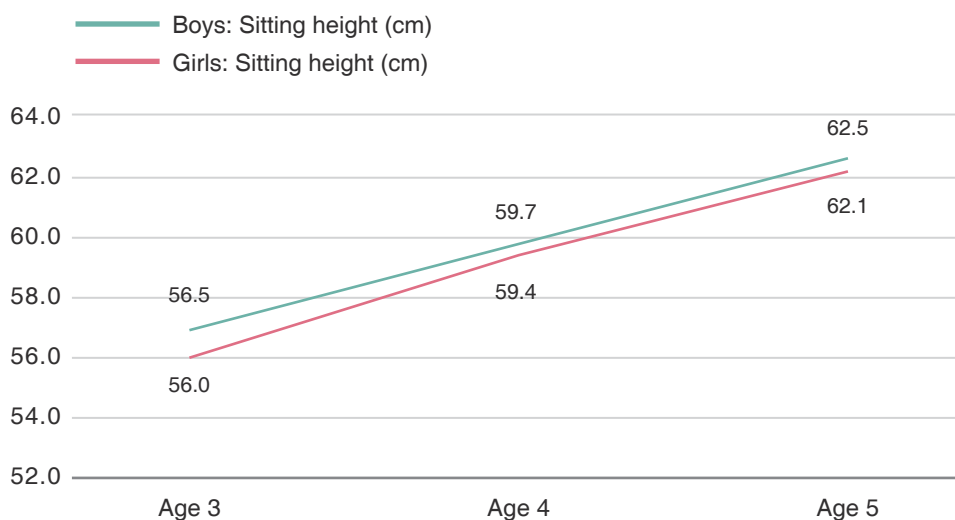

Figure 2-1-1-10 Average sitting height of young children

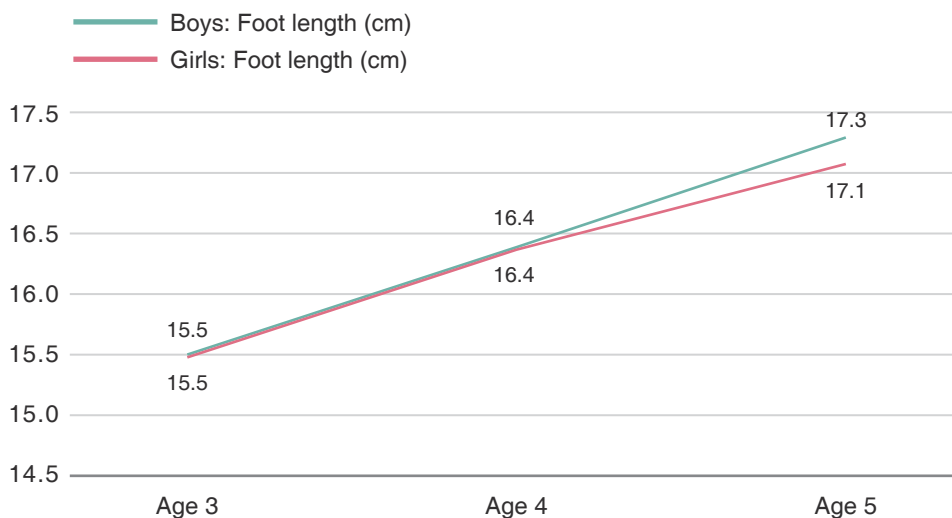

Figure 2-1-1-11 Average foot length of young children

3.2 Weight and BMI

The average weight of boys and girls both increased with advancing age. The average weight of boys and girls was ranged from 15.3~19.4kg and 14.8~18.8kg, respectively. An increase of more than 25% was observed in 3 years. In the aged 3 and 4 groups, the average weight of boys was higher than that of girls, with significant difference found between gender ($P < 0.05$) (Table 3-1-3-4, Figure 2-1-1-12).

The average BMI of boys decreased first then increased with advancing age. The average BMI of girls at age 4 was lower than that at age 3, but similar with that at age 5. The average BMI of boys and girls was ranged from 15.3~15.7 and 15.2~15.5, respectively. In addition, the average weight and BMI of boys and girls were basically similar, with no significant difference seen between gender in each age group (Table 3-1-3-5, Figure 2-1-1-13).

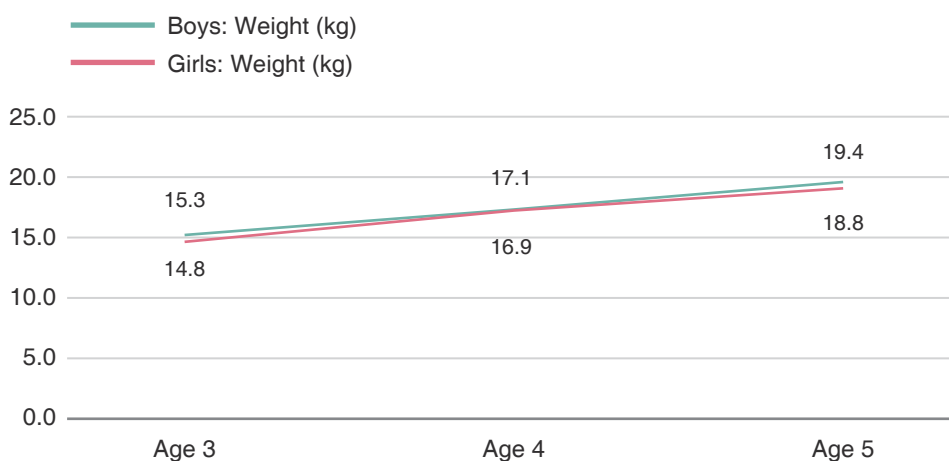

Figure 2-1-1-12 Average weight of young children

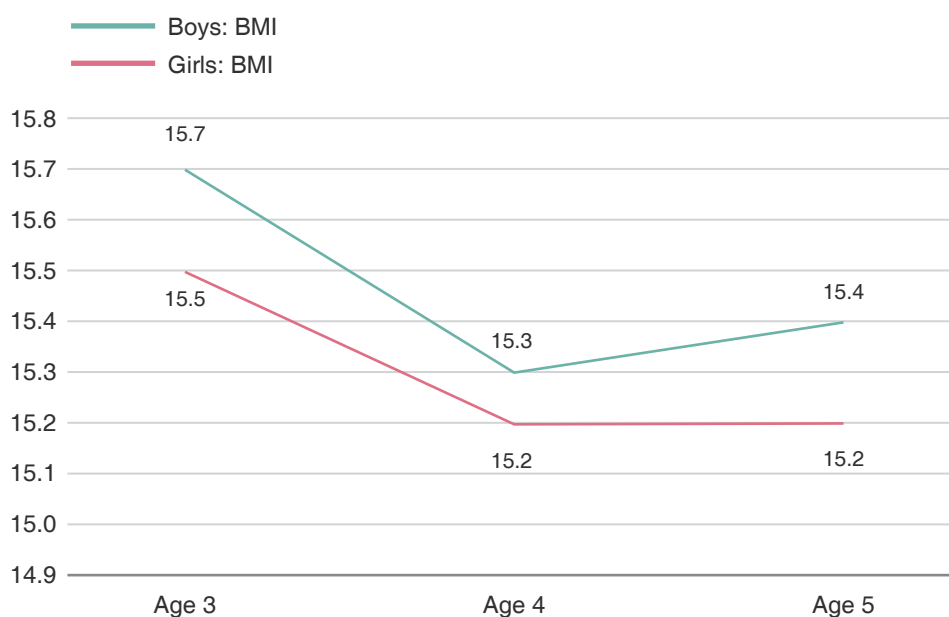

Figure 2-1-1-13 Average BMI of young children

The National Sample Standards (China Sport Science, 2021) was used to classify BMI overweight and obese categories of young children, and the critical value of underweight was used to evaluate the overweight and obesity status of Macao young children based on the International Obesity Task Force (IOTF) standard. Our study revealed that boys who were underweight, healthy, overweight and obese accounted for 4.3%, 80.0%, 11.0% and 4.7%, respectively; and girls who were underweight, healthy, overweight and obese accounted for 4.3%, 84.3%, 5.9% and 5.5%, respectively. The total prevalence of overweight and obesity of young children was lower at age 4 than at age 3 and 5, indicating that age 4 was a turning point of obesity of Macao young children (Table 3-1-3-6).

3.3 Circumference Indicators

The average chest, waist and hip circumferences of young children increased with advancing age. The average chest circumference of boys and girls was ranged from 52.7~56.3cm and 52.0~54.6cm, respectively. The average waist circumference of boys and girls was ranged from 48.6~51.6cm and 48.4~50.8cm, respectively. The average hip circumference was ranged from 54.7~59.3cm and 55.2~60.1cm, respectively. In the aged 4 groups, the average chest circumference of boys was higher than that of girls, whereas the average hip circumference of girls was higher than that of boys. Significant difference was found between gender ($P < 0.05$). As for the aged 5 groups, the average chest and waist circumferences of boys were both higher than those of girls, with significant difference observed between gender ($P < 0.05$). No significant difference between gender was observed in other age groups (Tables 3-1-3-7, 3-1-3-8, 3-1-3-9, Figures 2-1-1-14, 2-1-1-15, 2-1-1-16).

The average waist-to-hip ratio (WHR) of young children declined as age increased. The average WHR of boys and girls was ranged from 0.942~0.966 and 0.909~0.944, respectively. Among all the age groups, boys had a higher WHR than girls, with significant difference found between gender ($P < 0.05$) (Table 3-1-3-10, Figure 2-1-1-17).

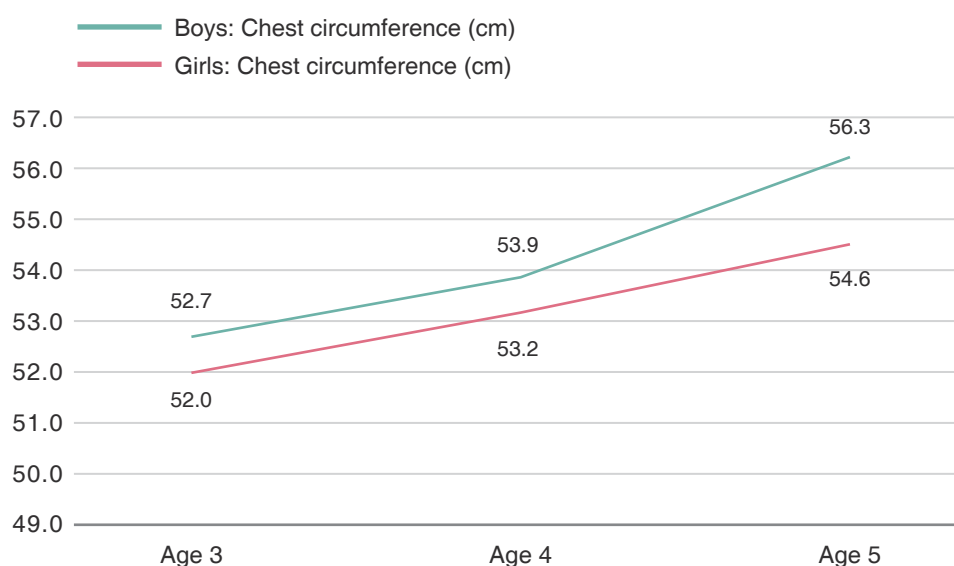

Figure 2-1-1-14 Average chest circumference of young children

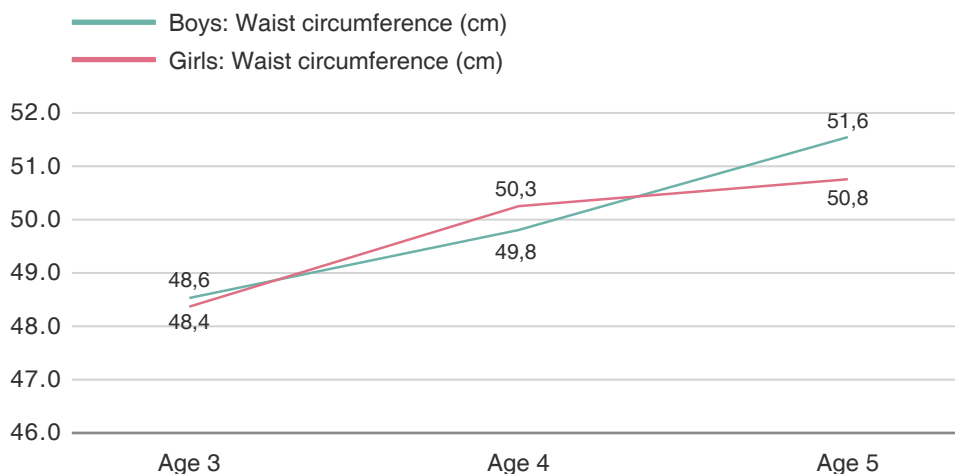

Figure 2-1-1-15 Average waist circumference of young children

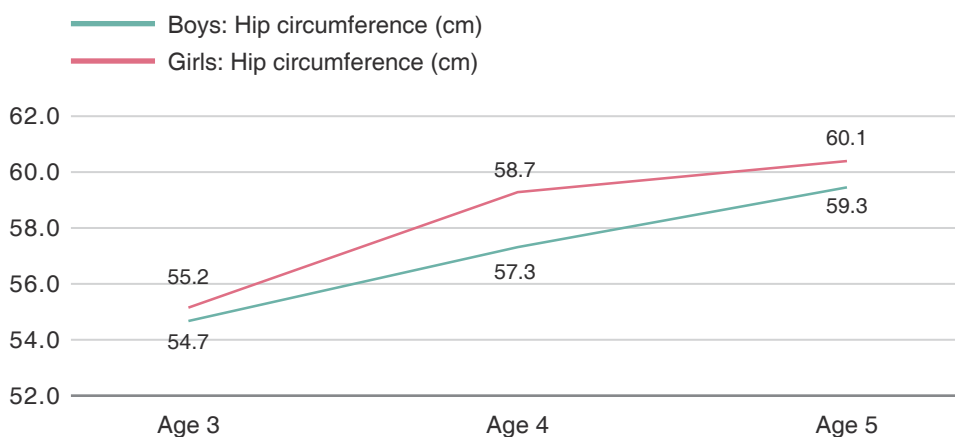

Figure 2-1-1-16 Average hip circumference of young children

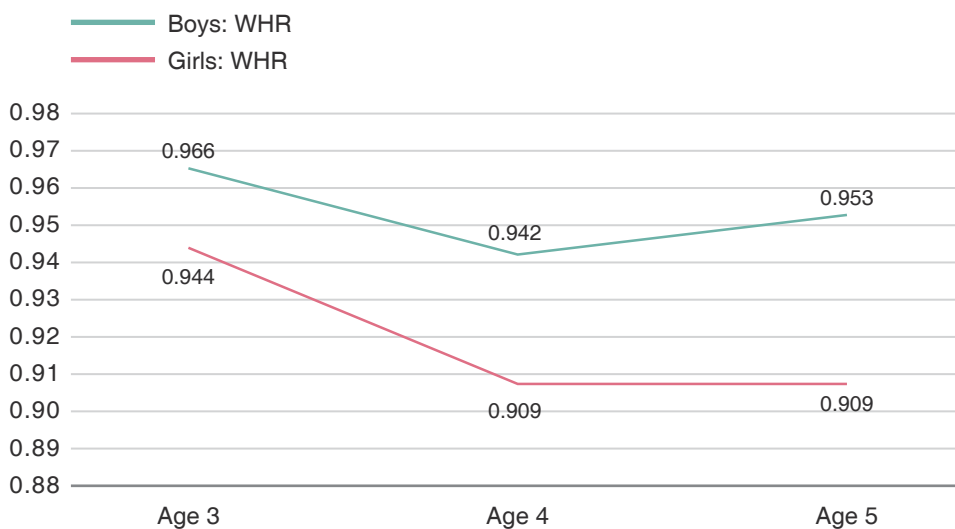

Figure 2-1-1-17 Average WHR of young children

3.4 Width Indicators

The average shoulder and pelvis width of boys and girls both increased with advancing age. The average shoulder width of boys and girls was ranged from 22.3~24.7cm and 22.4~24.8cm, respectively. The average pelvis width of boys and girls was ranged from 17.0~18.6cm and 17.1~18.8cm, respectively. The study results indicated that the shoulder and pelvis width of boys and girls increased by more than 10% in 3 years, but no significant difference was found in shoulder and pelvis width between gender in each age group (Tables 3-1-3-11 and 3-1-3-12, Figures 2-1-1-18 and 2-1-1-19).

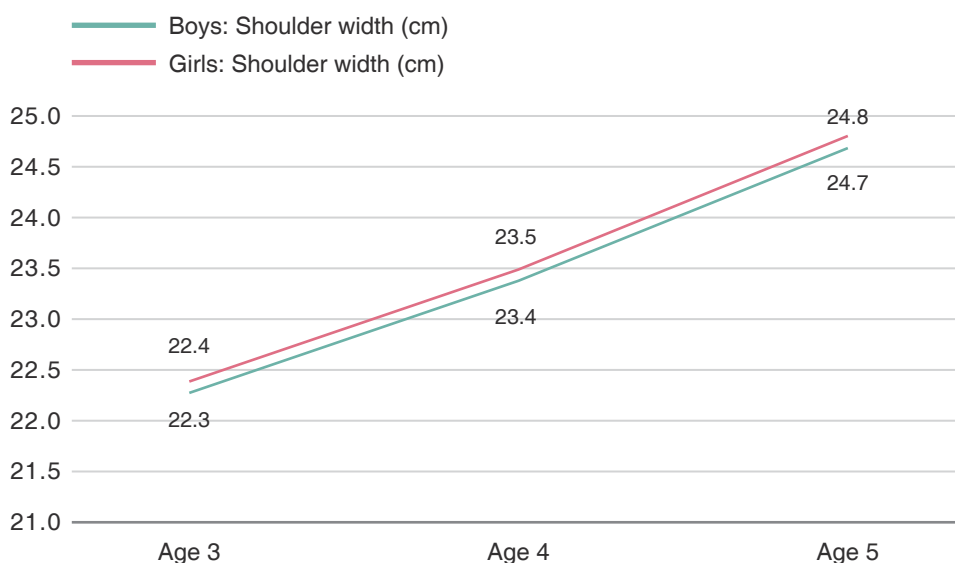

Figure 2-1-1-18 Average shoulder width of young children

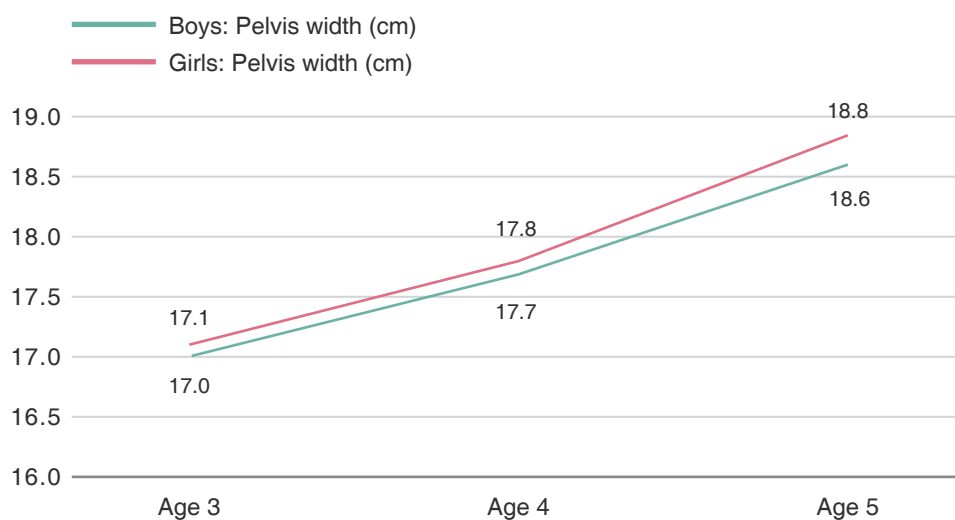

Figure 2-1-1-19 Average pelvis width of young children

3.5 Body Fat Percentage

Body composition monitor was used to measure body fat percentage in this study. The study results showed that body fat percentage of boys and girls was ranged from 17.2~17.8 and 21.4~21.8, respectively. Generally, girls had a higher body fat percentage than boys, with significant difference between gender seen in each age group ($P < 0.05$) (Table 3-1-3-13, Figure 2-1-1-20).

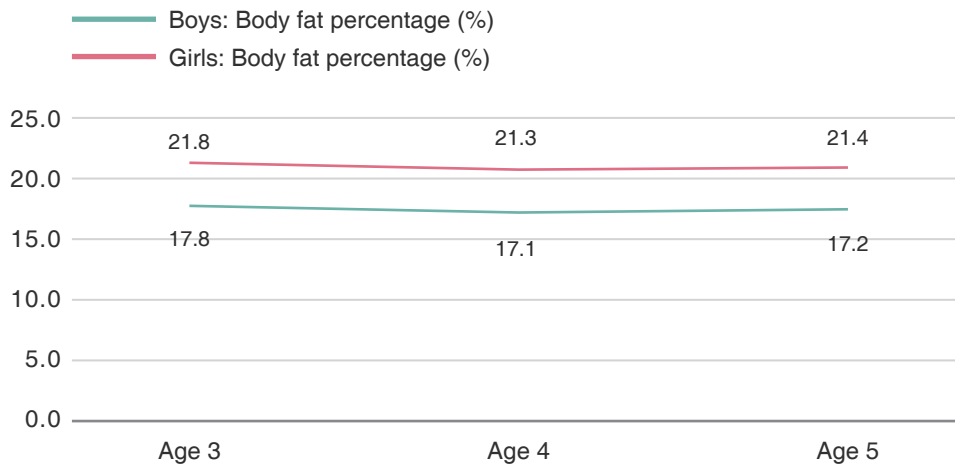

Figure 2-1-1-20 Average body fat percentage of young children

4. Physiological Function

The average resting heart rate of young children tended to decline with advancing age. The average resting heart rate of boys and girls was ranged from 101.3~95.4bpm and 100.5~97.3bpm, respectively. No significant difference in the resting heart rate was observed between gender in each age group (Table 3-1-4-1, Figure 2-1-1-21).

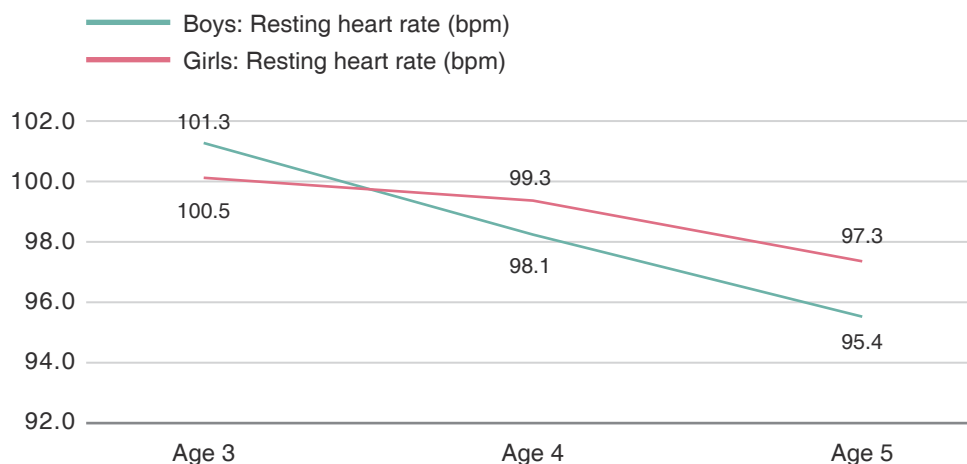

Figure 2-1-1-21 Average resting heart rate of young children

5. Physical Fitness

5.1 Speed and Agility

10m shuttle run and successive jumps with both feet were used to reflect the speed and agility of young children.

The average time for 10m shuttle run and successive jumps with both feet of boys was ranged from 7.2~9.8 seconds and 6.9~12.9 seconds, respectively. The average time for 10m shuttle run and successive jumps with both feet of girls was ranged from 7.4~10.1 seconds and 7.0~12.5 seconds, respectively (Tables 3-1-5-1 and 3-1-5-2). The study results indicated that speed and agility of young children tended to increase largely with advancing age. In the aged 5 groups, the average time for 10m shuttle run of boys was less than that of girls, with significant difference observed between gender ($P < 0.05$), reflecting that boys had faster speed than girls at age 5. In the aged 4 groups, the average time for successive jumps with both feet of girls was less than that of boys, with significant difference observed between gender ($P < 0.05$), which also meant girls had better agility than boys at age 4. No significant difference between gender was seen in other age groups (Figures 2-1-1-22, 2-1-1-23).

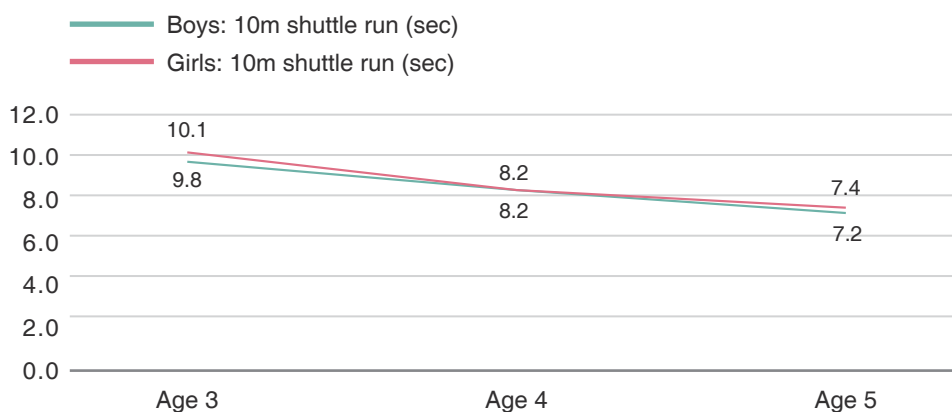

Figure 2-1-1-22 Average time of 10m shuttle run of young children

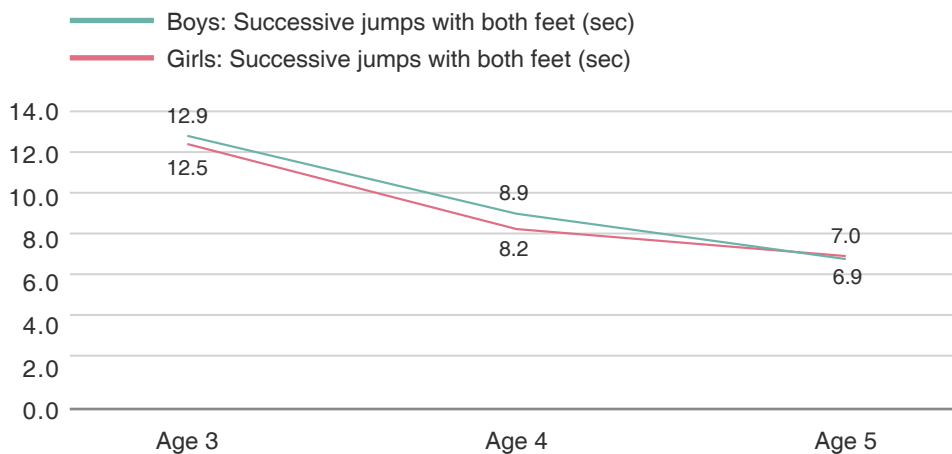

Figure 2-1-1-23 Average time of successive jumps with both feet of young children

5.2 Strength

Standing long jump and tennis ball distance throw were used to reflect the strength of young children.

The average distance of standing long jump and tennis ball distance throw of boys was ranged from 50.0~95.1cm and 2.5~5.1m, respectively; and those of girls was ranged from 49.3~91.0cm and 2.2~4.2m, respectively (Tables 3-1-5-3 and 3-1-5-4). Our study showed that the strength of both boys and girls tended to improve with advancing age, with the average distance of standing long jump of boys and girls increased by 90.2% and 84.7%, respectively, and the average distance of tennis ball distance throw of boys and girls increased by 104% and 90.9%, respectively. Boys had better strength than girls, and the difference between them increased with advancing age. The average distance of standing long jump of boys at age 5 was higher than that of girls at age 5. In the aged 3~5 groups, boys had better performance than girls in tennis ball distance throw, with significant difference observed between gender ($P < 0.05$). However, no significant difference between gender was seen in other age groups (Figures 2-1-1-24 and 2-1-1-25).

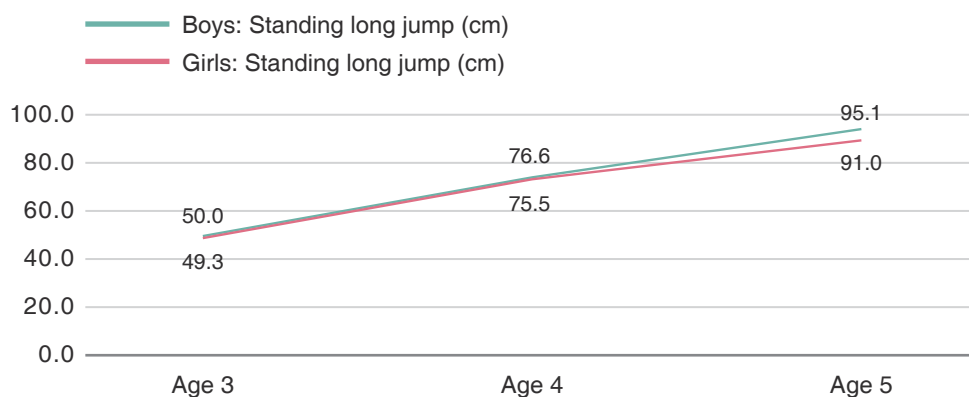

Figure 2-1-1-24 Average distance of standing long jump of young children

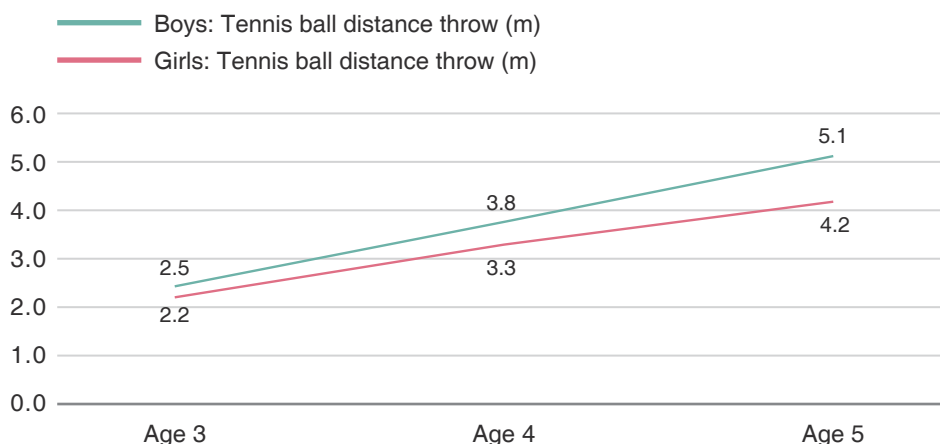

Figure 2-1-1-25 Average distance of tennis ball distance throw of young children

5.3 Flexibility

Sit and reach was used to reflect flexibility.

The average distance of sit and reach of boys and girls was ranged from 7.3~9.6cm and 9.5~11.5cm, respectively. As age increased, the average distance of sit and reach of boys declined, while that of girls varied irregularly, which indicated that flexibility of boys declined with advancing age (Table 3-1-5-5). The average distance of sit and reach of girls was higher than that of boys, with significant difference between gender found in each age group ($P < 0.05$) (Figure 2-1-1-26).

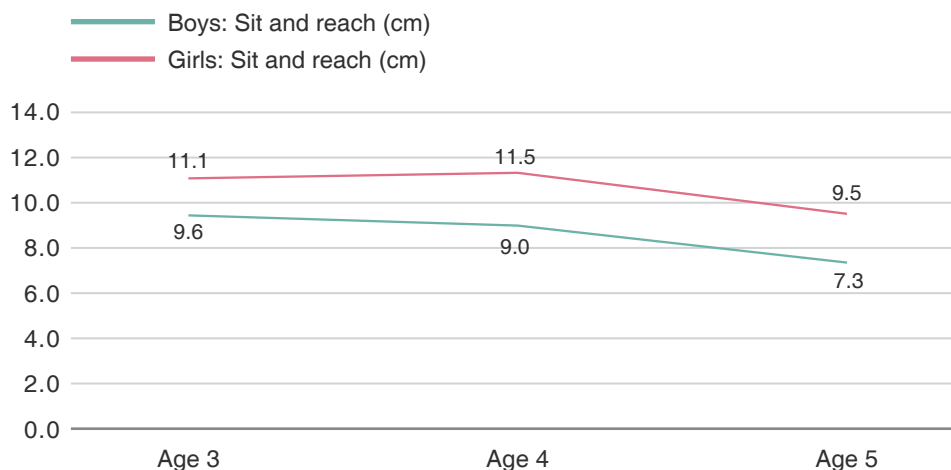

Figure 2-1-1-26 Average distance of sit and reach of young children

5.4 Balance

Walking on balance beam was used to reflect young children's balance ability. The manner of walking on balance beam and the completion time were used to evaluate the balance ability of young children.

In terms of manner of walking on balance beam, more and more boys and girls were able to finish the test (moving forward) as age increased. In each age group, girls had a higher proportion than boys in successful completion of the test. The proportion reached a peak of 99.4% in the aged 5 group of girls, and the proportion of moving slowly sideways and being unable to finish the test decreased gradually. However, no significant difference between gender was found in the different manners of walking (Table 2-1-1-2).

Table 2-1-1-2 Proportion of young children on the manner of walking on balance beam (%)

Gender	Manner of walking	Age (years)			Total
		3	4	5	
Boys	Moving forward	73.3	92.8	97.0	87.3
	Moving slowly sideways	25.0	6.7	3.0	11.9
	Unable to finish	1.7	0.5	0.0	0.8
Girls	Moving forward	76.1	95.3	99.4	90.6
	Moving slowly sideways	19.7	4.7	0.6	8.0
	Unable to finish	4.2	0.0	0.0	1.4

In terms of completion time, the average time for boys and girls was ranged from 24.4~8.8 seconds and 21.8~10.5 seconds, respectively. Young children at age 3 required the longest time while young children at age 5 required the shortest time to complete, indicating that the balance ability improved substantially with advancing age. No significant difference was found between gender (Table 3-1-5-6, Figure 2-1-1-27).

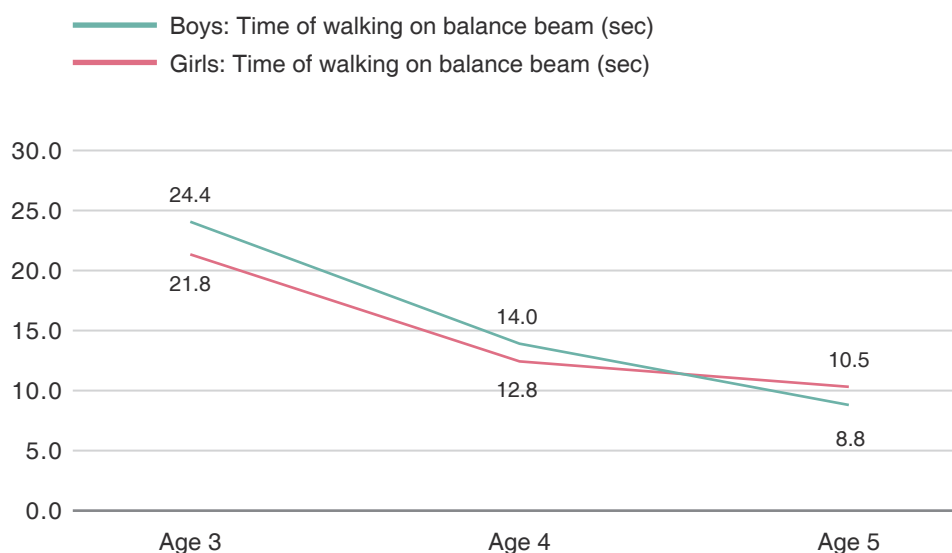

Figure 2-1-1-27 Average time of walking on balance beam of young children

6. Teeth

Occurrence of dental caries was reflected by the prevalence of decayed teeth (%), the prevalence of missing teeth (%), the prevalence of filled teeth (%) and the prevalence of decayed-missing-filled teeth (%). The prevalence of decayed primary teeth (d) meant the incidence rate of subjects having decayed primary teeth. The prevalence of missing primary teeth (m) referred to the incidence rate of missing primary teeth due to decay before the development of permanent teeth. The prevalence of filled primary teeth (f) meant the percentage of primary teeth with fillings. The prevalence of decayed-missing-filled primary teeth (dmf) referred to the total incidence rate of decay, missing and filling in primary teeth.

6.1 Occurrence of Decayed Primary Teeth

Among the young children aged 3~5, both boys and girls had the highest prevalence of decayed primary teeth at age 4, which accounted for 44.3% and 39.5% respectively. The prevalence of decayed primary teeth of boys was 25.4% at age 3 and 40.4% at age 5; while that of girls was 25.9% at age 3 and 39.4% at age 5. No significant difference between gender was found in each age group (Table 3-1-6-1, Figure 2-1-1-28).

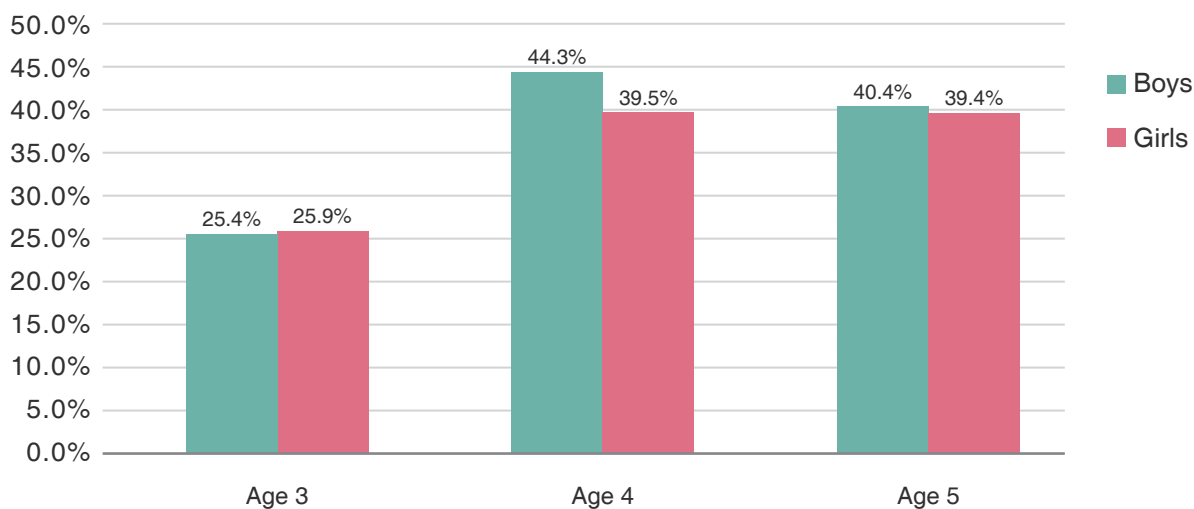

Figure 2-1-1-28 Prevalence of decayed primary teeth in young children (%)

The prevalence of filled primary teeth in boys increased gradually with advancing age, with the incidence rate at age 3, 4 and 5 accounting for 1.3%, 8.2% and 14.9%, respectively. The prevalence of filled primary teeth in girls was not observed until age 4, reaching a peak of 13.0%. The incidence rate in aged 5 girls was 8.3%. Boys had a higher prevalence of filled primary teeth than girls at age 5, with significant difference found between gender ($P < 0.05$).

The highest prevalence of missing primary teeth (m) in boys was 2.2% as recorded in the aged 4 group. The prevalence of missing primary teeth in girls appeared at age 4, with an incidence rate at age 4 and 5 accounting for 1.6% and 2.6% respectively. No significant difference between gender was observed.

The prevalence of decayed-missing-filled primary teeth (dmf) in boys increased gradually with advancing age, with an incidence rate at age 3, 4 and 5 accounting for 26.3%, 45.3% and 48.7%, respectively. The highest prevalence in girls was 44.2% as recorded in the aged 4 group. The incidence rate was 25.9% in aged 3 girls and 41.2% in aged 5 girls. No significant difference between gender was observed (Table 3-1-6-1, Figure 2-1-1-29).

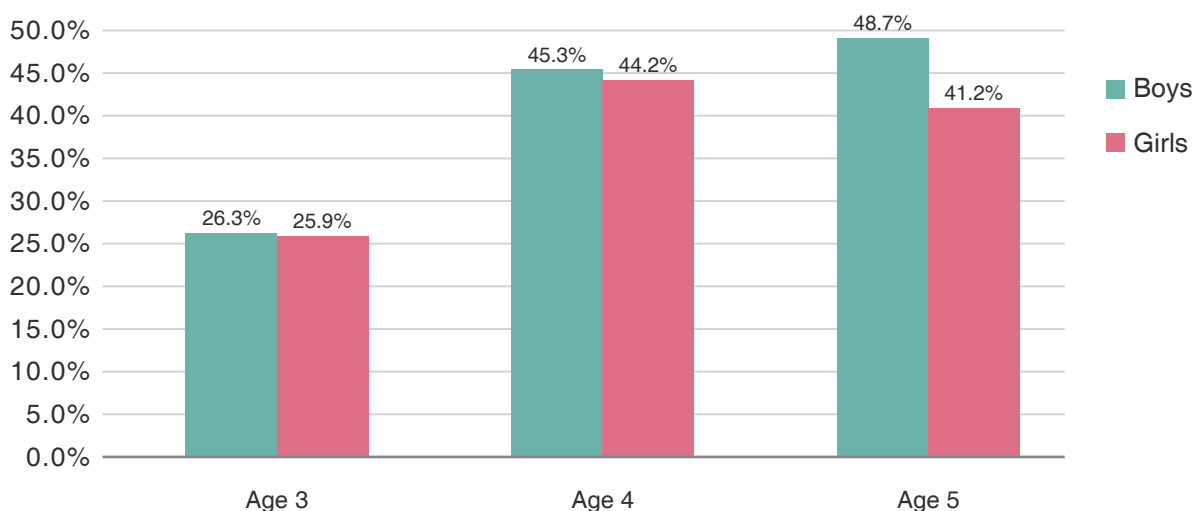

Figure 2-1-2-29 Prevalence of decayed-missing-filled primary teeth in young children (%)

6.2 Occurrence of Decayed Permanent Teeth

Occurrence of dental caries in permanent teeth was reflected by the prevalence of decayed permanent teeth (%), the prevalence of missing permanent teeth (%), the prevalence of filled permanent teeth (%) and the prevalence of decayed-missing-filled permanent teeth (%). The prevalence of decayed permanent teeth (D) meant the incidence rate of subjects having decayed permanent teeth. The prevalence of missing permanent teeth (M) referred to the incidence rate of missing permanent teeth due to caries. The prevalence of filled permanent teeth (F) meant the percentage of permanent teeth with fillings. The prevalence of decayed-missing-filled permanent teeth (DMF) referred to the total incidence rate of decay, missing and filling in permanent teeth.

The prevalence of decayed, missing and DMF permanent teeth occurred among young children at age 5. The prevalence of decayed permanent teeth in boys and girls accounted for 0.9% and 0.6%, respectively; the prevalence of missing permanent teeth in boys and girls accounted for 0.4% and 0.6%, respectively; the prevalence of decayed-missing-filled permanent teeth in boys and girls accounted for 0.9% and 0.6%, respectively, and there was no significant difference between gender in the prevalence of decayed, missing and DMF permanent teeth in each age group. The prevalence of filled permanent teeth occurred in aged 5 boys, with an incidence rate of 0.4%; whereas the prevalence of filled permanent teeth in girls was not observed at age 5. No significant difference between gender was observed in the prevalence of filled permanent teeth in each age group (Table 3-1-6-2).

(II) Comparison of 2020 and 2015 Results on the Physical Fitness Study of Macao Young Children

1. Overall Comparison of Young Children by Age

1.1 Comparison of Basic Information

1,008 and 1,093 samples were drawn randomly from the 2015 and 2020 physical fitness study of Macao young children (aged 3~5), respectively. The parishes where the sampling sites located were consistent in the two studies. Comparison of the two studies indicated that the average birth weight of boys and girls of each age group was higher in 2020 than that in 2015, with difference ranging from 0.1~0.2kg. Significant difference was seen in the aged 5 boys aged 5 ($P < 0.05$). Aside from a decrease of 0.3cm recorded in aged 3 girls, the average birth length of boys and girls of each age group in 2020 was all higher than that in 2015, with difference ranging from -0.3~1.5cm. Significant difference was seen in aged 5 boys ($P < 0.05$) (Table 2-1-2-1).

Table 2-1-2-1 Comparison of 2020 and 2015 results on birth weight and birth length in young children

	Age group (years)	Boys			Girls		
		2020	2015	Difference	2020	2015	Difference
Birth weight (kg)	3	3.3	3.2	0.1	3.3	3.1	0.2
	4	3.3	3.2	0.1	3.3	3.1	0.2
	5	3.4	3.2	0.2*	3.3	3.1	0.2
Birth length (cm)	3	49.2	48.7	0.5	47.9	48.2	-0.3
	4	49.1	49.0	0.1	48.5	48.0	0.5
	5	49.1	47.6	1.5*	48.8	48.4	0.4

Note: Difference equals to data in 2020 minus data in 2015.

The asterisk “*” means $P < 0.05$. This calculation method applies to subsequent tables.

Compared with the results in 2015, the proportion of young children who were breast-fed increased in 2020, whereas those who were formula-fed and mixed-fed decreased somehow. Significant difference was observed in the feeding patterns, except for the mixed feeding in girls ($P < 0.05$) (Table 2-1-2-2).

Table 2-1-2-2 Comparison of 2020 and 2015 results on feeding patterns in young children (%)

Feeding pattern	Boys			Girls		
	2020	2015	Difference	2020	2015	Difference
Breast feeding	41.3	21.4	19.9*	39.6	26.4	13.2*
Formula feeding	20.9	36.9	-16.0*	20.9	33.6	-12.7*
Mixed feeding	37.8	41.7	-3.9*	39.4	39.9	-0.5

Our study showed that comparing with the results in 2015, the proportion of young children spending more than 2 hours watching TV, video and playing video games daily decreased in 2020, but those spending less than 1 hour and 1~2 hour increased, without significant difference found between 2015 and 2020. As for the physical exercises in which young children participated, the proportion of young children who enjoyed dancing and swimming increased in 2020, whereas those who chose other physical exercises all decreased. Significant difference between 2015 and 2020 was found in dancing and swimming ($P < 0.05$) (Tables 2-1-2-3, 2-1-2-4).

Table 2-1-2-3 Comparison of 2020 and 2015 results on average daily accumulated time spent on watching TV, video and playing video games in young children (%)

Year	Less than 1 hour	1~2 hours	2 hours or more
2020	62.0	26.6	11.3
2015	61.1	25.8	13.0
Difference	0.9	0.8	-1.7

Table 2-1-2-4 Comparison of 2020 and 2015 results on the type of physical exercises participated by young children (%)

Year	Gymnastics	Dance	Ball games	Bicycling	Swimming	Roller skating
2020	7.4	24.2	18.8	42.3	39.3	3.3
2015	8.8	17.5	21.8	43.9	25.9	3.9
Difference	-1.4	6.7*	-3.0	-1.6	13.4*	-0.6

As indicated in the study of dental hygiene, the proportion of young children who brushed their teeth every day increased from 88.7% in 2015 to 90.9% in 2020, and the proportion of young children using dental floss also increased from 3.9% in 2015 to 9.1% in 2020. Among parents who acknowledged the dental problem of their children, the proportion of them who had brought their children to dental clinics for treatment increased from 54.9% in 2015 to 65.3% in 2020, which indicated that the awareness of dental care had been improved in the previous five years in Macao.

1.2 Comparison of Study Indicators

Compared with the results in 2015, among the boys aged 3~5, their resting heart rate, shoulder width, pelvis width, chest circumference, waist circumference, hip circumference and successive jumps with both feet somewhat increased in 2020 with a difference ranging from 2.0%~6.0%; standing long jump, 10m shuttle run, tennis ball distance throw and walking on balance beam all decreased, with a difference ranging from 2.7%~12.7%. In particular, a decrease of more than 10% was recorded in walking on balance beam. Refer to Figure 2-1-2-1.

Compared with the results in 2015, among girls aged 3~5, their indicators such as resting heart rate, shoulder width, pelvis width, chest circumference, waist circumference, hip circumference, successive jumps with both feet, sit and reach and standing long jump somewhat increased in 2020, with a difference ranging from 1.1%~5.0%; while the indicators of foot length, tennis ball distance throw, 10m shuttle run and walking on balance beam decreased, with the a difference ranging from 1.3%~3.1%. Refer to Figure 2-1-2-2.

It is noteworthy that young children were suspended from school and stayed at home for about half a year due to the COVID-19 pandemic. They took the physical fitness test in less than one month after resuming classes in September. In such a short time, young children were not able to fully adapt to the group living and learning environment of kindergartens, and physical training failed to be fully implemented in teaching. However, young children have a relatively strong plasticity in physical fitness. They participated in the collective physical fitness test without sufficient group living experience and systematic learning, which posed a certain impact on the test results of young children. The decline of young children’s physical fitness in this study might be attributed to these above factors.

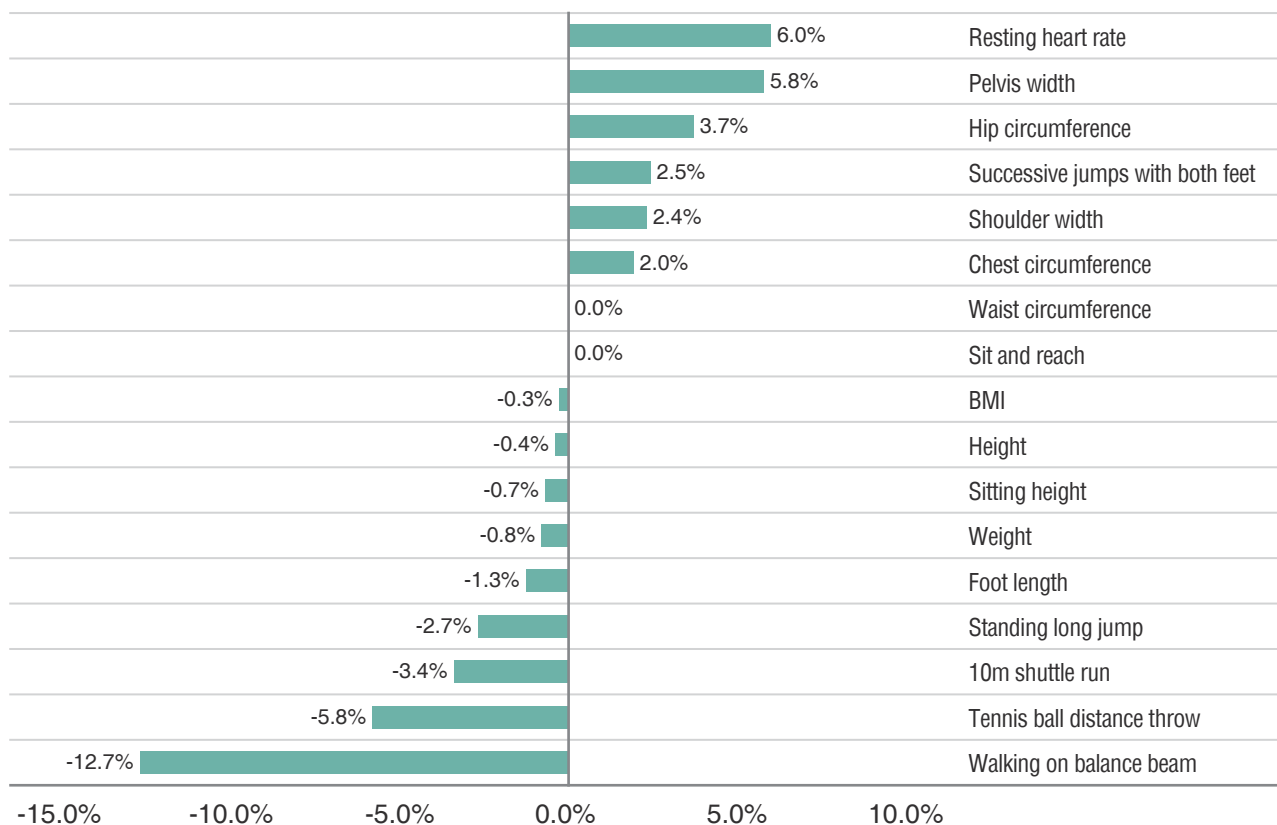

Figure 2-1-2-1 Comparison of 2020 and 2015 results in boys aged 3~5

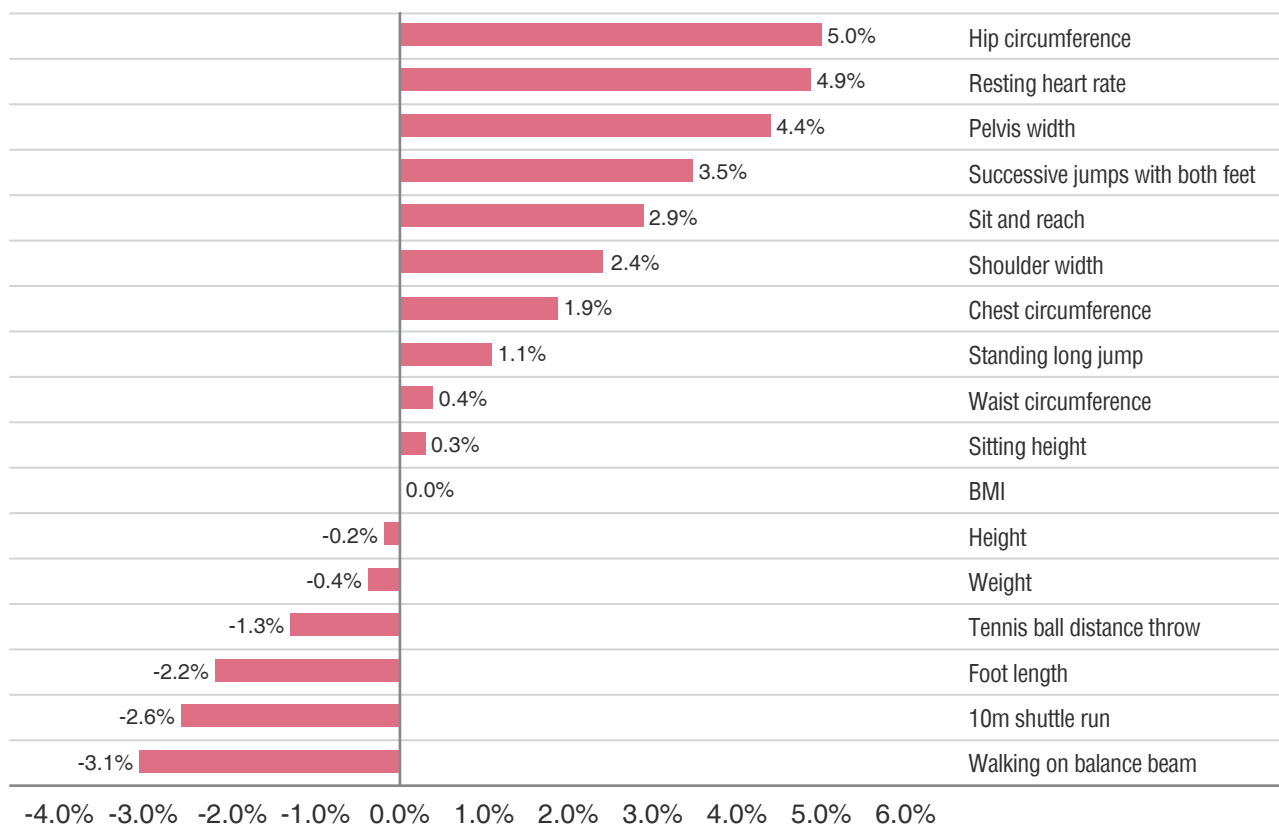

Figure 2-1-2-2 Comparison of 2020 and 2015 results in girls aged 3~5

2. Comparison of Young Children by Age

2.1 Comparison of Anthropometric Measurements

2.1.1 Length Indicators

The results of the two studies showed that except for an increase observed in girls aged 4, the average height of young children in other age groups all decreased in 2020. The average height of boys in the aged 4 group decreased by 0.9cm, which differed significantly ($P < 0.05$) (Table 2-1-2-5).

Compared with the results in 2015, the average sitting height of boys aged 3 and 4 decreased in 2020, with significant difference found in the aged 3 group ($P < 0.05$). The average sitting height remained basically stable in boys aged 5 and girls aged 3, while increased in girls aged 4~5. No significant difference was found in each age group (Table 2-1-2-6).

The average foot length of boys and girls both decreased, and that of boys aged 5 remained stable. The average foot length of girls in the aged 4~5 groups differed significantly ($P < 0.05$) (Table 2-1-2-7).

Table 2-1-2-5 Comparison of 2020 and 2015 results on average height in young children aged 3~5 (cm)

Age group	Boys			Girls		
	2020	2015	Difference	2020	2015	Difference
3 years	98.7	99.0	-0.3	97.8	98.3	-0.5
4 years	105.5	106.4	-0.9*	105.3	105.0	0.3
5 years	111.9	112.0	-0.1	111.3	111.8	-0.5

Note: Difference equals to data in 2020 minus data in 2015.

The asterisk “*” means $P < 0.05$. This calculation method applies to subsequent tables.

Table 2-1-2-6 Comparison of 2020 and 2015 results on average sitting height in young children aged 3~5 (cm)

Age group	Boys			Girls		
	2020	2015	Difference	2020	2015	Difference
3 years	56.5	57.3	-0.8*	56.0	56.0	0.0
4 years	59.7	60.2	-0.5	59.4	59.2	0.2
5 years	62.5	62.5	0.0	62.1	61.8	0.3

Table 2-1-2-7 Comparison of 2020 and 2015 results on average foot length in young children aged 3~5 (cm)

Age group	Boys			Girls		
	2020	2015	Difference	2020	2015	Difference
3 years	15.5	15.6	-0.1	15.5	15.6	-0.1
4 years	16.4	16.5	-0.1	16.4	16.6	-0.2*
5 years	17.3	17.3	0.0	17.1	17.4	-0.3*

2.1.2 Weight and BMI

Compared with the results in 2015, the average weight of boys aged 4~5 and girls aged 3 and 5 declined slightly in 2020. More specifically, the average weight of boys and girls decreased by 0.1~0.3kg and 0.1~0.2kg, respectively. Significant difference was seen among boys in the aged 4 group ($P < 0.05$) (Table 2-1-2-8).

Compared with the results in 2015, the average BMI in 2020 decreased by 0.1 in boys aged 4~5 and girls aged 4, while increased in boys and girls aged 3, and remained stable in girls aged 5. No significant difference was observed in each age group (Table 2-1-2-9).

Table 2-1-2-8 Comparison of 2020 and 2015 results on average weight in young children aged 3~5 (kg)

Age group	Boys			Girls		
	2020	2015	Difference	2020	2015	Difference
3 years	15.3	15.3	0.0	14.8	14.9	-0.1
4 years	17.1	17.4	-0.3*	16.9	16.9	0.0
5 years	19.4	19.5	-0.1	18.8	19.0	-0.2

Table 2-1-2-9 Comparison of 2020 and 2015 results on average BMI in young children aged 3~5

Age group	Boys			Girls		
	2020	2015	Difference	2020	2015	Difference
3 years	15.7	15.6	0.1	15.5	15.3	0.2
4 years	15.3	15.4	-0.1	15.2	15.3	-0.1
5 years	15.4	15.5	-0.1	15.2	15.2	0.0

According to the BMI classification of overweight and obesity in the National Sample Standards (China Sport Science, 2021), and the critical value of underweight of the International Obesity Task Force (IOTF) standard, the comparison of the two studies indicated that firstly, the prevalence of overweight in boys increased by 1.7% in 2020, whereas that of obesity decreased by 0.9%, totaling an increase of 0.8%; the prevalence of overweight in girls decreased by 2.0%, whereas that of obesity increased by 2.7%, totaling an increase of 0.7%; secondly, the prevalence of underweight slightly increased by 0.6% and 1.0% in boys and girls, respectively. Refer to Table 2-1-2-10.

Table 2-1-2-10 Comparison of 2020 and 2015 results on underweight, overweight and obesity in young children aged 3~5

Gender	Age group	Underweight			Overweight			Obesity		
		2020	2015	Difference	2020	2015	Difference	2020	2015	Difference
Boys	3 years	4.5%	7.0%	-2.5%	10.8%	10.7%	0.1%	3.9%	3.4%	0.5%
	4 years	5.4%	3.0%	2.4%	11.9%	8.4%	3.5%	2.6%	6.7%	-4.1%
	5 years	3.6%	3.1%	0.5%	10.4%	8.6%	1.8%	7.4%	6.8%	0.6%
	Total	4.3%	3.7%	0.6%	11.0%	9.3%	1.7%	4.7%	5.6%	-0.9%
Girls	3 years	5.1%	5.5%	-0.4%	5.6%	7.8%	-2.2%	6.3%	3.1%	3.2%
	4 years	4.0%	3.7%	0.3%	6.2%	8.4%	-2.2%	3.9%	3.1%	0.8%
	5 years	4.4%	2.2%	2.2%	6.1%	7.8%	-1.7%	6.1%	2.2%	3.9%
	Total	4.3%	3.3%	1.0%	5.9%	7.9%	-2.0%	5.5%	2.8%	2.7%

Note: BMI classification of overweight, obesity refers to National Sample Standards (China Sport Science, 2021); critical value of underweight refers to IOTF standard

2.1.3 Circumference Indicators

The results of the two studies indicated that the chest circumference of boys and girls were higher in 2020. Significant difference was found in all age groups except the aged 5 group of girls ($P < 0.05$) (Table 2-1-2-11).

Compared with the results in 2015, the average waist circumference in 2020 remained stable in boys of each age group, while it increased by 0.1~0.2cm in girls of each age group. No significant difference was found in each age group (Table 2-1-2-12).

Compared with the results in 2015, the average hip circumference of boys and girls increased in each age group in 2020. Significant difference was found in each age group between the two studies ($P < 0.05$) (Table 2-1-2-13).

Table 2-1-2-11 Comparison of 2020 and 2015 results on average chest circumference in young children aged 3~5 (cm)

Age group	Boys			Girls		
	2020	2015	Difference	2020	2015	Difference
3 years	52.7	51.4	1.3*	52.0	50.4	1.6*
4 years	53.9	53.2	0.7*	53.2	52.3	0.9*
5 years	56.3	55.3	1.0*	54.6	53.9	0.7

Table 2-1-2-12 Comparison of 2020 and 2015 results on average waist circumference in young children aged 3~5 (cm)

Age group	Boys			Girls		
	2020	2015	Difference	2020	2015	Difference
3 years	48.6	48.6	0.0	48.4	48.2	0.2
4 years	49.8	49.8	0.0	50.3	50.2	0.1
5 years	51.6	51.6	0.0	50.8	50.7	0.1

Table 2-1-2-13 Comparison of 2020 and 2015 results on average hip circumference in young children aged 3~5 (cm)

Age group	Boys			Girls		
	2020	2015	Difference	2020	2015	Difference
3 years	54.7	52.4	2.3*	55.2	52.7	2.5*
4 years	57.3	55.1	2.2*	58.7	55.2	3.5*
5 years	59.3	57.7	1.6*	60.1	57.7	2.4*

2.1.4 Width Indicators

Compared with the results in 2015, the average shoulder width of young children increased by 0.4~0.7cm in each age group in 2020. Significant difference was found in each age group ($P < 0.05$) (Table 2-1-2-14).

Compared with the results in 2015, the average pelvis width of young children increased by 1.1~1.3cm in each age group in 2020. Significant difference was found in each age group ($P < 0.05$) (Table 2-1-2-15).

Table 2-1-2-14 Comparison of 2020 and 2015 results on average shoulder width in young children aged 3~5 (cm)

Age group	Boys			Girls		
	2020	2015	Difference	2020	2015	Difference
3 years	22.3	21.6	0.7*	22.4	21.9	0.5*
4 years	23.4	23.0	0.4*	23.5	23.0	0.5*
5 years	24.7	24.1	0.6*	24.8	24.1	0.7*

Table 2-1-2-15 Comparison of 2020 and 2015 results on average pelvis width in young children aged 3~5 (cm)

Age group	Boys			Girls		
	2020	2015	Difference	2020	2015	Difference
3 years	17.0	15.9	1.1*	17.1	16.0	1.1*
4 years	17.7	16.5	1.2*	17.8	16.6	1.2*
5 years	18.6	17.3	1.3*	18.8	17.5	1.3*

2.2 Comparison of Physiological Function

The results of two studies revealed that the average resting heart rate of young children aged 3~5 was obviously higher in 2020 than in 2015, with significant difference found in each age group ($P < 0.05$). The average resting heart rate of boys and girls increased by 6.3~8.0bpm and 3.5~6.9bpm, respectively (Table 2-1-2-16).

Table 2-1-2-16 Comparison of 2020 and 2015 results on average resting heart rate in young children aged 3~5 (bpm)

Age group	Boys			Girls		
	2020	2015	Difference	2020	2015	Difference
3 years	101.3	93.5	7.8*	100.5	97.0	3.5*
4 years	98.1	90.1	8.0*	99.3	93.6	5.7*
5 years	95.4	89.1	6.3*	97.3	90.4	6.9*

2.3 Comparison of Physical Fitness

2.3.1 Speed and Agility

The results of the two studies showed that the average time for 10m shuttle run for boys aged 4~5 and girls aged 3 and 5 increased by 0.2~0.4 second, with significant difference found in boys aged 4~5 and girls aged 5 ($P<0.05$). It indicated that speed of young children was declined (Table 2-1-2-17).

Compared with the results in 2015, the average time for successive jumps with both feet in young children aged 3~4 decreased by 0.2~0.9 second, whereas that of aged 5 boys remained unchanged and that of aged 5 girls increased by 0.3 second. Statistically significant difference was found among aged 3 boys and aged 4 girls ($P<0.05$). It revealed that agility of young children was improved (Table 2-1-2-18).

Table 2-1-2-17 Comparison of 2020 and 2015 results on average time of 10m shuttle run in young children aged 3~5 (sec)

Age group	Boys			Girls		
	2020	2015	Difference	2020	2015	Difference
3 years	9.8	9.8	0.0	10.1	9.9	0.2
4 years	8.2	7.8	0.4*	8.2	8.2	0.0
5 years	7.2	6.9	0.3*	7.4	7.1	0.3*

Table 2-1-2-18 Comparison of 2020 and 2015 results on average time of successive jumps with both feet in young children aged 3~5 (sec)

Age group	Boys			Girls		
	2020	2015	Difference	2020	2015	Difference
3 years	12.9	13.7	-0.8*	12.5	13.2	-0.7
4 years	8.9	9.1	-0.2	8.2	9.1	-0.9*
5 years	6.9	6.9	0.0	7.0	6.7	0.3

2.3.2 Strength

Comparison of the results in the two studies showed that the average distance of standing long jump of boys aged 3~4 and girls aged 3 decreased by 0.6~4.3cm in 2020, while that of boys aged 5 increased by 1.0cm. The average distance of standing long jump for girls aged 4~5 increased by 0.1~3.4cm. Statistically significant difference was found in boys aged 3 and girls aged 5 ($P<0.05$). It indicated that lower limb strength was declined in boys while improved in girls (Table 2-1-2-19).

Compared with the results in 2015, the average distance of tennis ball distance throw in 2020 decreased by 0.1~0.2m in boys of each age group, and remained unchanged in girls. Statistically significant difference was found in the aged 3~4 groups of boys ($P<0.05$). It indicated that upper limb strength somewhat was declined in boys while varied little in girls (Table 2-1-2-20).

Table 2-1-2-19 Comparison of 2020 and 2015 results on average distance of standing long jump in young children aged 3~5 (cm)

Age group	Boys			Girls		
	2020	2015	Difference	2020	2015	Difference
3 years	50.0	54.3	-4.3*	49.3	49.9	-0.6
4 years	76.6	77.6	-1.0	75.5	75.4	0.1
5 years	95.1	94.1	1.0	91.0	87.6	3.4*

Table 2-1-2-20 Comparison of 2020 and 2015 results on average distance of tennis ball distance throw in young children aged 3~5 (m)

Age group	Boys			Girls		
	2020	2015	Difference	2020	2015	Difference
3 years	2.5	2.7	-0.2*	2.2	2.2	0.0
4 years	3.8	4.0	-0.2*	3.3	3.3	0.0
5 years	5.1	5.2	-0.1	4.2	4.2	0.0

2.3.3 Flexibility

The results of the two studies showed that the average distance of sit and reach of young children fluctuated irregularly in each age group. The average distance of sit and reach of boys aged 4 and girls aged 3~4 increased by 0.7~2.6cm in 2020. The average sit and reach of boys aged 3 and 5 decreased by 0.6cm and 0.3cm, respectively, and that of girls aged 5 decreased by 0.5cm. Significant difference was found in boys and girls aged 3~4 ($P < 0.05$) (Table 2-1-2-21).

Table 2-1-2-21 Comparison of 2020 and 2015 results on average distance of sit and reach in young children aged 3~5 (cm)

Age group	Boys			Girls		
	2020	2015	Difference	2020	2015	Difference
3 years	9.6	10.2	-0.6*	11.1	10.4	0.7*
4 years	9.0	7.8	1.2*	11.5	8.9	2.6*
5 years	7.3	7.6	-0.3	9.5	10.0	-0.5

2.3.4 Balance

Compared with the results in 2015, the average time to finish walking on balance beam for boys aged 3, 4 and 5 increased by 2.3 seconds, 1.4 seconds and 1.2 seconds, respectively, with significant difference found ($P < 0.05$). The average time to finish walking on balance beam for girls decreased by 0.7 second at age 3, while it remained stable at age 4 and increased by 1.1 seconds at age 5, with no statistically significant difference found in each age group. It indicated that balance of girls was somewhat declined (Table 2-1-2-22).

Table 2-1-2-22 Comparison of 2020 and 2015 results on average time to finish walking on balance beam in young children aged 3~5 (sec)

Age group	Boys			Girls		
	2020	2015	Difference	2020	2015	Difference
3 years	24.4	22.1	2.3*	21.8	22.5	-0.7
4 years	14.0	12.6	1.4*	12.8	12.8	0.0
5 years	8.8	7.6	1.2*	10.5	9.4	1.1

2.4 Comparison of Teeth

2.4.1 Occurrence of Decayed Primary Teeth

The results of the two studies showed that the prevalence of decayed primary teeth decreased in each age group in 2020 compared with that in 2015. Significant difference was observed in each age group except the aged 4 group of boys ($P < 0.05$). In the 2020 study, the prevalence of decayed primary teeth was ranged from 25.4%~44.3% for boys and 25.9%~39.5% for girls; while this prevalence in the 2015 study was ranged from 42.2%~62.0% for boys and 37.5%~56.3% for girls (Table 2-1-2-23).

Table 2-1-2-23 Comparison of 2020 and 2015 results on prevalence of decayed primary teeth in young children aged 3~5 (%)

Age group	Boys			Girls		
	2020	2015	Difference	2020	2015	Difference
3 years	25.4	42.2	-16.8*	25.9	37.5	-11.6*
4 years	44.3	47.8	-3.5	39.5	52.7	-13.2*
5 years	40.4	62.0	-21.6*	39.4	56.3	-16.9*

Compared with the results in 2015, the prevalence of filled primary teeth in 2020 decreased in both boys and girls at age 3 and girls at age 5, while increased in other age groups. In the 2020 study, the prevalence of filled primary teeth was ranged from 1.3%~14.9% for boys and 8.3%~13.0% for girls; while this prevalence in the 2015 study was ranged from 2.9%~13.1% for boys and 1.6%~12.0% for girls. Comparison of the two studies indicated that no significant difference was observed in all age groups except the aged 4 group of girls ($P < 0.05$) (Table 2-1-2-24).

Table 2-1-2-24 Comparison of 2020 and 2015 results on prevalence of filled primary teeth in young children aged 3~5 (%)

Age group	Boys			Girls		
	2020	2015	Difference	2020	2015	Difference
3 years	1.3	2.9	-1.6	0.0	1.6	-1.6
4 years	8.2	7.8	0.4	13.0	3.8	9.2*
5 years	14.9	13.1	1.8	8.3	12.0	-3.7

The results of the two studies showed that the prevalence of missing primary teeth in 2020 reached a peak of 2.2% in boys aged 4, and gradually increased with advancing age in girls. In the 2020 study, the prevalence of missing primary teeth was ranged from 0.5%~2.2% for boys and 1.6%~2.6% for girls. In the 2015 study, the prevalence of missing primary teeth occurred at age 5 for boys (0.9%) and at age 3 for girls (0.8%). Compared with the results in 2015, the prevalence of missing primary teeth in 2020 decreased in boys aged 5 and girls aged 3, while increased in other age groups. However, no significant difference was observed in all age groups except a significant increase observed in boys aged 4 ($P < 0.05$) (Table 2-1-2-25).

Table 2-1-2-25 Comparison of 2020 and 2015 results on prevalence of missing primary teeth in young children aged 3~5 (%)

Age group	Boys			Girls		
	2020	2015	Difference	2020	2015	Difference
3 years	0.9	0.0	0.9	0.0	0.8	-0.8
4 years	2.2	0.0	2.2*	1.6	0.0	1.6
5 years	0.5	0.9	-0.4	2.6	0.7	1.9

The study results showed that the prevalence of decayed-missing-filled primary teeth in 2015 and 2020 tended to increase significantly with advancing age, except in the aged 4 group of girls in 2020. The highest prevalence of decayed-missing-filled primary teeth was 48.7% as recorded in boys aged 5 in 2020. The prevalence of decayed-missing-filled primary teeth was lower in 2020 than in 2015 in each age group. Significant difference was observed in all age groups except the aged 4 groups of boys and girls ($P < 0.05$). In the 2020 study, the prevalence of decayed-missing-filled primary teeth was ranged from 26.3%~48.7% for boys and 25.9%~44.2% for girls, while that in the 2015 study was ranged from 42.7%~63.3% for boys and 37.5%~59.9% for girls (Table 2-1-2-26).

Table 2-1-2-26 Comparison of 2020 and 2015 results on prevalence of decayed-missing-filled primary teeth in young children aged 3~5 (%)

Age group	Boys			Girls		
	2020	2015	Difference	2020	2015	Difference
3 years	26.3	42.7	-16.4*	25.9	37.5	-11.6*
4 years	45.3	48.9	-3.6	44.2	53.4	-9.2
5 years	48.7	63.3	-14.6*	41.2	59.9	-18.7*

2.4.2 Occurrence of Decayed Permanent Teeth

In the two studies, the prevalence of decayed permanent teeth appeared at age 5 for both boys and girls, with 0.9% for boys and 0.6% for girls in 2020 and 0.5% for boys and 0.7% for girls in 2015. The prevalence of decayed permanent teeth of boys was higher in 2020 than in 2015, while this prevalence of was found lower in girls in 2020. However, no significant difference was observed (Table 2-1-2-27).

Table 2-1-2-27 Comparison of 2020 and 2015 results on prevalence of decayed permanent teeth in young children aged 3~5 (%)

Age group	Boys			Girls		
	2020	2015	Difference	2020	2015	Difference
3 years	0.0	0.0	0.0	0.0	0.0	0.0
4 years	0.0	0.0	0.0	0.0	0.0	0.0
5 years	0.9	0.5	0.4	0.6	0.7	-0.1

The results of the two studies showed that the prevalence of filled permanent teeth appeared at age 5 for boys in 2020, which was decreased by 0.1% than that in 2015, with no significant difference found. The prevalence of filled permanent teeth was not observed in girls in 2020 (Table 2-1-2-28).

Table 2-1-2-28 Comparison of 2020 and 2015 results on prevalence of filled permanent teeth in young children aged 3~5 (%)

Age group	Boys			Girls		
	2020	2015	Difference	2020	2015	Difference
3 years	0.0	0.0	0.0	0.0	0.0	0.0
4 years	0.0	0.0	0.0	0.0	0.0	0.0
5 years	0.4	0.5	-0.1	0.0	0.7	-0.7

The results of the two studies showed that the prevalence of missing permanent teeth in 2020 appeared at age 5 for both boys and girls, with an incidence rate of 0.4% and 0.6% for boys and girls, respectively. Both boys and girls aged 5 had a higher prevalence of missing permanent teeth in 2020 than in 2015, with no significant difference found (Table 2-1-2-29).

Table 2-1-2-29 Comparison of 2020 and 2015 results on prevalence of missing permanent teeth in young children aged 3~5 (%)

Age group	Boys			Girls		
	2020	2015	Difference	2020	2015	Difference
3 years	0.0	0.0	0.0	0.0	0.0	0.0
4 years	0.0	0.0	0.0	0.0	0.0	0.0
5 years	0.4	0.0	0.4	0.6	0.0	0.6

The results of the two studies showed that the prevalence of decayed-missing-filled permanent teeth in 2020 appeared at age 5 for both boys and girls, with an incidence rate of 0.9% and 0.6% for boys and girls, respectively. The prevalence of decayed-missing-filled permanent teeth of boys was 0.4% higher than that in 2015, while that of girls was 0.1% lower than that in 2015, with no significant difference found (Table 2-1-2-30).

Table 2-1-2-30 Comparison of 2020 and 2015 results on prevalence of decayed-missing-filled permanent teeth in young children aged 3~5 (%)

Age group	Boys			Girls		
	2020	2015	Difference	2020	2015	Difference
3 years	0.0	0.0	0.0	0.0	0.0	0.0
4 years	0.0	0.0	0.0	0.0	0.0	0.0
5 years	0.9	0.5	0.4	0.6	0.7	-0.1

(III) Summary

1. Summary of 2020 Results on Physical Fitness Study of Young Children

1.1 Feeding Patterns and Living Habits

Our study indicated that the majority of young children were born full-term, and 40.6% of them were breast-fed within four months after birth. Most of the young children slept for more than 8 hours daily and about 1/5 of them had more than 10 hours of sleep; around half of the young children spent 30 minutes to 1 hour daily on watching TV, video and playing video games; 11.3% of young children spent more than 2 hours daily on electronic devices in a typical week; most of the young children brushed their teeth every day, but only a few used dental floss in addition to tooth brushing, and about 1/4 of them have been to dental clinics for dental examination within the past 12 months.

1.2 Physical Exercise

According to the study of physical exercises of young children, the top five physical exercises with highest participation in 2020 were walking & running, cycling, swimming, sports games and dancing. Walking & running and cycling had the highest participation in boys, while walking & running and dancing had the highest participation in girls.

In respect of exercise time, the average time young children spent on physical exercise on rest days was significantly higher than that on school days in 2020; the proportion of young children spending 2 hours or more on daily exercising accounted for 6.8% on rest days and 22.6% on school days.

1.3 Anthropometric Measurements

Our study indicated that the anthropometric indicators of young children tended to increase with advancing age, reflecting obvious age characteristics. The height and weight indicators increased at a similar rate, while the rate of increase in waist circumference was slower than that in hip circumference which meant that their WHR declined gradually with advancing age.

1.4 Physiological Function and Physical Fitness

As age increased, the resting heart rate of young children decreased, whereas their physiological function tended to improve.

The physical fitness indicators of young children including speed and agility, strength and balance ability improved with advancing age. By contrast, girls were more flexible than boys, while boys had apparently better speed and strength than girls. No significant difference between gender was found in the balance ability and agility.

1.5 Teeth

Our study showed that the prevalence of decayed primary teeth peaked in young children aged 4, and a gradual increase was observed among young children with advancing age in the prevalence of filled, missing and decayed-missing-filled primary teeth.

2. Comparison of 2020 and 2015 Physical Fitness Study Results of Young Children

Through the comparison of the 2020 and 2015 questionnaire survey, the proportion of young children who were breast-fed and mixed-fed increased in 2020, and the proportion of breast feeding increased by 17.2% in 2020. In respect of the average daily time spent on electronic devices in young children in 2020, the proportion of young children spending more than 2 hours daily using electronic devices on rest days was 11.4% higher than that on school days, and 11.3% of them spent more than 2 hours daily on electronic devices in a typical week. Comparing to the results in 2015, it showed a decrease of 1.7% in 2020. Besides, young children spent less time on watching TV, video and playing video games and the top four physical exercises among young children with the highest participation rate were cycling, swimming, ball games and dancing in the two studies.

According to the 2020 and 2015 studies, the anthropometric indicators of young children increased with advancing age, reflecting the principle of natural growth. In comparing the results of the 2020 and 2015 studies, the average chest circumference, hip circumference, shoulder width, pelvis width among boys and girls, as well as the sitting height and waist circumference of girls were all found to be higher in 2020, while other indicators remained basically stable or tended to decline slightly.

The average resting heart rate of young children improved in 2020 compared with that in 2015, indicating a reduced physiological function level.

Compared with the results in 2015, the physical fitness trend of young children varied differently in 2020, which was reflected by the fact that the score of 10m shuttle run, which was used to reflect speed and agility, decreased, whereas the average time for successive jumps with both feet was improved; tennis ball distance throw and standing long jump were used to reflect strength, in which tennis ball distance throw was found to be worsen in boys while varied little in girls, and standing long jump was declined in boys while improved in girls; Balance ability was declined in boys while slightly improved in aged 3 girls and declined in aged 5 girls comparing to 2015; whereas flexibility fluctuated irregularly in each age group.

Compared with the results in 2015, the incidence rate of decayed primary teeth in 2020 peaked at age 4 for both boys and girls, which accounted for 44.3% and 39.5%, respectively. In general, both boys and girls had a lower prevalence of decayed primary teeth in 2020 than in 2015, and the prevalence of decayed-missing-filled primary teeth was also lower for boys and girls in 2020 than in 2015. Comparison of the two studies showed that the regularity of difference between gender was not significant in the prevalence of missing and filled primary teeth. In 2020, the prevalence of decayed, filled, missing and DMF permanent teeth of boys and girls all occurred at age 5. In 2020, both boys and girls had a higher prevalence of missing permanent teeth but a lower prevalence of filled permanent teeth compared with the results in 2015. Additionally, the prevalence of decayed and DMF permanent teeth in 2020 increased in boys while decreased in girls, with no significant difference observed.

II. Children and Adolescents (Students)

(I) Physical Fitness Conditions of Children and Adolescents (Students) in 2020

1. Basic Information of the Subjects

Primary and secondary students were divided into two categories according to gender, and further classified into 26 age groups which differed by one year. University students were divided into two categories according to gender, and further divided into 8 age groups which differed by one year.

In the primary and secondary student category, 1,641 subjects (909 males and 732 females) were drawn randomly from Keang Peng School (primary and secondary school sections), and Hou Kong Middle School (including its affiliated primary school) in the northern area (Nossa Senhora de Fátima). In the central area (Santo António and São Lázaro), 1,541 subjects (845 males and 696 females) were drawn from Pui Ching Middle School, Colegio Dom Bosco (Yuet Wah) Chinese Section, Yuet Wah College (Chinese Section) and Sacred Heart Canossian College. In the southern area (Sé Catedral and São Lourenço), 1,371 subjects (779 males and 592 females) were drawn from Pooi To Middle School (including Taipa Primary Branch, branch school of Praia Grande and primary school section) and Estrela do Mar School (including branch school).

In the university student category, 783 subjects (383 males and 400 females) were drawn from the University of Macau, Macao University of Science and Technology, Macao Polytechnic Institute, Kiang Wu Nursing College of Macao, Institute for Tourism Studies and other universities or tertiary institutions.

The distribution of subjects and sampling sites is shown in Table 3-2-1-1. The residential distribution of student subjects (%) is shown in Table 3-2-1-2 and the sample size in each age group is shown in Table 2-2-1-1.

Table 2-2-1-1 Sample size in each age group

Age group (years)	6	7	8	9	10	11	12	13	14	15	16	17	18	19	20	21	22	Total
Male	238	238	257	188	199	180	208	200	186	169	174	184	163	127	106	58	41	2916
Female	171	172	157	160	142	151	185	155	151	152	158	200	156	117	97	63	32	2419
Subtotal	409	410	414	348	341	331	393	355	337	321	332	384	319	244	203	121	73	5335

In this study, the majority of children and adolescents were born in Macao, followed by Mainland China and Hong Kong, with similar proportion of males and females. However, the proportion of gender differed in each age group. As age increased, the proportion of students born in Macao declined dramatically from 90.5% males and 87.4% females in primary schools to 52.7% males and 50.6% females in universities. Whereas the proportion of students born in Mainland China increased tremendously from 5.4% males and 7.3% females in primary schools to 42.8% males and 44.2% females in universities (Table 3-2-1-3).

2. Lifestyle

In the category of children and adolescents (students aged 6~22), the study on lifestyle of students covered 8 areas, namely, living habits, physical education at school, extracurricular physical exercises, major physical exercises, strength training, occurrence of diseases, dental hygiene and health literacy, which were examined as follows:

2.1 Living Habits

Three areas on living habits of student subjects were examined: average daily accumulated time spent on electronic devices, average daily sleep time (including naps) and transportation means.

2.1.1 Analysis of Electronic Device Use

(1) Use of electronic devices in primary students: among children and adolescents (primary students), male students who spent an average daily accumulated time of 30 minutes to 1 hour on electronic devices on school days accounted for 27.4%, followed by 1~2 hours (22.6%), less than 30 minutes (21.4%), 2 hours or more (17.7%), and those who basically didn't use (10.9%); female students who spent an average daily accumulated time of 30 minutes to 1 hour on electronic devices on school days accounted for 30.1%, followed by less than 30 minutes (21.4%), 1~2 hours (21.2%), 2 hours or more (17.4%), and those who basically didn't use (10.0%). On rest days, male students who spent an average daily accumulated time of 2 hours or more on electronic devices exhibited the highest proportion of 50.8%, followed by 1~2 hours (28.1%), 30 minutes to 1 hour (15.2%), less than 30 minutes (4.9%), and those who basically didn't use (1.0%); while female students who spent an average daily accumulated time of 2 hours or more on electronic devices had the highest proportion of 45.5%, followed by 1~2 hours (28.6%), 30 minutes to 1 hour (16.2%), less than 30 minutes (7.4%), and those who basically didn't use (2.2%). The study results indicated that primary students spent more time on TV and electronic devices on rest days than on school days. In a typical week, 27.1% of male students and 25.4% of female students spent an average accumulated time of 2 hours or more on electronic devices, with no significant difference found between gender (Figures 2-2-1-1 and 2-2-1-2, Tables 3-2-2-1 and 3-2-2-2).

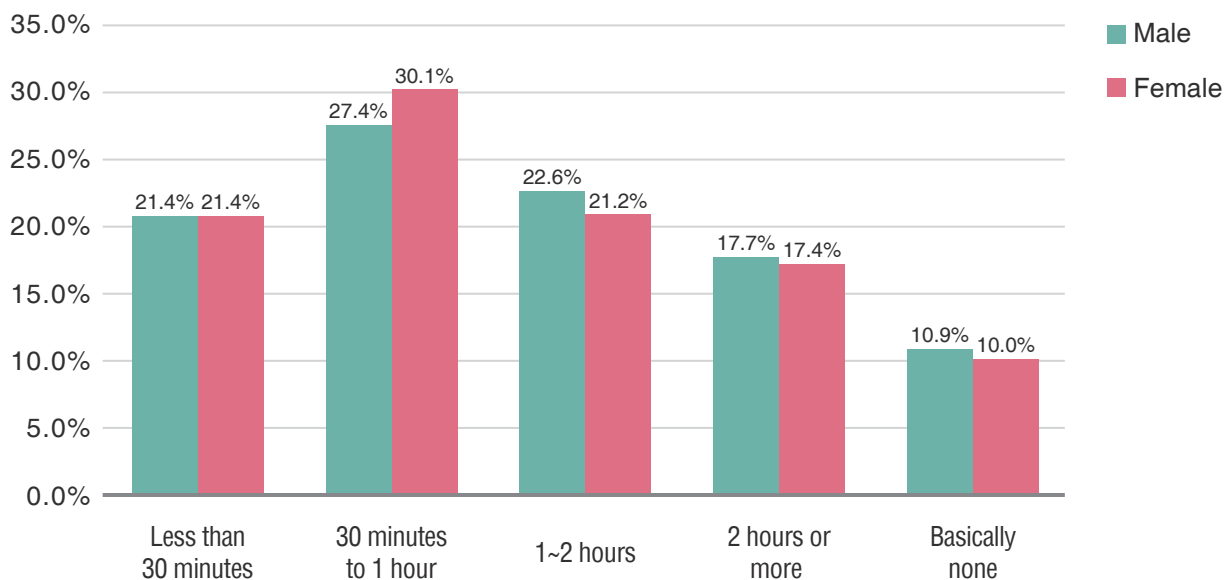

Figure 2-2-1-1 Average daily accumulated time spent on electronic devices on school days in primary students

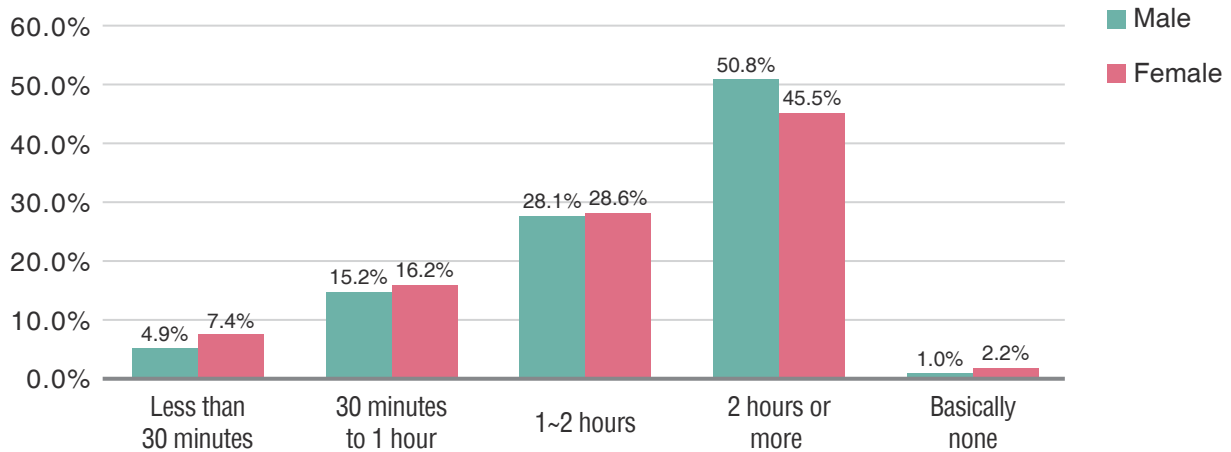

Figure 2-2-1-2 Average daily accumulated time spent on electronic devices on rest days in primary students

(2) Electronic device use in secondary students: among children and adolescents (secondary students), male students who spent an average daily accumulated time of 2 hours or more on electronic devices on school days accounted for the highest proportion of 64.8%, followed by 1~2 hours (22.2%), 30 minutes to 1 hour (7.7%), less than 30 minutes (3.4%), and those who basically didn't use (1.9%); female students who spent an average daily accumulated time of 2 hours or more on electronic devices on school days accounted for the highest proportion of 71.7%, followed by 1~2 hours (18.1%), 30 minutes to 1 hour (6.6%), less than 30 minutes (3.3%), and those who basically didn't use (0.3%). On rest days, male students who spent an average daily accumulated time of 2 hours or more on electronic devices also exhibited the highest proportion of 87.2%, followed by 1~2 hours (9.4%), 30 minutes to 1 hour (1.7%), those who basically didn't use (1.1%), and less than 30 minutes (0.7%); while female students who spent an average daily accumulated time of 2 hours or more on electronic devices had the highest proportion of 89.0%, followed by 1~2 hours (8.2%), 30 minutes to 1 hour (2.1%), less than 30 minutes (0.5%), and those who basically didn't use (0.2%). The study results indicated that watching TV and using electronic devices occupied a great amount of time in secondary students, and the average daily accumulated time of such use was much higher on rest days than on school days. In a typical week, 71.2% of male students and 76.6% of female students spent an average accumulated time of 2 hours or more on electronic devices, reflecting that female students exhibited a significantly higher proportion than male students in spending 2 hours or more on electronic devices ($P < 0.05$) (Figures 2-2-1-3 and 2-2-1-4, Tables 3-2-2-1 and 3-2-2-2).

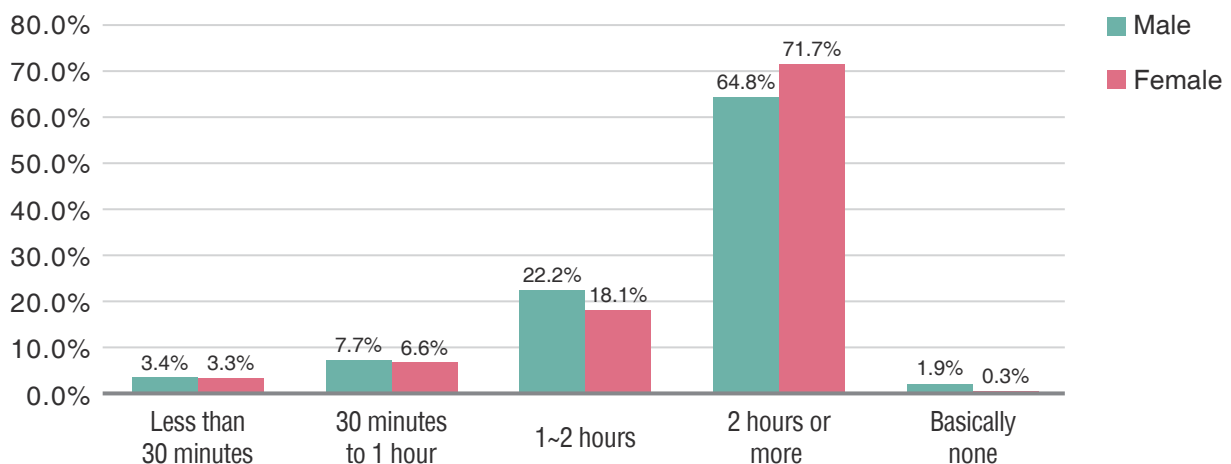

Figure 2-2-1-3 Average daily accumulated time spent on electronic devices on school days in secondary students

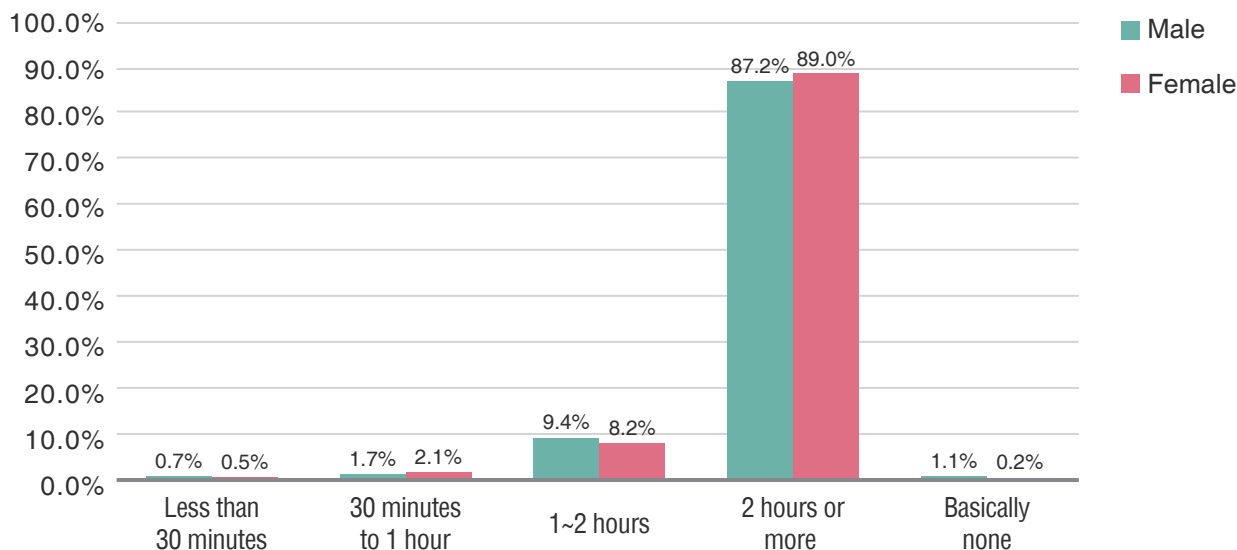

Figure 2-2-1-4 Average daily accumulated time spent on electronic devices on rest days in secondary students

2.1.2 Analysis of Sleep Time

(1) According to the study of sleep status of primary students, 78.8% of children and adolescents (primary students) slept an average of 8~10 hours daily (including naps) on school days, while 12.3% of them slept less than 8 hours daily, and 8.9% of them slept 10 hours or more daily. On rest days, 59.2% of primary students slept an average of 8~10 hours daily (including naps), while 6.4% of them slept less than 8 hours daily, and 34.4% of them slept 10 hours or more daily. Children and adolescents (primary students) had a higher proportion of an average sleep time of 8~10 hours and less than 8 hours on school days than on rest days, with significant difference observed ($P < 0.05$). Whereas the proportion of those slept an average of 10 hours or more daily was lower on school days than on rest days, and the difference was significant ($P < 0.05$) (Figure 2-2-1-5, Tables 3-2-2-3 to 3-2-2-6).

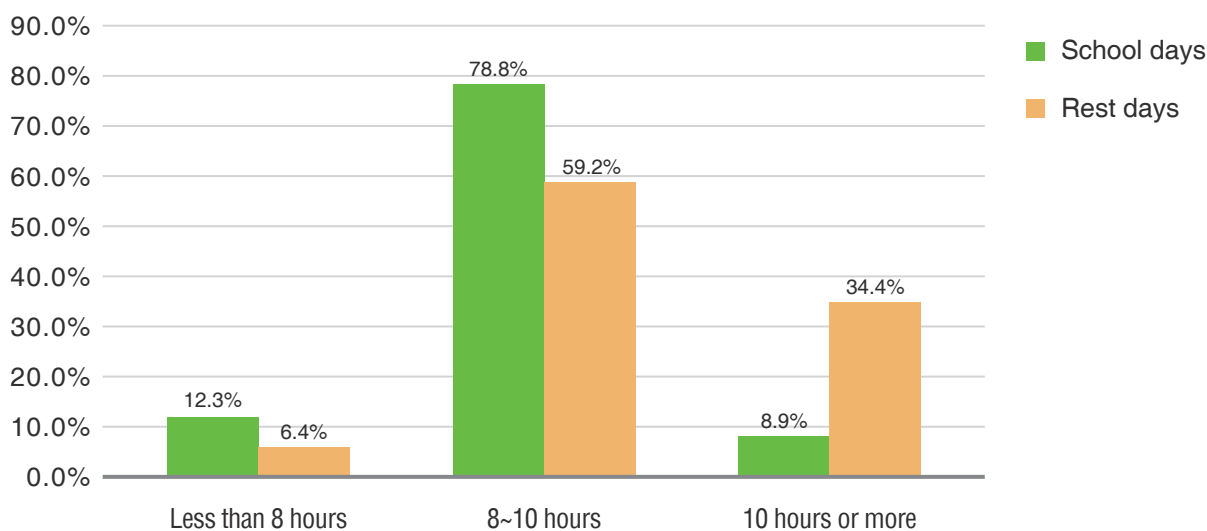

Figure 2-2-1-5 Average sleep time (including naps) in primary students

(2) According to the study of sleep status of secondary students, children and adolescents (secondary students) slept less than 8 hours daily (including naps) on school days contributed to the highest proportion of 58.8%, while 37.4% of them slept an average of 8~10 hours daily, and 3.8% had an average of 10 hours or more of sleep daily. On rest days, secondary students slept an average of 8~10 hours daily had the highest proportion of 53.0%, while 13.5% of them slept less than 8 hours daily, and 33.5% of them had an average of 10 hours or more of sleep daily. Children and adolescents (secondary students) exhibited a higher proportion of an average sleep time of less than 8 hours and a lower proportion of an average sleep time of 8~10 hours and 10 hours or more on school days than on rest days, with significant difference observed ($P < 0.05$). In a typical week, 40.5% of male students and 52.0% of female students had an average daily sleep time of less than 8 hours (including naps), which showed a higher proportion in female students, indicating that female students had less daily sleep time than male students and significant difference was observed ($P < 0.05$) (Figures 2-2-1-6 and 2-2-1-7, Tables 3-2-2-3 to 3-2-2-6).

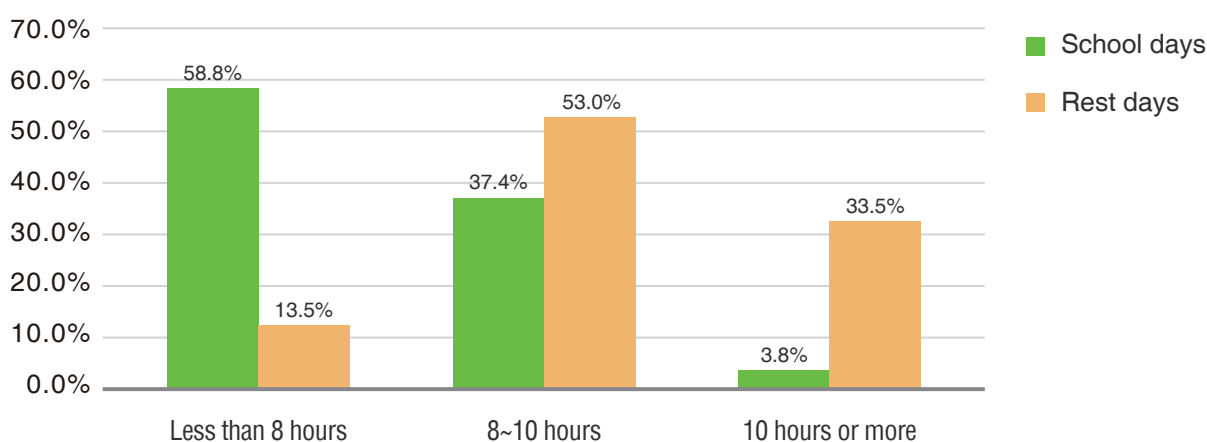

Figure 2-2-1-6 Average sleep time (including naps) in secondary students

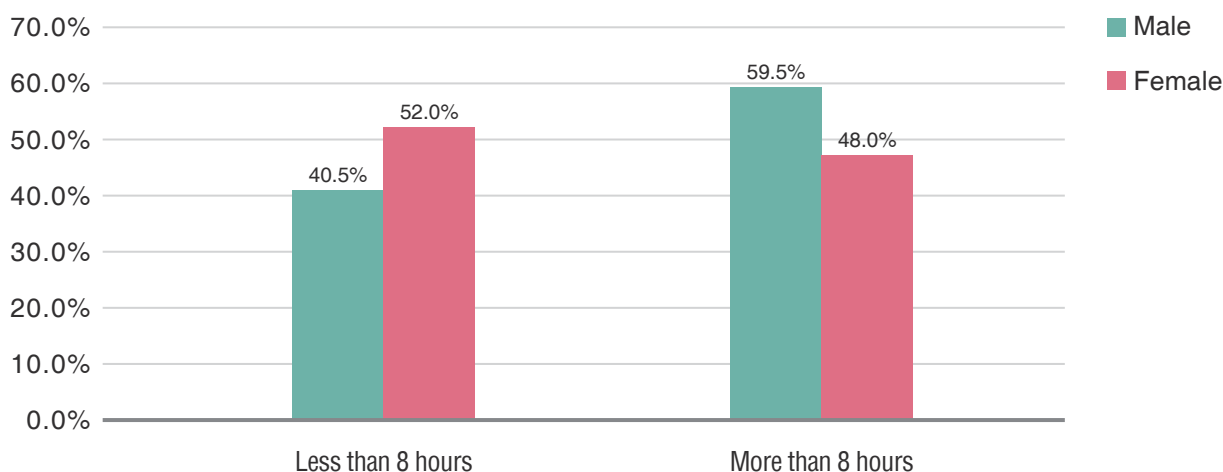

Figure 2-2-1-7 Average sleep time (including naps) in secondary students by gender

(3) According to the study of sleep status of university students, 39.5% of children and adolescents (university students) slept an average of 8~10 hours daily (including naps), while 54.6% of them slept less than 8 hours daily (including naps), and 5.9% of them had an average of 10 hours or more of sleep daily (including naps). Among children and adolescents (university students), a lower proportion of males had an average of less than 8 hours of sleep (including naps) than females, and the difference was significant ($P < 0.05$) (Figure 2-2-1-8, Tables 3-2-2-3 and 3-2-2-4).

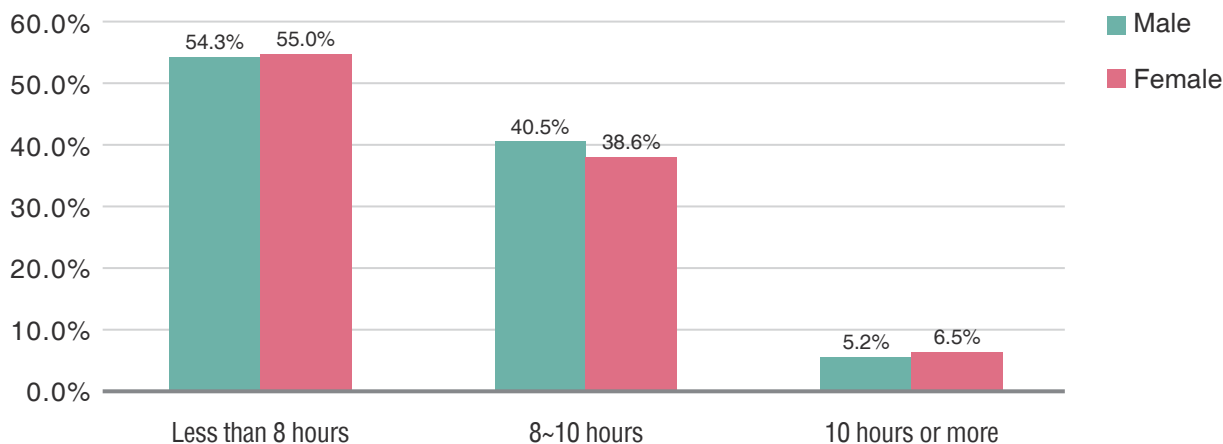

Figure 2-2-1-8 Average sleep time (including naps) in university students

2.1.3 Transportation Means

Our study showed that, 49.6% of children and adolescents (university students) commuted mainly on foot; 36.1% of them preferred commuting by public transport, private car or motorcycle; 8.3% chose to motorcycle; 5.0% chose to drive; and 0.9% chose to cycle. More female students commuted on foot (52.9%) and by public transport or private car (38.3%) than male students (46.0% on foot, 33.9% by public transport or private car), whereas more male students chose to motorcycle (12.0%) and drive (6.5%) than female students (4.8% motorcycling, 3.5% driving). Significant difference was found between gender in the major transportation means of motorcycling ($P < 0.05$), while no significant difference between gender was found in other transportation means (Figure 2-2-1-9).

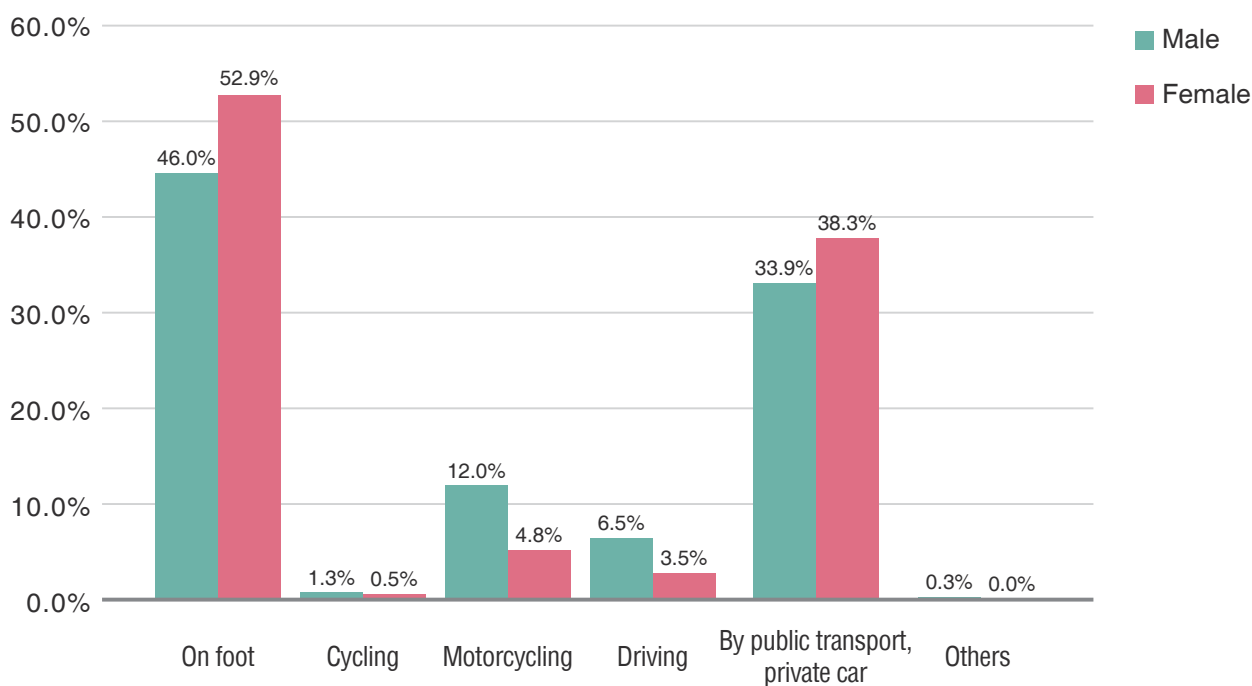

Figure 2-2-1-9 Major transportation means in university students

2.2 Physical Education at School

Information regarding physical education (PE) classes at school was examined, which comprised weekly frequency of PE classes, average duration of each PE class, and self-perception of exercise intensity of PE classes.

(1) Among primary students, the proportion of subjects who had two, one, and none PE class(es) weekly accounted for 69.0%, 30.5% and 0.5%, respectively. Among students attending PE classes, those who took PE classes lasting for 30 minutes to 1 hour (1 session) accounted for a higher proportion of 70.3%, and PE classes lasting for 1~1.5 hours (2 consecutive sessions) accounted for a lower proportion of 29.7%. During PE classes, male students who reached low, moderate and high exercise intensity were 16.0%, 64.9% and 19.1%, respectively, while female students who reached low, moderate and high exercise intensity were 17.3%, 71.2% and 11.5%, respectively. Compared with female students, male students had a lower proportion in reaching moderate exercise intensity, but a higher proportion in reaching high exercise intensity during PE classes, with significant difference observed ($P < 0.05$). However, no significant difference between gender was observed in reaching low exercise intensity (Figure 2-2-1-10, Tables 3-2-2-7 to 3-2-2-12).

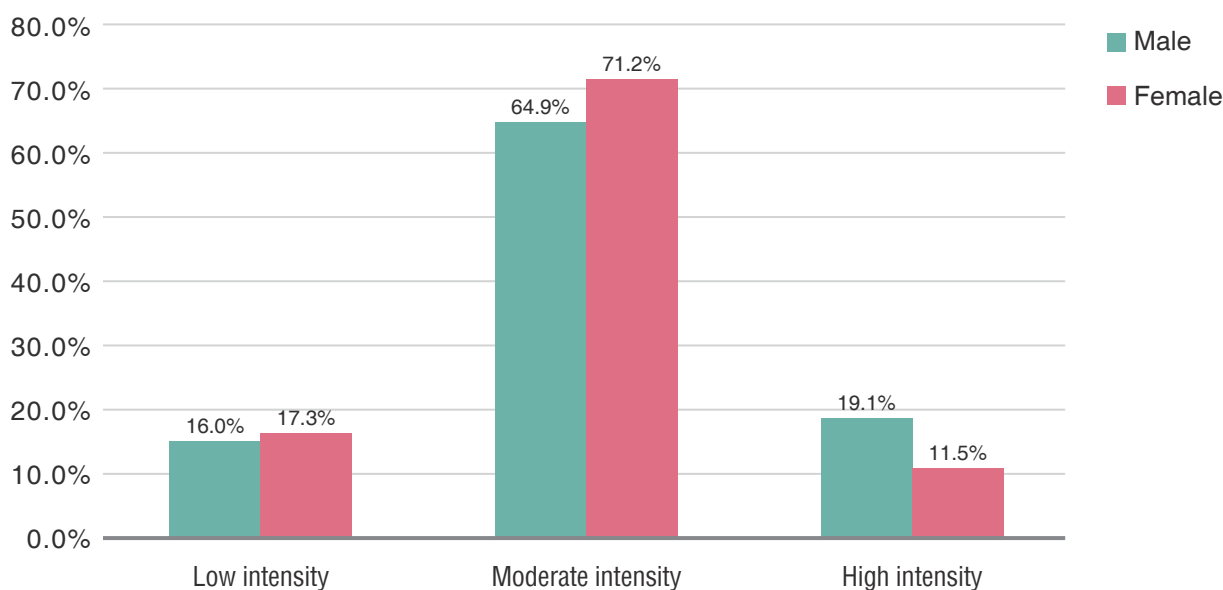

Figure 2-2-1-10 Self-perception of exercise intensity of PE classes in primary students

(2) Among secondary students, the proportion of subjects who had two, one, and none PE class(es) weekly accounted for 39.6%, 59.8% and 0.6%, respectively. Among students attending PE classes, those who took PE classes lasting for 1~1.5 hours (2 consecutive sessions) accounted for a higher proportion of 60.2%, and PE classes lasting for 30 minutes to 1 hour (1 session) accounted for a lower proportion of 39.8%. During PE classes, male students who reached low, moderate and high exercise intensity were 9.1%, 68.4% and 22.5%, respectively, while female students who were able to reach low, moderate and high exercise intensity were 7.0%, 73.6% and 19.4%, respectively. Compared with female students, male students had a lower proportion in reaching moderate exercise intensity, but a higher proportion in reaching high exercise intensity during PE classes, with significant difference observed ($P < 0.05$). However, no significant gender difference was observed in reaching low exercise intensity (Figure 2-2-1-11, Tables 3-2-2-7 to 3-2-2-12).

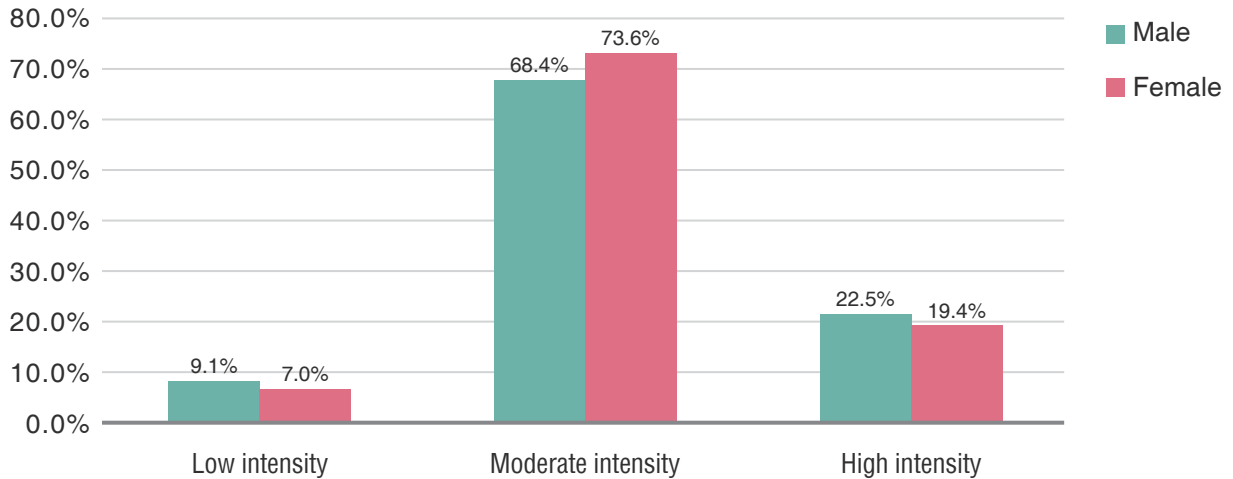

Figure 2-2-1-11 Self-perception of exercise intensity of PE class in secondary students

In terms of comparison of self-perception of exercise intensity of PE classes, primary students exhibited a higher proportion (16.5%) than secondary students (8.1%) in reaching low exercise intensity, but a lower proportion in reaching moderate (67.5%) and high (15.9%) exercise intensity than secondary students (70.8% reaching moderate intensity, 21.0% reaching high intensity), with significant difference observed ($P < 0.05$) (Figure 2-2-1-12).

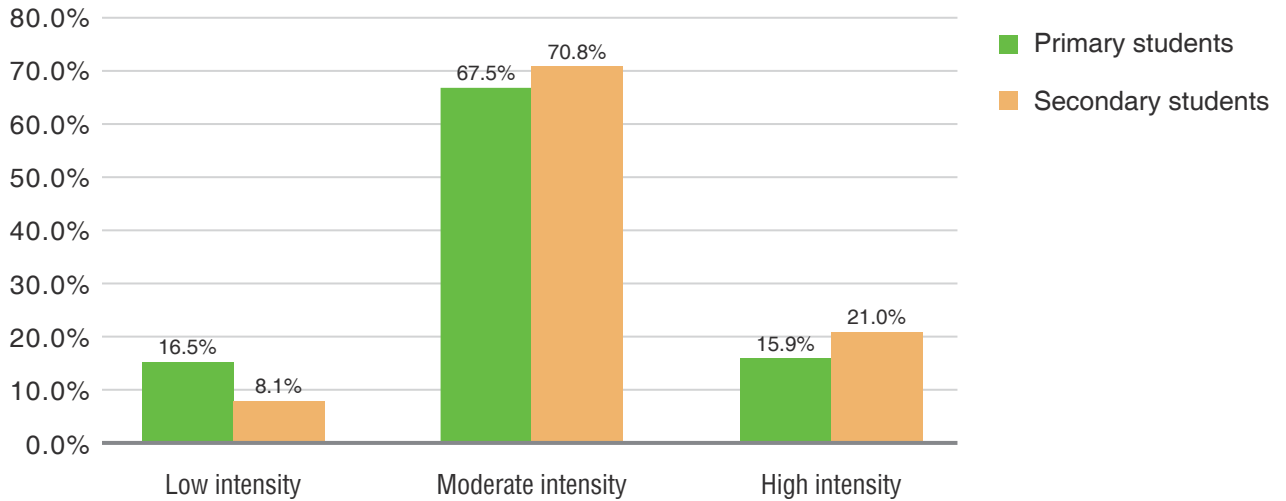

Figure 2-2-1-12 Self-perception of exercise intensity of PE classes in students

2.3 Extracurricular Physical Exercises

Three aspects of extracurricular physical exercises of students were examined, which included weekly frequency of physical exercise, average duration of each exercise, and intensity of each exercise.

2.3.1 Frequency of Physical Exercise

(1) Among primary students, the study results showed that subjects who participated in extracurricular physical exercises 1~2 times a week peaked at 52.5%, followed by 3~4 times (22.1%), no exercises, (15.8%), 5~6 times (6.2%), and 7 times or more (3.3%). In terms of comparison of male and female students, male students

had a lower proportion than female students in no exercises, exercising 1~2 times, and exercising 5~6 times a week, with no significant gender difference. Whereas the proportion of male students who participated in extracurricular physical exercise 7 times or more a week was higher than female students, with significant difference observed ($P<0.05$). No significant difference between gender was found in other exercise frequencies (Figure 2-2-1-13, Tables 3-2-2-13 and 3-2-2-14).

(2) Among secondary students, subjects who participated in extracurricular physical exercise 1~2 times a week peaked at 39.5%, followed by no exercises (26.1%), 3~4 times (21.8%), 5~6 times (9.0%), and 7 times or more (3.6%). In terms of comparison of male and female students, male students had a lower proportion than female students in no exercises and exercising 1~2 times a week; but a higher proportion than female students in exercising 3~4 times, 5~6 times, and 7 times or more a week, with significant difference observed ($P<0.05$) (Figure 2-2-1-13, Tables 3-2-2-13 and 3-2-2-14).

Comparison of frequency of extracurricular physical exercises showed that the proportion of primary students who never participated in extracurricular physical exercises (15.8%) was lower than that of secondary students (26.1%). Primary students also had a lower proportion in the weekly frequency of 5~6 times (6.2%) than secondary students (9.0%), and a higher proportion in the weekly frequency of 1~2 times (52.5%) than secondary students (39.5%), with significant difference observed ($P<0.05$) (Figure 2-2-1-13).

(3) For university students, the study on their physical exercise was not separated into inside or outside school. The study results of physical exercise frequency showed that the proportion of university students doing physical exercises 1~2 times a week reached a peak of 46.4%, followed by 3~4 times (26.6%), once a month or fewer (10.4%), 5~6 times (9.3%), 7 times or more (3.7%), and no exercises (3.6%). Among university students, the non-exercise frequency of male students (3.4%) was lower than that of female students (3.8%), and the proportion of male students exercising less than once a week (9.7%) was lower than that of female students (11.2%), but the difference was not significant. The proportion of male students exercising 1~2 times per week (38.9%) was lower than that of female students (53.6%), and male students had a higher proportion in exercising 3~4 times (30.5%) and 5~6 times per week (12.5%) than female students (22.8% for 3~4 times, 6.3% for 5~6 times), with significant difference found ($P<0.05$). Moreover, male students had a higher proportion (5.0%) than female students (2.5%) in exercising 7 times or more per week, but no significant difference was found (Figure 2-2-1-13, Tables 3-2-2-13 and 3-2-2-14).

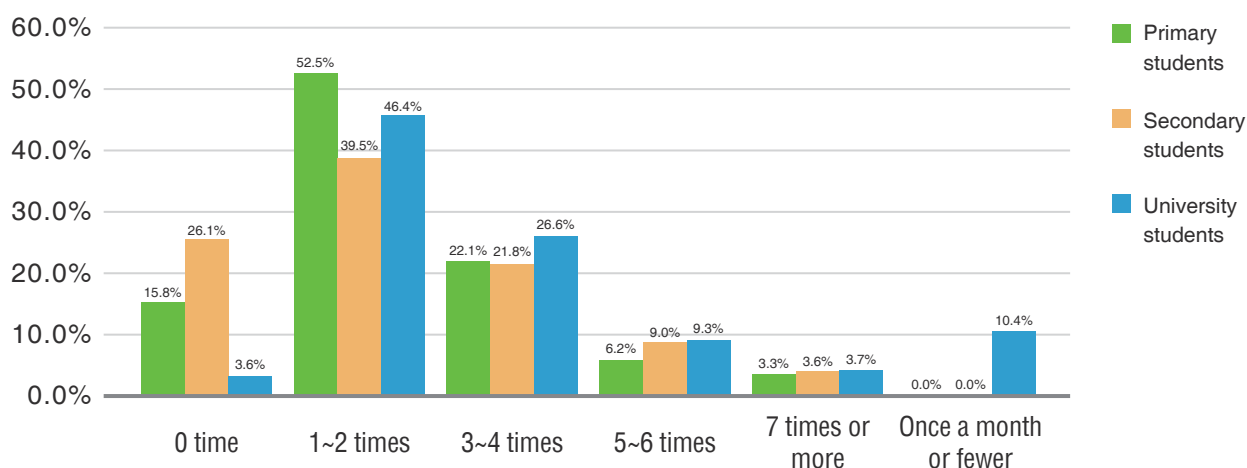

Figure 2-2-1-13 Weekly frequency of extracurricular physical exercises in primary and secondary students and weekly frequency of physical exercises in university students

2.3.2 Average Duration of Each Exercise

(1) Among primary students who participated in physical exercises, subjects exercising for 30 minutes to 1 hour each time accounted for the highest proportion of 45.6%, followed by 1~1.5 hours (26.7%), 1.5 hours or more (16.2%), and less than 30 minutes (11.5%). The proportion of male students exercising for more than 1 hour (47.0%) was higher than that of female students (37.0%), with significant gender difference observed ($P < 0.05$) (Figure 2-2-1-14, Tables 3-2-2-15 and 3-2-2-16).

(2) Among secondary students who participated in physical exercises, subjects exercising for 30 minutes to 1 hour each time contributed to the highest proportion of 35.3%, followed by 1.5 hours or more (23.1%), 1~1.5 hours (21.6%), and less than 30 minutes (20.0%), in which the proportion of male students exercising for more than 1 hour (50.7%) was higher than that of female students (37.4%), with significant gender difference observed ($P < 0.05$) (Figure 2-2-1-14, Tables 3-2-2-15 and 3-2-2-16).

In terms of comparison of average duration of each extracurricular physical exercise, primary students had a lower proportion in exercising for less than 30 minutes and 1.5 hours or more (11.5% and 16.2% respectively) than secondary students (20.0% and 23.1% respectively); but a higher proportion in exercising for 30 minutes to 1 hour and 1~1.5 hours (45.6% and 26.7% respectively) than secondary students (35.3% and 21.6% respectively), with significant difference observed ($P < 0.05$) (Figure 2-2-1-14).

(3) Among university students who participated in physical exercises, those exercising for 1~2 hours each time peaked at 36.1%, followed by 30 minutes to 1 hour (34.5%), less than 30 minutes (18.3%) and 2 hours or more (11.1%). The proportion of male students exercising for more than 1 hour was 55.7%, which was higher than that of females (39.0%), and the difference was significant between gender ($P < 0.05$) (Figure 2-2-1-14, Tables 3-2-2-15 and 3-2-2-16).

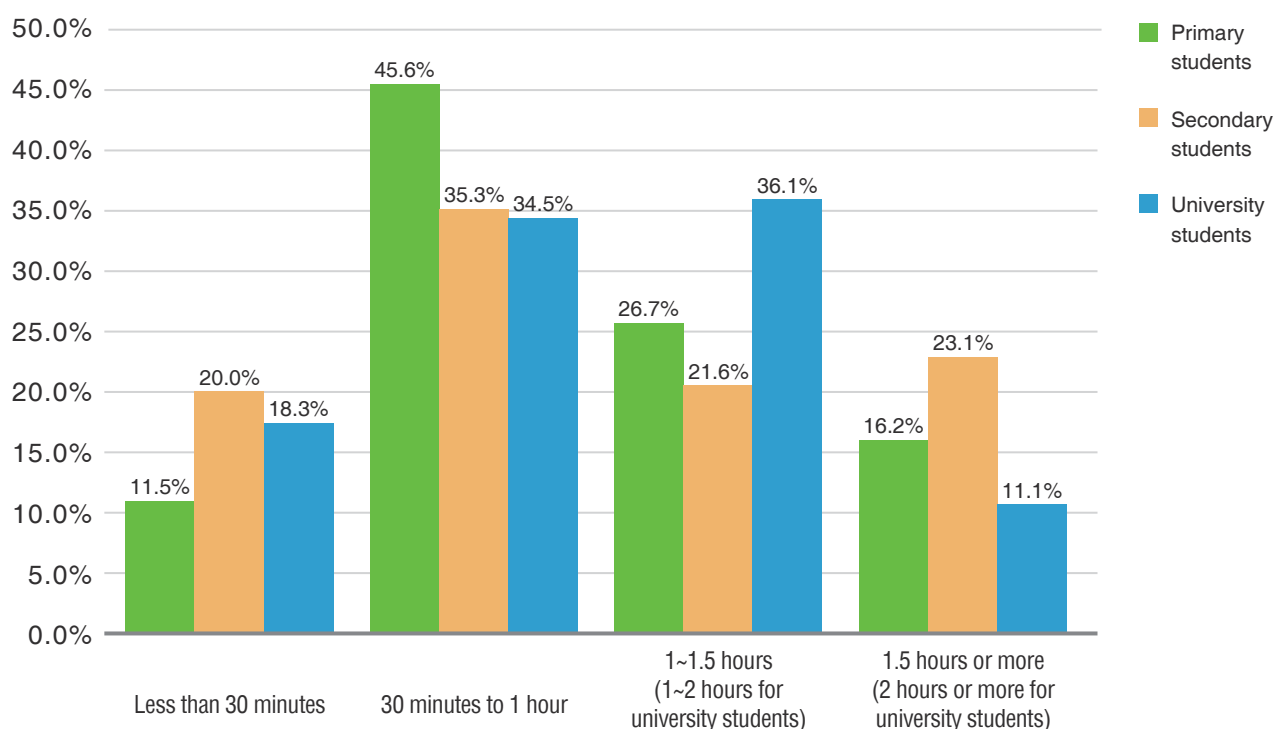

Figure 2-2-1-14 Average duration of each exercise in students

2.3.3 Intensity of Each Exercise

(1) Among primary students doing physical exercises, subjects who were able to reach moderate exercise intensity accounted for the highest proportion of 64.5%, followed by those reaching high exercise intensity (18.9%) and those reaching low exercise intensity (16.6%). Male students had a higher proportion (21.9%) than female students (15.0%) in reaching high exercise intensity, with significant gender difference observed ($P < 0.05$) (Figure 2-2-1-15, Tables 3-2-2-17 and 3-2-2-18).

(2) Among secondary students doing physical exercises, subjects who were able to reach moderate exercise intensity reached a peak of 58.7%, followed by those reaching high exercise intensity (32.9%) and those reaching low exercise intensity (8.4%). Male students had a higher proportion (37.5%) than female students (27.3%) in reaching high exercise intensity, with significant difference between gender ($P < 0.05$) (Figure 2-2-1-15, Tables 3-2-2-17 and 3-2-2-18).

(3) Among university students doing physical exercises, subjects who were able to reach moderate exercise intensity had the highest proportion of 55.3%, followed by those reaching high exercise intensity (40.5%) and those reaching low exercise intensity (4.2%). Male students had a higher proportion (51.1%) than female students (30.2%) in reaching high exercise intensity, with significant difference between gender ($P < 0.05$) (Figure 2-2-1-15, Tables 3-2-2-17 and 3-2-2-18).

In terms of comparison of exercise intensity among primary, secondary and university students, significant difference was observed in each level of exercise intensity ($P < 0.05$). The study results showed that primary students had a lower proportion (18.9%) than secondary (32.9%) and university students (40.5%) in reaching high exercise intensity. It also showed that university students had a higher proportion (40.5%) than secondary students (32.9%) in reaching high exercise intensity and a lower proportion (4.2%) than secondary students (8.4%) in reaching low exercise intensity, with significant difference observed ($P < 0.05$) (Figure 2-2-1-15).

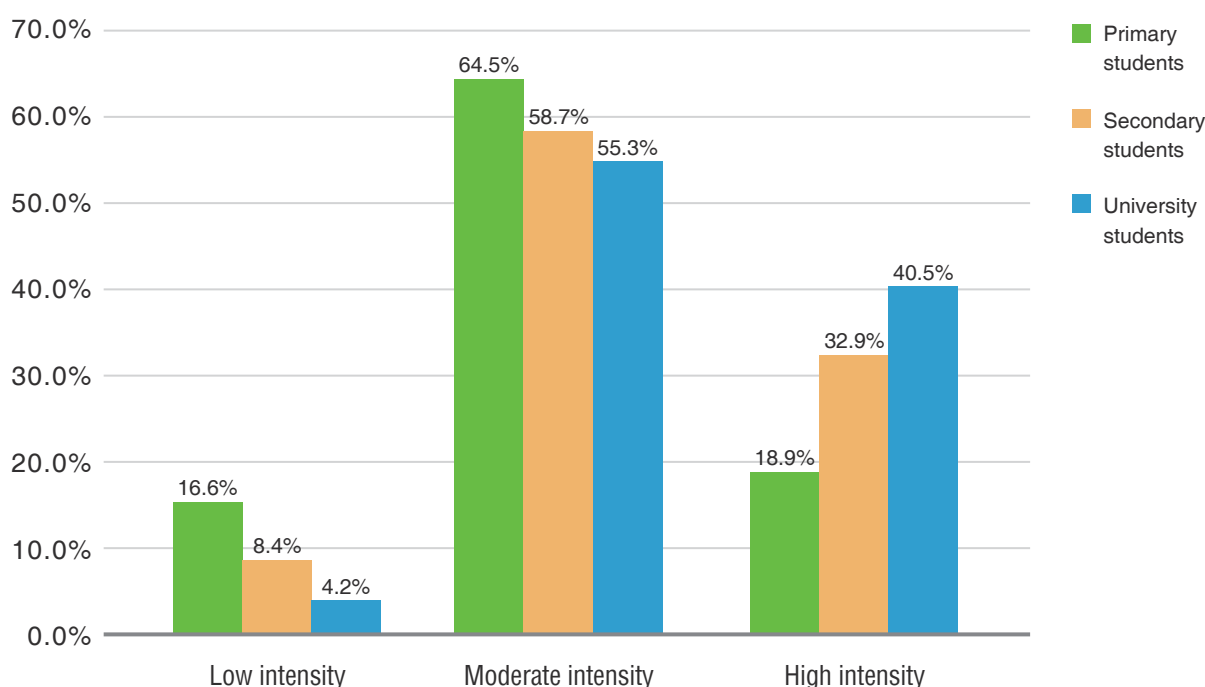

Figure 2-2-1-15 Self-perception of intensity of physical exercises in students

2.3.4 Analysis of Frequent Exercisers

Among primary and secondary students who participated in extracurricular physical exercises (since PE class is an optional course for university students, the physical exercise frequency of university students comprises both extracurricular exercises and PE classes), subjects who exercised 3 or more times weekly, with a duration longer than 30 minutes each time and an exercise intensity reaching moderate level, were defined as “frequent exercisers”.

Our study showed that 25.5% of primary student, 18.1% of secondary students and 32.5% of university students were frequent exercisers.

2.4 Major Physical Exercises

(1) In primary students (P1~3), the top 5 physical exercises for male students were running, walking, swimming, cycling and basketball; while the top 5 for female students were walking, running, dancing, swimming and cycling (Tables 3-2-2-19 and 3-2-2-20).

(2) In primary students (P4~6), the top 5 physical exercises for male students were swimming, cycling, basketball, brisk walking and badminton; while the top 5 for female students were swimming, cycling, rope skipping, brisk walking and rhythmic gymnastics (Tables 3-2-2-19 and 3-2-2-20).

(3) In secondary students, the top five physical exercises for male students were basketball, short- and middle-distance running, brisk walking, badminton and cycling; while the top 5 for female students were short- and middle-distance running, brisk walking, badminton, cycling and swimming (Tables 3-2-2-19 and 3-2-2-20).

(4) In university students, the top five physical exercises for male students were running, walking, basketball, badminton and swimming; while the top 5 for female students were walking, running, badminton, yoga, Pilates and swimming (Tables 3-2-2-19 and 3-2-2-20).

2.5 Strength exercise

Strength exercise includes bodyweight exercises such as push-ups, sit-ups, pull-ups, and squats; or equipment workouts such as using dumbbells and elastic bands. The study results showed that the proportion of subjects who had never participated in strength exercise was the highest, with a proportion primary students > university students > secondary students. The analysis was as follows:

(1) Among primary students, 53.5% of male students and 51.2% of female students didn't have the habit of strength exercise; 19.9% of male students and 19.6% of female students did strength exercise 1 day per week; 12.6% of male students and 15.3% of female students did strength exercise 2 days per week; and 14.0% of male students and 13.8% of female students did strength exercise 3 or more days per week. Thus, more than half of male and female students never did strength exercise, but no significant difference was found between gender (Figure 2-2-1-16, Tables 3-2-2-21 and 3-2-2-22).

(2) Among secondary students, 34.5% of male students and 46.4% of female students didn't do strength exercise; 19.9% of male students and 24.0% of female students did strength exercise 1 day per week; 17.4% of male students and 15.0% of female students did strength exercise 2 days per week; 28.3% of male students and 14.5% of female students did strength exercise 3 or more days per week. It showed that male students had a higher proportion than female students in doing strength exercise 3 or more days per week, with significant difference observed ($P < 0.05$), and the frequency of strength exercise of male students was higher than that of female students (Figure 2-2-1-16, Tables 3-2-2-21 and 3-2-2-22).

(3) Among university students, 35.8% of male students and 49.9% of female students didn't do strength exercise; 17.0% of male students and 18.8% of female students did strength exercise 1 day per week; 18.5% of male students and 15.0% of female students did strength exercise 2 days per week; 28.8% of male students and 16.4% of female students did strength exercise 3 or more days per week. It showed that male students had a higher proportion than female students in doing strength exercise 3 or more days per week, with significant difference ($P < 0.05$) observed, and the frequency of strength exercise of male students was higher than that of female students (Figure 2-2-1-16, Tables 3-2-2-21 and 3-2-2-22).

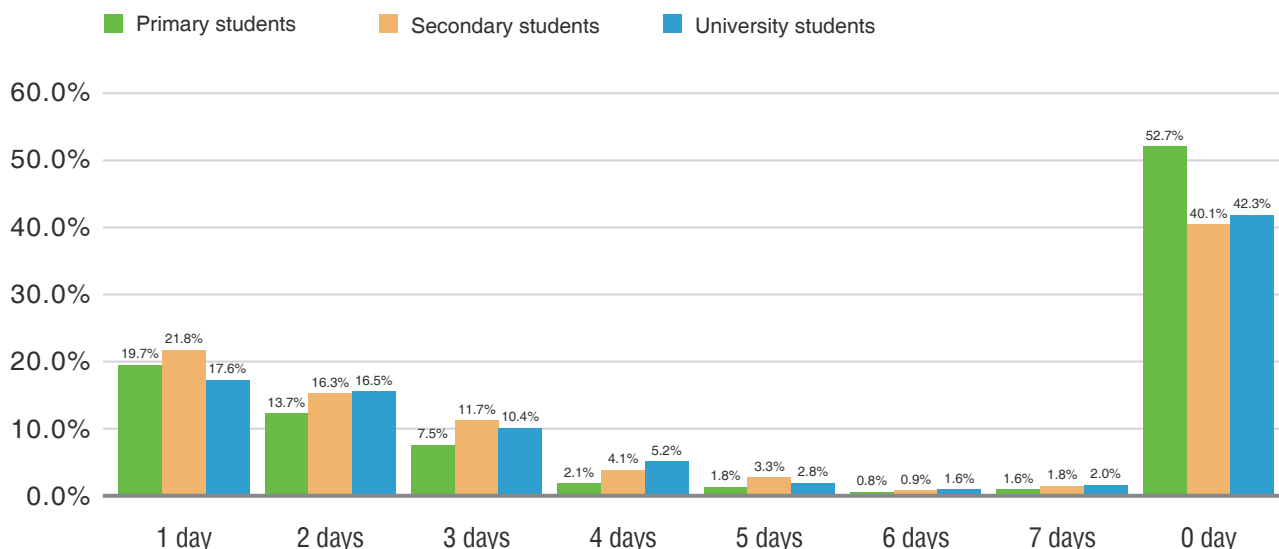

Figure 2-2-1-16 Frequency of strength exercise per week in students

2.6 Occurrence of Diseases

2.6.1 Analysis of Prevalence of Diseases

Among student subjects, 28.2% had suffered from hospital-diagnosed diseases in the past 5 years. The occurrence of disease among males and females were 28.5% and 27.9%, respectively (Figure 2-2-1-17, Tables 3-2-2-23 and 3-2-2-24).

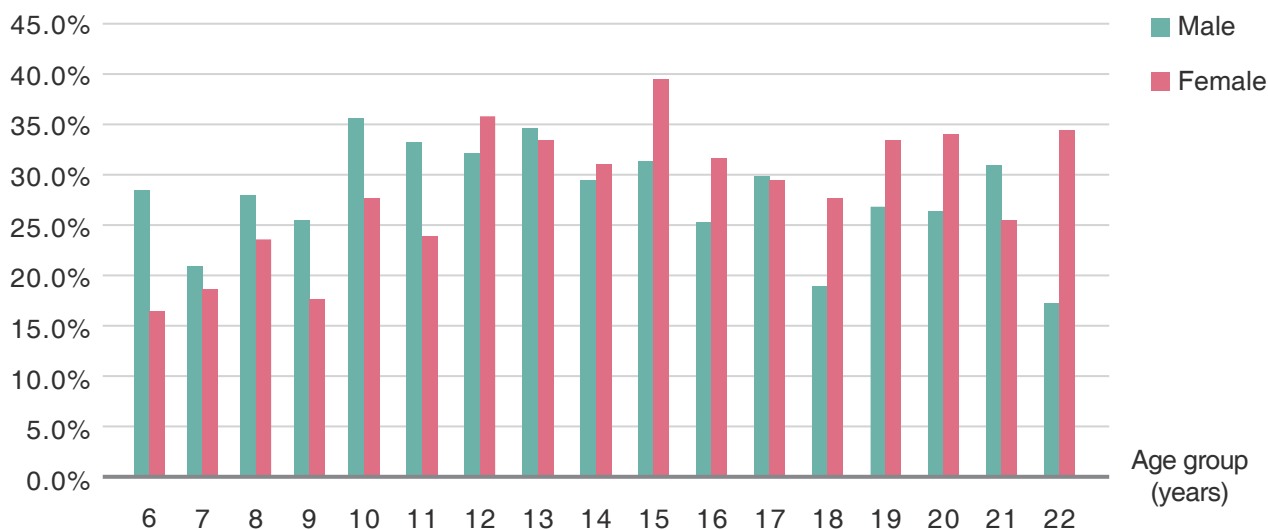

Figure 2-2-1-17 Occurrence of diseases in the past 5 years in students

2.6.2 Prevalence of Diseases

(1) Among primary students, the top five diseases were allergic rhinitis, gastroenteritis, tracheitis, others, and tonsillitis. For male students, the top five most frequent diseases observed were allergic rhinitis, gastroenteritis, others, tracheitis, and tonsillitis; and the top five in females were gastroenteritis, tracheitis, tonsillitis, allergic rhinitis, and others (Tables 3-2-2-25 and 3-2-2-26).

(2) Among secondary students, the top five diseases were gastroenteritis, allergic rhinitis, tonsillitis, varicella and tracheitis. For male students, the top five most frequent diseases were gastroenteritis, allergic rhinitis, asthma, tonsillitis and varicella; while the top five in females were gastroenteritis, allergic rhinitis, tonsillitis, varicella and anemia (Tables 3-2-2-25 and 3-2-2-26).

(3) Among university students, the top five diseases were dysmenorrhea & irregular menstruation, acute / chronic gastroenteritis, mouth ulcers, acute / chronic rhinitis, and others. For male students, the top five most frequent diseases were accidental injury, acute/chronic gastroenteritis, acute/chronic rhinitis, others, and asthma; the top five in females were dysmenorrhea & irregular menstruation, mouth ulcers, acute/chronic enteritis, acute/chronic rhinitis, and others (Tables 3-2-2-25 and 3-2-2-26).

2.7 Dental Hygiene

Among student subjects, more than 90% brushed their teeth every day. More female students (97.8%) than male students (96.0%) brushed their teeth daily, with significant gender difference observed ($P < 0.05$). Over 96% of female students aged 12 onwards had the habit of daily tooth brushing (Figure 2-2-1-18, Tables 3-2-2-27 and 3-2-2-28).

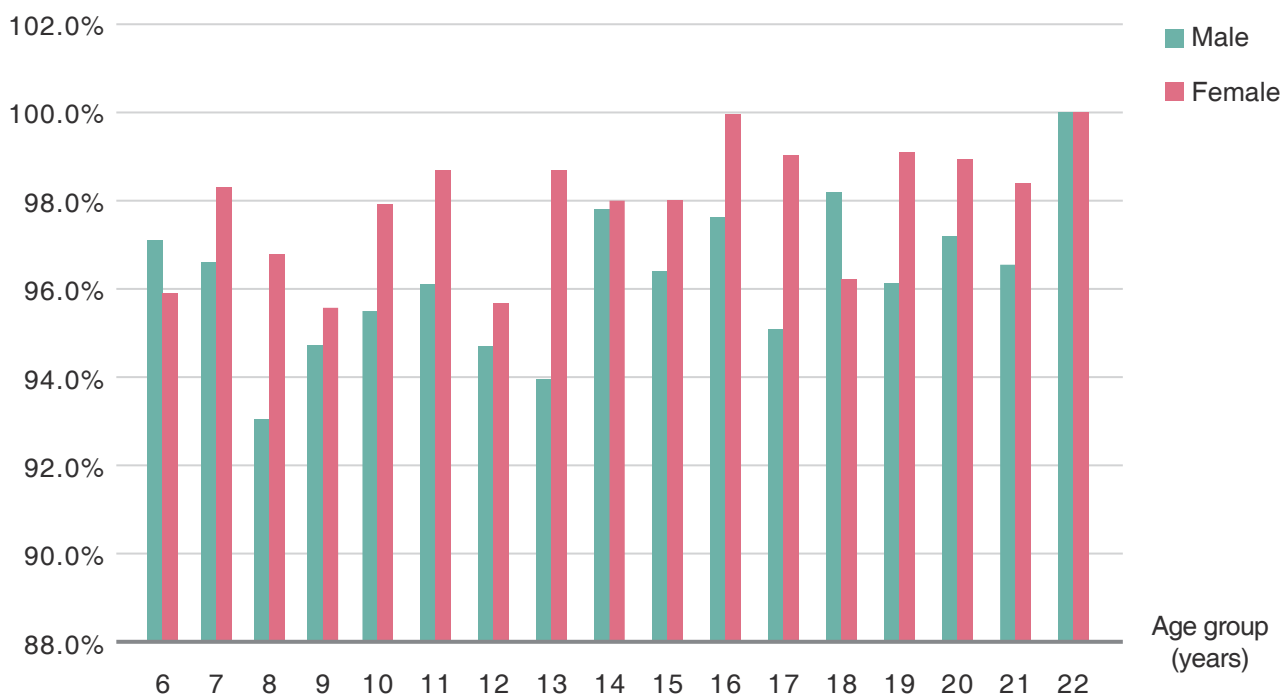

Figure 2-2-1-18 Proportion of daily tooth brushing in students

The proportion of students flossing their teeth daily was unsatisfactory. Among male students aged 6, 11, 14, 20, 21 and female students aged 6, 9, 12, 14~18 and 20~22, over 15% of them flossed daily. In general, daily flossing accounted for less than 15% in other age groups. Female students had a higher proportion (15.3%) in daily flossing than male students (12.6%), with significant gender difference observed ($P < 0.05$) (Figure 2-2-1-19, Tables 3-2-2-29 and 3-2-2-30).



Figure 2-2-1-19 Proportion of daily flossing in students

The proportion of students visiting dental clinics for dental examination in the past year was peaked at age 8, which were 72.0% and 70.7% for male and female students, respectively (Figure 2-2-1-20, Tables 3-2-2-31 and 3-2-2-32).

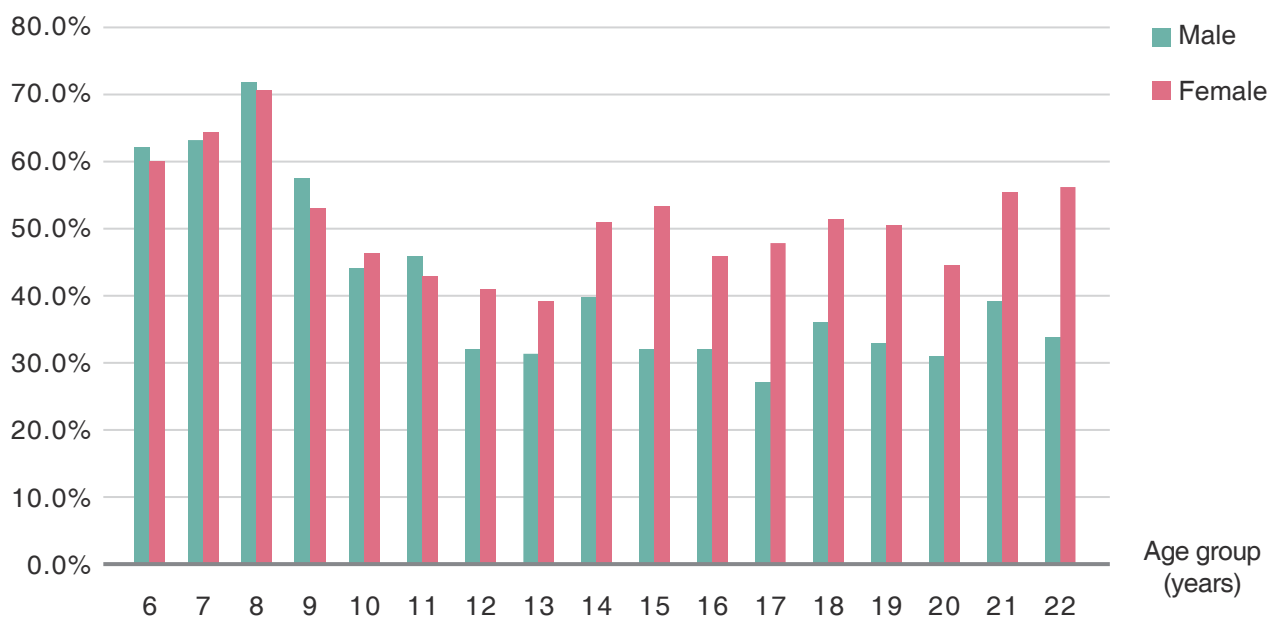

Figure 2-2-1-20 Proportion of students visiting dental clinics for dental examination in the past year

Among student subjects, the proportion of those who acknowledged their tooth decay problems showed a first decreased and then increased trend since age 8. Between ages 8~12, the proportion of students acknowledging their tooth decay problems declined and it rose up again after age 12. Female students had better perception on their dental caries than male students in all age groups except the aged 6, 7 and 9 groups. The greatest difference between gender was 26.5% as recorded in the 21 year age group (Figure 2-2-1-21, Tables 3-2-2-33 and 3-2-2-34.)

Among students with dental caries, 77.6% of male students and 78.7% of female students had visited dental clinics for treatment, which showed that males students had a lower proportion than female students, with significant difference found in the 14, 16~20 year age groups ($P < 0.05$) (Tables 3-2-2-35 and 3-2-2-36).

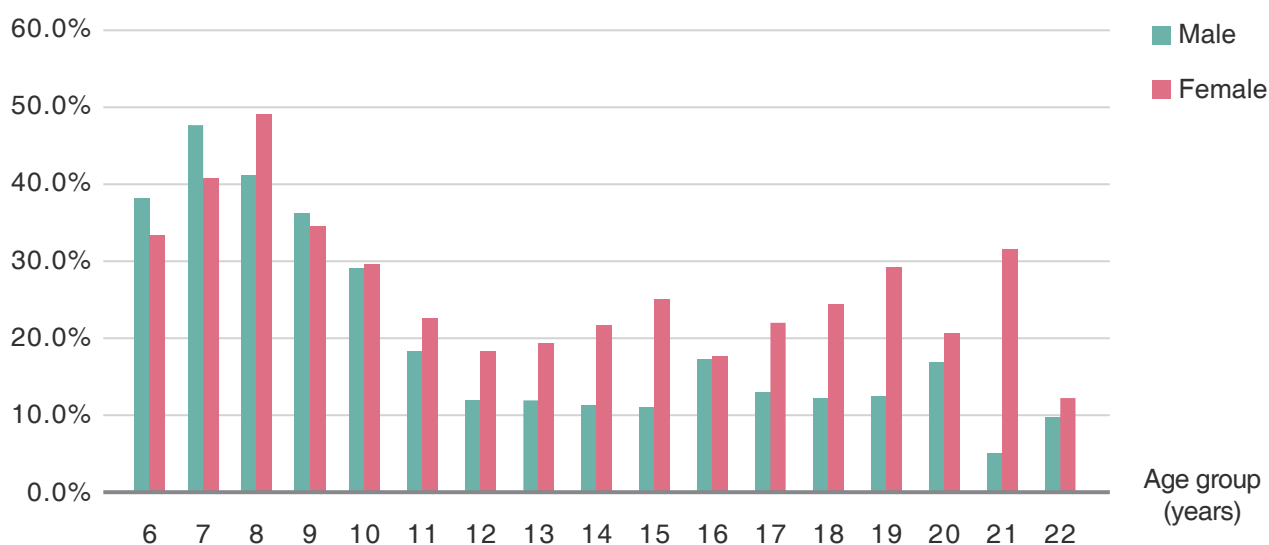

Figure 2-2-1-21 Proportion of students who had perception of their dental caries

2.8 Fitness Literacy

Scientific fitness literacy means that people scientifically develop their fitness potential according to their respective strengths, actively interact with the environment and build a virtuous cycle from motivation, knowledge and understanding, attitude, ability, and skills to behavior and habits, and finally be able to consciously improve a certain level of lifelong participation in sports, fitness and other related activities. The evaluation of scientific fitness literacy consists of 4 first-level dimensions and 12 second-level dimensions. The first-level dimensions encompass cognition, attitude, ability and skills, and behavior and habit. More specifically, cognition refers to people's understanding and judgement produced by the information processing of objective things through perceiving, recognizing, remembering, conceiving, thinking and other actions; attitude refers to the stable psychological predisposition of an individual to a given object (person, concept, emotion or event, etc.). Ability in "ability and skills" refers to the physical abilities of individuals to perform basic movements, namely, the most essential and basic skills of body movements in their daily lives and social practice; whereas skill refers to sports skills, which are exercise movements acquired through learning. As for the term "behavior and habits", behavior has the same definition as physical fitness behavior in the traditional sense, and the most significant characteristic of habit is the length of persisting time of fitness behavior.

This study was based on the questionnaire survey conducted among Macao residents aged 3~79 in 2020. All the evaluative dimensions of scientific fitness literacy were examined in the age groups of 10~12, 13~18, 19~59 (subdivided into aged 19~29, 30~39, 40~49, 50~59 groups), and 60~79 (subdivided into the aged

60~69, 70+ groups), aside from the aged 3~6 and 7~9 groups where only ability & skills and behavior & habits were examined (because subjects of such ages are not able to accurately understand and express their cognition and attitude towards scientific fitness). The study results collected from 1,172 subjects aged 7~9, 1,065 subjects aged 10~12 and 2,048 subjects aged 13~18 were analyzed as follows:

2.8.1 Cognition

Approximately 70% of children and adolescents had a correct cognition of fitness. This proportion in children and adolescents was not quite high, especially for subjects aged 13~18 who had a correct cognition of fitness accounted for only 68.7%, while such proportion in Mainland China reached 90% (Figure 2-2-1-22).

Health is considered to be the primary benefit of exercise. Among various benefits of exercise, children and adolescents exhibited the highest degree of recognition for health, reaching a peak of over 90%. The recognition of children and adolescents for the effects of exercise was much higher than that of adults and seniors (Figure 2-2-1-23).

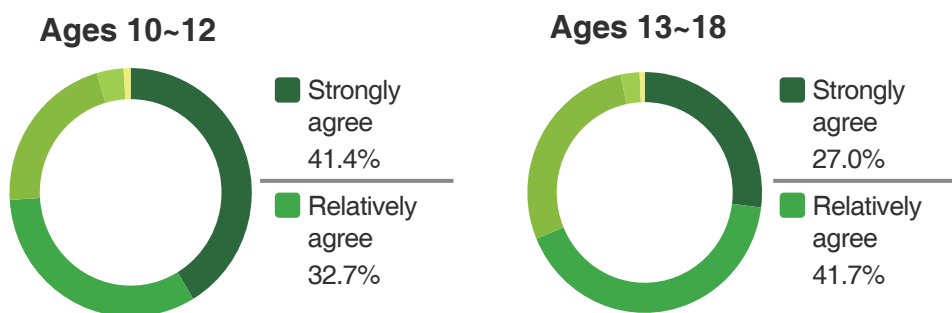

Figure 2-2-1-22 Proportion of children and adolescents with correct fitness cognition

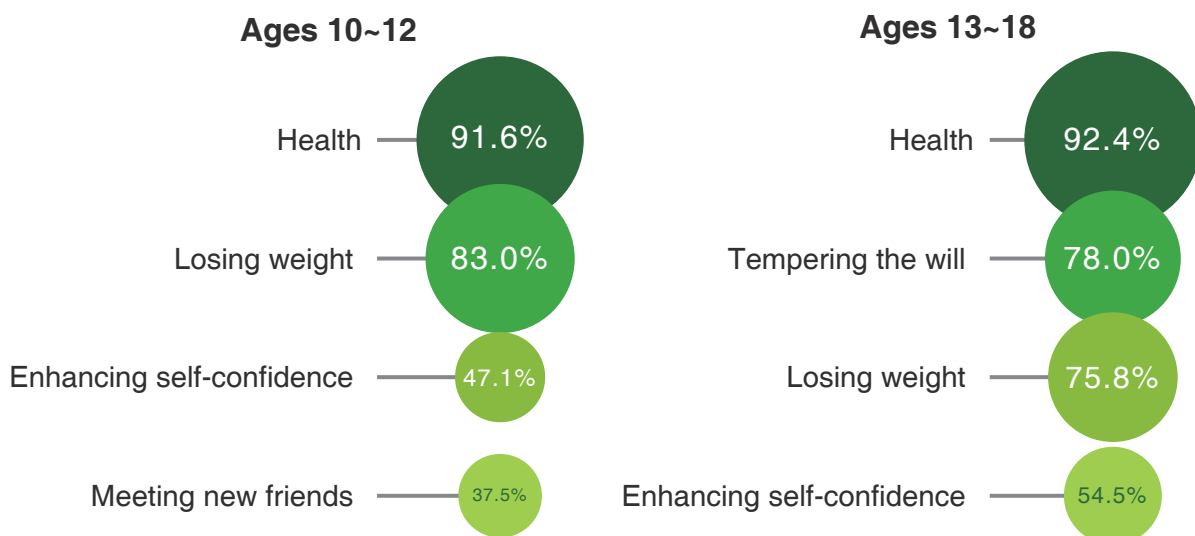

Figure 2-2-1-23 Distribution of cognition of fitness benefits in children and adolescents

2.8.2 Attitude

About 70% of children and adolescents held a positive attitude (fun and pleasant) towards exercise, with a proportion of 78% and 65.8% in the aged 10~12 and 13~18 groups, respectively, which was lower than adults and seniors. Whereas, the indicator value of children and adolescents aged 10~12 in Mainland China was close to that in Macao, while the indicator value of children and adolescents aged 13~18 was 15% higher than that in Macao.

As indicated in the research, the relationship among emotion, belief, behavior disposition and specific behaviors is progressive and interactional. Belief refers to an individual's conviction and trust in his/her own ideas and abilities. Behavior disposition refers to an individual's reaction towards an objective or the readiness condition of behaviors. Deviation in any link may influence the specific behaviors.

About 60% of children and adolescents were sure of their exercise abilities, which was 10% lower than that of emotion (i.e. positive attitudes mentioned above), without big difference among age groups. The proportion of subjects who were able to convert their emotions and abilities into a plan of action accounted for 42.3% and 31.0% in the aged 10~12 and 13~18 groups, respectively. In other words, merely 40% of children and adolescents had the intention to do exercise, and had made (or would make) specific schedules for physical exercise, such as time, venue and occasion (Figure 2-2-1-24).

On the other hand, the belief of children and adolescents in Mainland China was similar to that in Macao and their behavior disposition indicator was at least 10% higher than that in Macao.

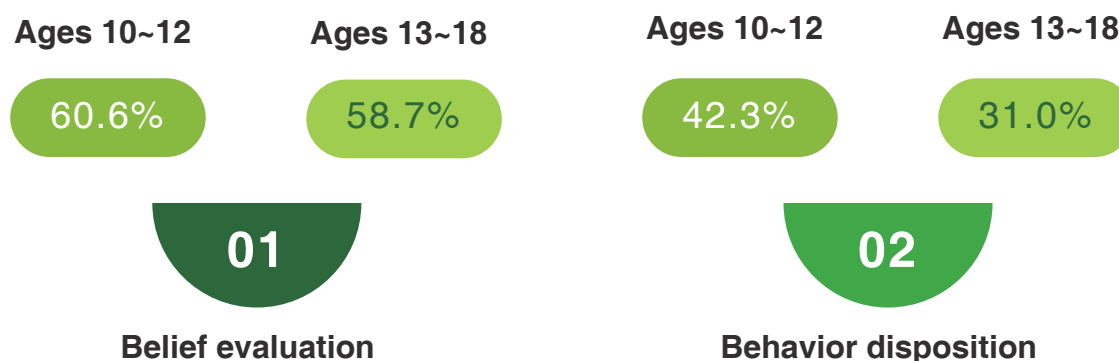

Figure 2-2-1-24 Exercise intention of children and adolescents

2.8.3 Ability and Skill

Children and adolescents participated in a wide range of physical exercises. Children and adolescents engaged in diverse physical exercises and their participation rate was found to be similar in each physical exercise. Subjects aged 3~6 were restricted by their exercise abilities, thus their exercise types were relatively monotonous, and their participation rate was relatively concentrated. For subjects aged 7~9 onwards, the number of physical exercises in which they participated started to increase progressively. The average number of physical exercises was 6.83 per person in the aged 7~9 groups and it was increased to 12.73 per person in the aged 13~18 groups (Figure 2-2-1-25).

	Young children	Primary students (P1~3)	Primary students (P4~6)	Secondary students	University students
1	Walking 66.5%	Walking 55.7%	Swimming 37.6%	Short - and middle - distance running 34.1%	Running 70.5%
2	Running 51.1%	Running 53.6%	Cycling 36.8%	Brisk walking 27.0%	Walking 68.8%
3	Cycling 42.3%	Swimming 39.8%	Brisk walking 28.2%	Badminton 24.7%	Basketball 34.3%
4	Swimming 30.2%	Cycling 38.4%	Badminton 26.8%	Basketball 24.0%	Badminton 34.1%
...	Sports games, dancing, football	Dancing, rope skipping, gymnastics, football, basketball	Basketball, short - and middle - distance running, rope skipping, table tennis, gymnastics, rhythmic gymnastics	Cycling, swimming, long-distance running, table tennis, rope skipping	Swimming, cycling, yoga or Pilates, strength training or body building, rope skipping, table tennis

Figure 2-2-1-25 Proportion of children and adolescents participating in physical exercises

In comparison, the type of physical exercises in which children and adolescents in Mainland China participated was relatively fewer, but the concentration degree was relatively higher and increased with advancing age, while the type of physical exercises remained similar with advancing age (Figure 2-2-1-26).

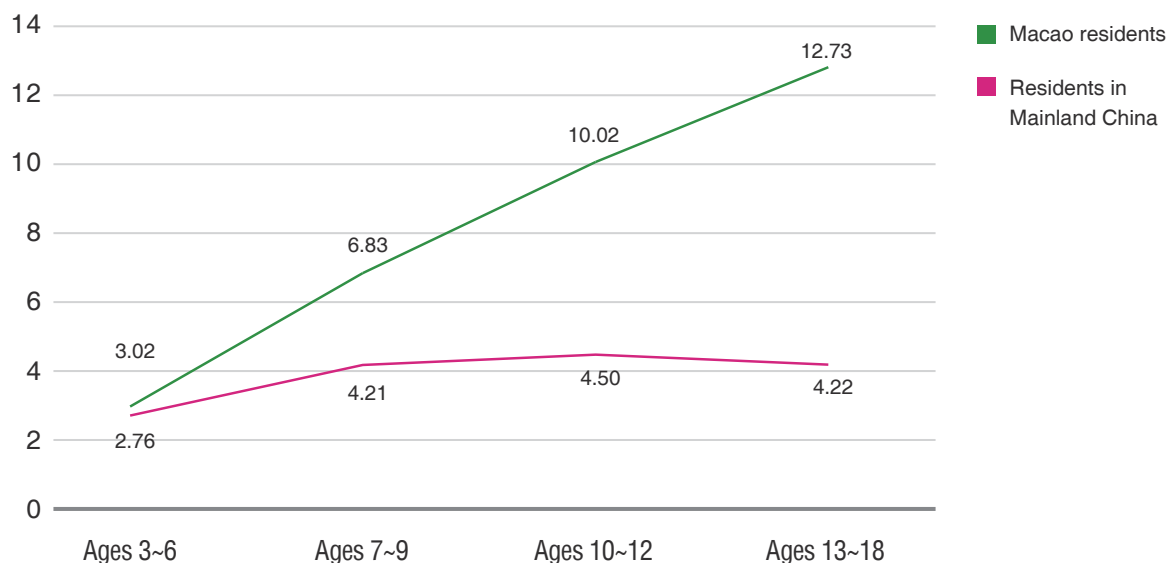

Figure 2-2-1-26 Average number of physical exercises of children and adolescents in Macao and Mainland China

2.8.4 Behavior and Habit

About 4.5% of children and adolescents reached the amount of exercise recommended by the WHO. According to the Guidelines on Physical Activity and Sedentary Behavior (2020 version) issued by the WHO, the recommended amount of exercise for children and adolescents aged 5~17 is at least 60 minutes of aerobic exercises in moderate or above intensity per day, including at least 3 days of strength training. Based on this recommendation and assuming there were 2 PE classes weekly, the proportion of subjects who were able to reach the above criteria recommendation accounted for 0.93%, 4.39% and 4.43% in the aged 7~9, 10~12 and 13~18 groups, respectively. Based on the standards of frequent exercisers, the proportion of those who met the standards recommendation accounted for 66.04%, 59.29% and 55.38% in the aged 7~9, 10~12 and 13~18, respectively.

3. Anthropometric Measurements

3.1 Length Indicators

The average height for male and female students was ranged from 120.0~174.1cm and 118.7~161.8cm, respectively (Table 3-2-3-1). For ages beyond 11, male students had a higher average height than female students in each age group. No significant difference between gender was found in students aged 6~12, but it differed significantly between gender in students aged 13 and onwards ($P < 0.05$) (Figure 2-2-1-27).

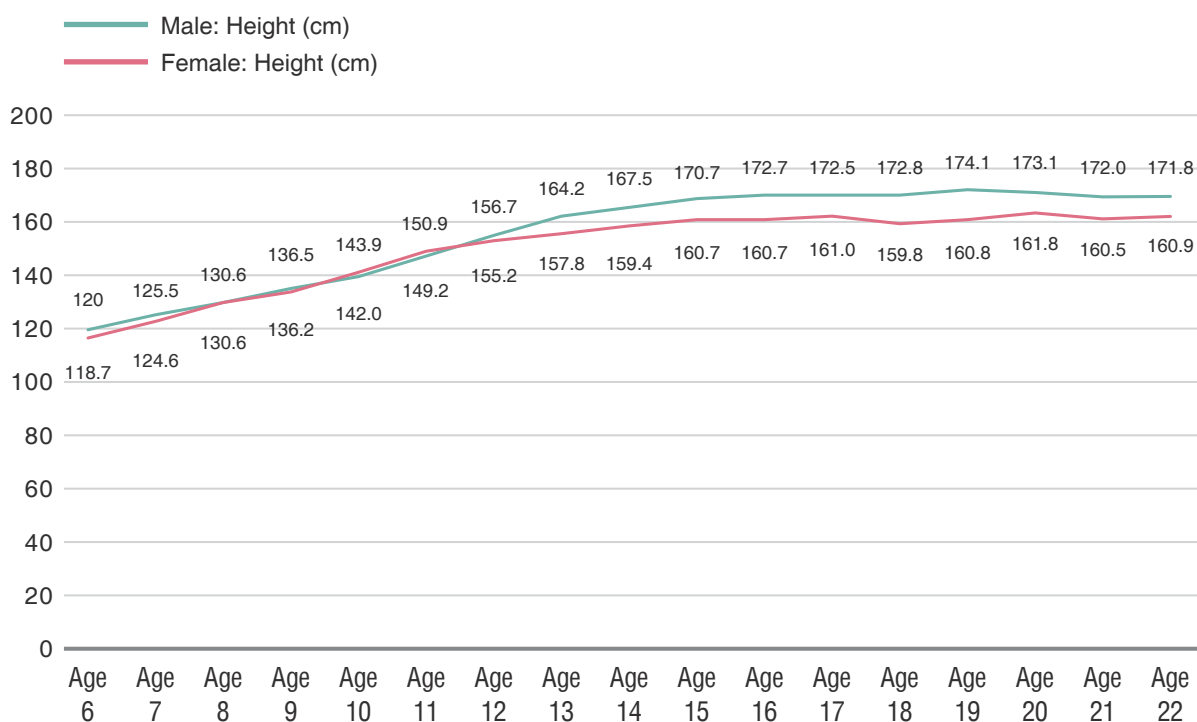

Figure 2-2-1-27 Average height of students

The average sitting height for male and female students was ranged from 65.9~93.1cm and 65.2~87.1cm, respectively (Table 3-2-3-2). For ages beyond 12, the average sitting height of male students was higher than that of female students in each age group. The average sitting height of male students was lower than that of female students in the aged 10 and 11 groups, but higher in the aged 13~22 groups, with significant difference between gender ($P < 0.05$). Whereas, no significant difference was found in other age groups (Figure 2-2-1-28).

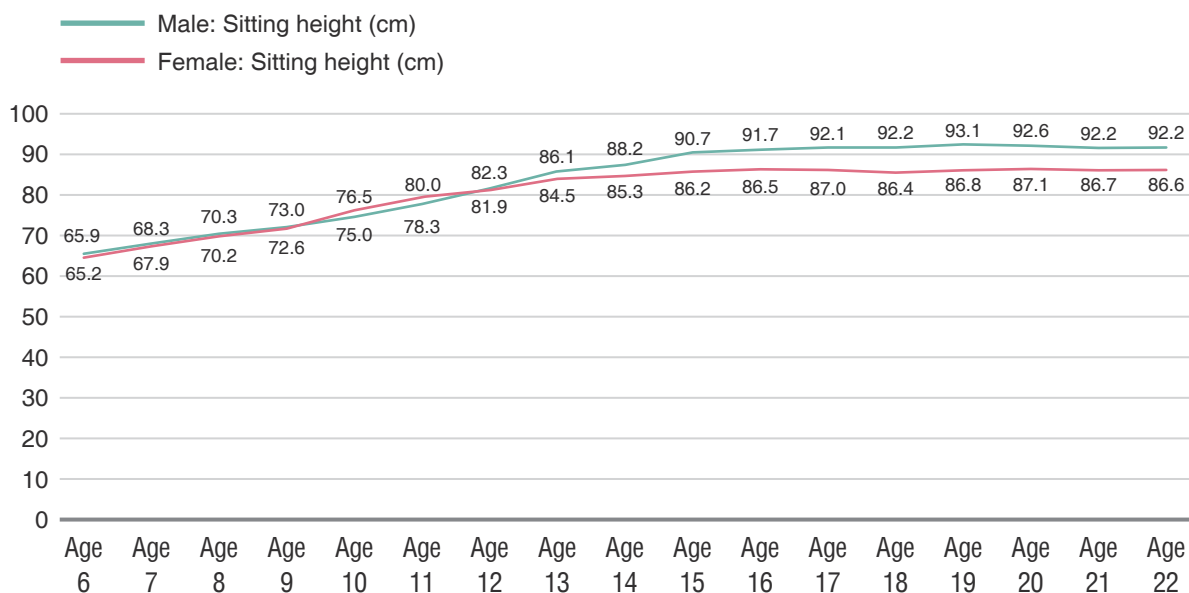

Figure 2-2-1-28 Average sitting height of students

Foot length increased with advancing age until age 16 for male students and age 15 for female students. The foot length reached 25.2cm for male students at age 16, and 23.1cm for female students at age 15. The average foot length of male and female students was ranged from 18.4~25.5cm and 18.1~23.1cm, respectively (Table 3-2-3-3). Male students had longer foot length than female students, with no significant difference found in the aged 8~10 groups, and significant gender difference found in the aged 6~7, 11~22 groups ($P < 0.05$) (Figure 2-2-1-29).

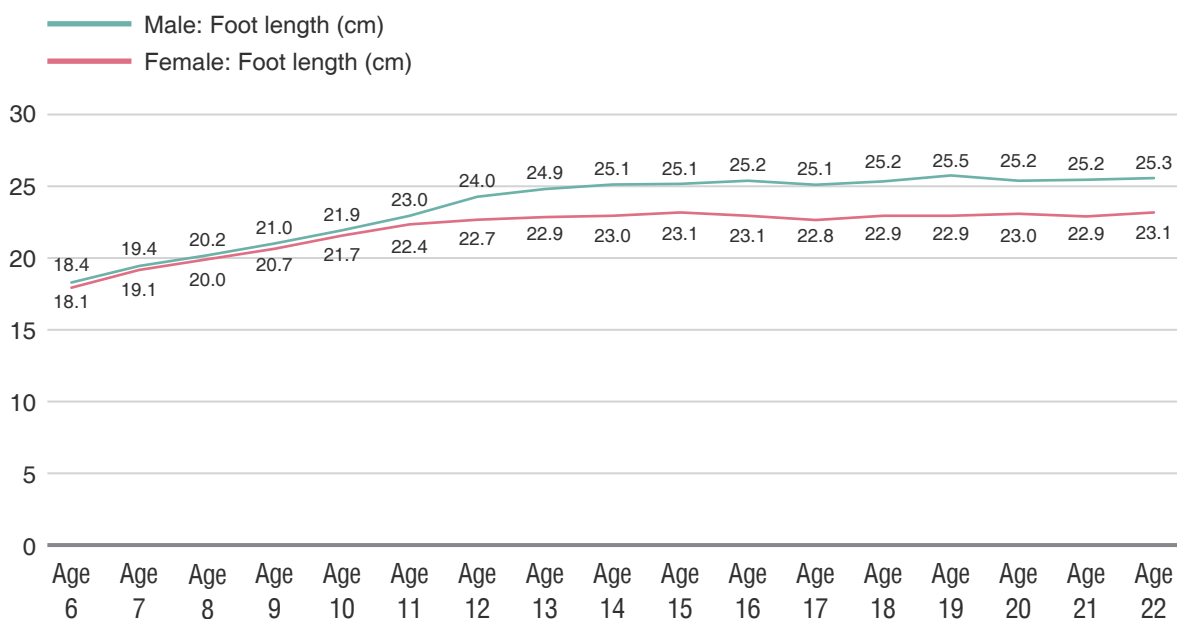

Figure 2-2-1-29 Average foot length of students

3.2 Weight, BMI and Body Fat Percentage

Before age 17, the weight of male students increased with advancing age, and it still fluctuated mildly after age 17. The weight of female students increased with advancing age before age 15, and remained stable after age 16. The average weight of male and female students was ranged from 23.0~71.1kg and 21.7~55.4kg, respectively (Table 3-2-3-4). The average weight of male students was higher than that of female students, with no significant difference found in the aged 7, 8, 10~12 groups, and significant gender difference in the aged 6, 9, 13~22 groups ($P < 0.05$) (Figure 2-2-1-30).

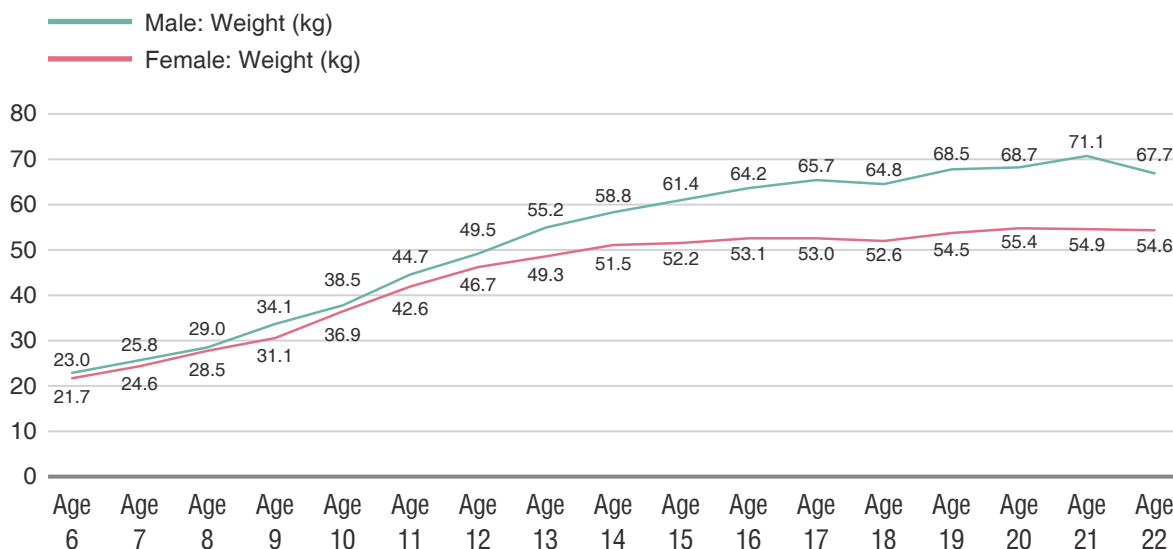

Figure 2-2-1-30 Average weight of students

The BMI of students showed an upward trend with advancing age between ages 6~17 for male students and 6~14 for female students and since then, the BMI of students fluctuated within a certain range. The average BMI of male and female students was ranged from 15.8~24.1 and 15.3~21.3, respectively (Tables 3-2-3-5). The average BMI of male students was higher than that of female students, with significant gender difference found in the aged 9~11, 17~21 groups ($P < 0.05$), but the difference was not significant in other age groups (Figure 2-2-1-31).



Figure 2-2-1-31 Average BMI of students

The Body fat percentage of both male and female students fluctuated in each age group with no obvious tendency. However, the BMI of students tended to increase with advancing age, indicating that the weight gain was mainly resulted from an increase in muscles and bones, rather than an increase in body fat. The average body fat percentage of female students was higher than that of male students in each age group. Significant difference was found in all age groups except the aged 9 group ($P < 0.05$) (Table 3-2-3-6, Figure 2-2-1-32).

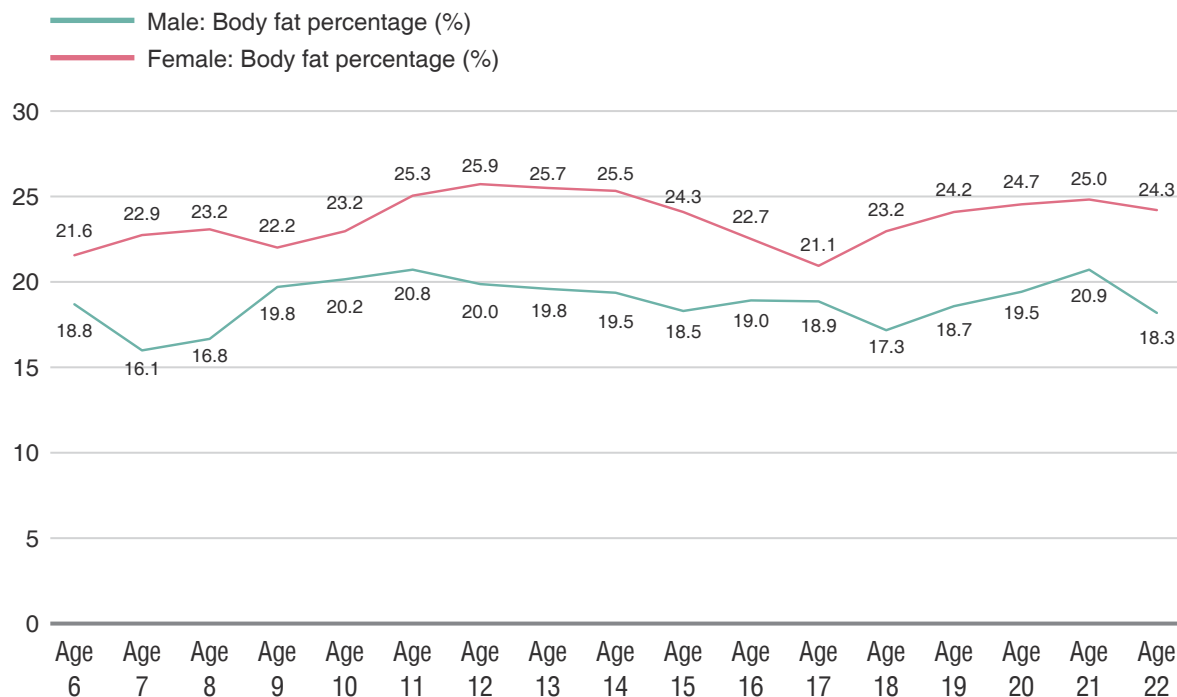

Figure 2-2-1-32 Average body fat percentage of students

According to the critical values for BMI classification of underweight, normal weight, overweight and obesity in the Health Industry Standards of People's Republic of China WS/T 586-2018 and WS/T 456-2014, the analyzed results for children and adolescents were as below: between ages 6~12, male students who were underweight, healthy, overweight and obese accounted for 12.0%, 56.0%, 15.7% and 16.3%, respectively; female students who were underweight, healthy, overweight and obese accounted for 9.6%, 71.1%, 9.8% and 9.6%, respectively. The prevalence of overweight and obesity of male students was higher than that of female students. Between ages 13~18, male students who were underweight, healthy, overweight and obese accounted for 15.2%, 56.4%, 17.6% and 10.8%, respectively; female students who were underweight, healthy, overweight and obese accounted for 9.6%, 75.6%, 10.0% and 4.8%, respectively. The prevalence of overweight and obesity of male students was higher than that of female students. Between ages 19~22, male students who were underweight, healthy, overweight and obese accounted for 10.8%, 53.9%, 24.4% and 10.8%, respectively; female students who were underweight, healthy, overweight and obese accounted for 18.8%, 66.0%, 9.7% and 5.5%, respectively. The prevalence of overweight and obesity of male students were higher than that of female students. Comparative analysis of the above three age categories showed that the prevalence of overweight male students was ages 6~12 < ages 13~18 < ages 19~22, showing an overall increasing trend; whereas that of female students showed a first increased and then decreased trend. The prevalence of obesity of male students showed a first decreased and then stable trend, i.e. decreased from ages 6~12 to 13~18, and then remained stable at ages 19~22. Whereas the prevalence of obesity of female students showed a first decreased and then increased trend, indicating that the prevalence of obesity of female students decreased from primary school to senior secondary school, and then increased after they entered senior secondary school (Table 3-2-3-7).

3.3 Circumference Indicators

Chest, waist and hip circumferences of male and female students increased slightly with advancing age, with the rate of increase in waist circumference was slightly less than that in hip circumference. The average chest, waist and hip circumferences of students were ranged from 58.4~92.0cm (male) and 57.2~84.6cm (female), 53.9~80.9cm (male) and 52.4~71.1cm (female), and 63.2~95.0cm (male) and 63.3~93.9cm (female), respectively (Tables 3-2-3-8, 3-2-3-9, and 3-2-3-10). The average chest circumference of male students was higher than that of female students in the aged 9, 14~22 groups with significant gender difference ($P < 0.05$), but the difference was not significant in other age groups; the average waist circumference of male students was higher than that of female students, with no significant difference found in the aged 6~8 groups, but it differed significantly between gender in the aged 9~22 groups ($P < 0.05$); the average hip circumference of male students was lower than that of female students, with no significant gender difference found in the aged 6~10, 13~22 groups, but it differed significantly between gender in the aged 11, 12 groups ($P < 0.05$) (Figures 2-2-1-33, 2-2-1-34 and 2-2-1-35).

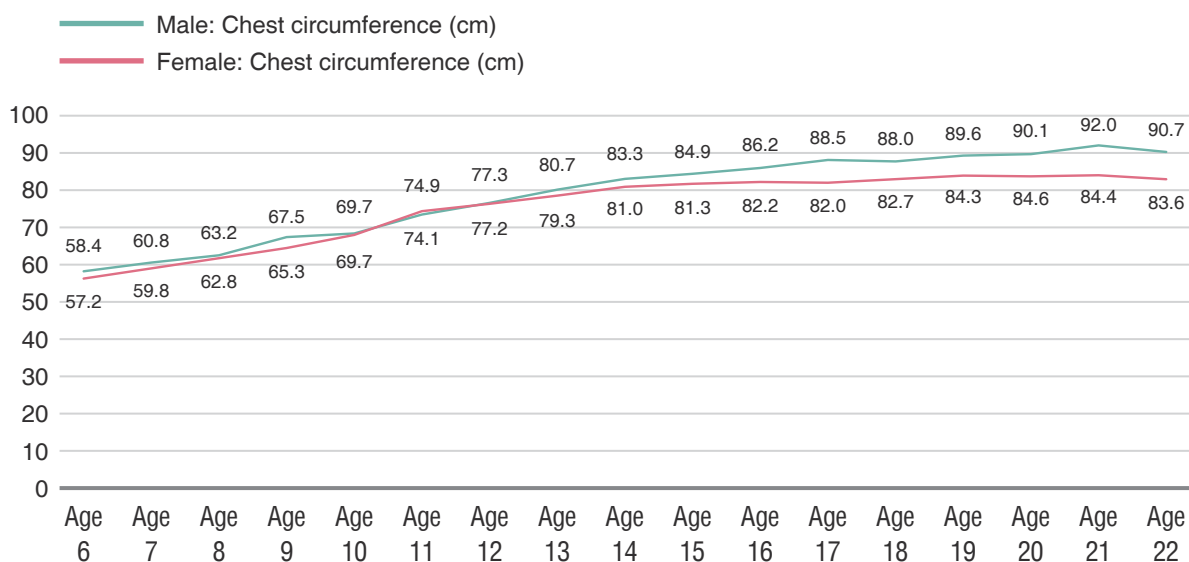

Figure 2-2-1-33 Average chest circumference of students

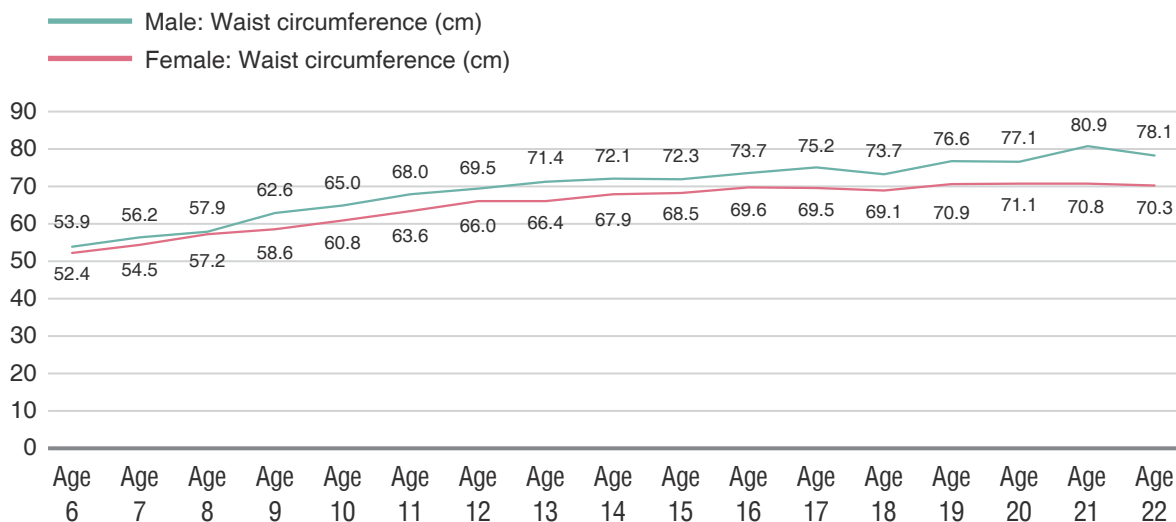

Figure 2-2-1-34 Average waist circumference of students

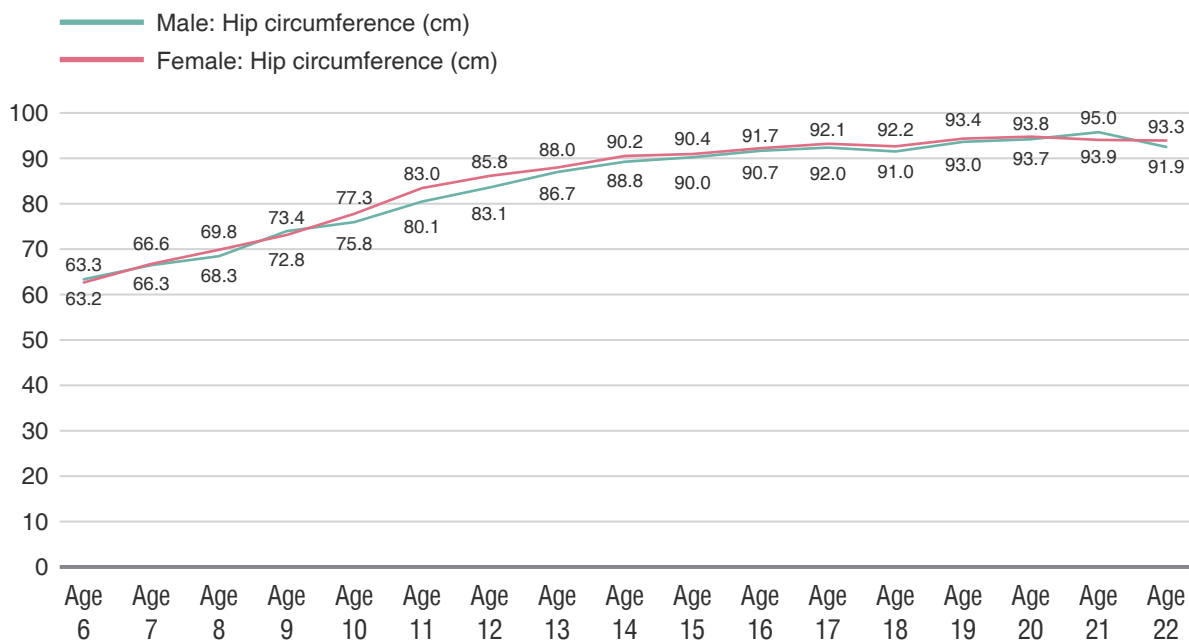

Figure 2-2-1-35 Average hip circumference of students

The waist-to-hip ratio (WHR) of male students remained almost constant between ages 6~10, and decreased afterwards at ages 11~15, and then increased after age 15. For female students, the WHR declined between ages 6~13, and remained stable after age 13. The average WHR of male and female students was ranged from 0.800~0.853 and 0.749~0.828, respectively. The average WHR of males was higher than that of females, which differed significantly between gender in each age group ($P < 0.05$) (Table 3-2-3-11, Figure 2-2-1-36).

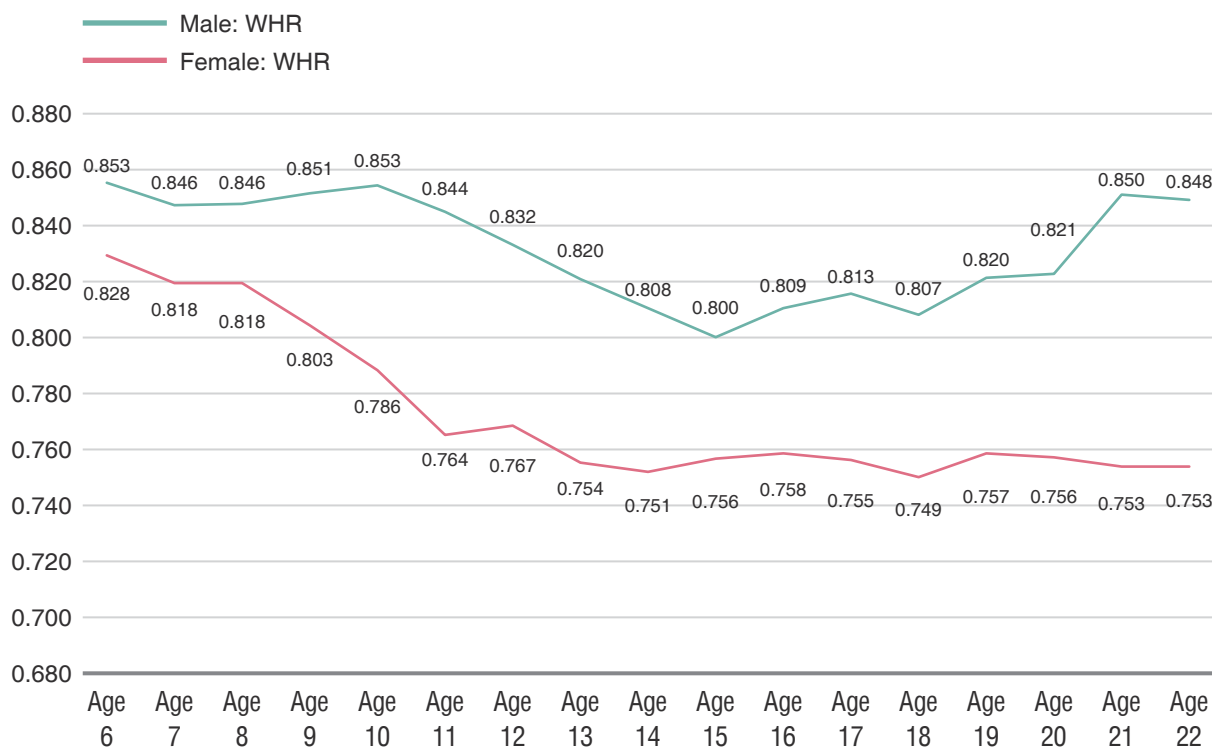

Figure 2-2-1-36 Average WHR of students

3.4 Width Indicators

Shoulder width increased with advancing age in students aged 6~17, with rapid increase at ages 6~15 for males and ages 6~14 for females, and slow increase thereafter. The average shoulder width of male and female students was ranged from 26.2~39.6cm and 25.8~35.7cm, respectively (Table 3-2-3-12). Pelvis width increased with advancing age at ages 6~17 for males and ages 6~15 for females. Afterwards, the pelvis width of male students kept stable, and that of female students increased slightly. The average pelvis width of male and female students was ranged from 19.2~27.9cm and 19.0~27.8cm, respectively (Table 3-2-3-13). Difference in shoulder width was not significant in the aged 6~11 groups, but the average shoulder width of male students was higher than that of female students in the aged 12~22 groups, with significant gender difference ($P < 0.05$). The average pelvis width of male students was lower than that of female students in the aged 8~10 groups, with no significant difference found; the average pelvis width of male students was lower than female students in the aged 11~14, 20, 22 groups, with significant gender difference ($P < 0.05$); and the average pelvis width of male students was higher than that of female students in the aged 6~7, 15~19, 21 groups, which differed significantly between gender ($P < 0.05$) (Figures 2-2-1-37, 2-2-1-38).

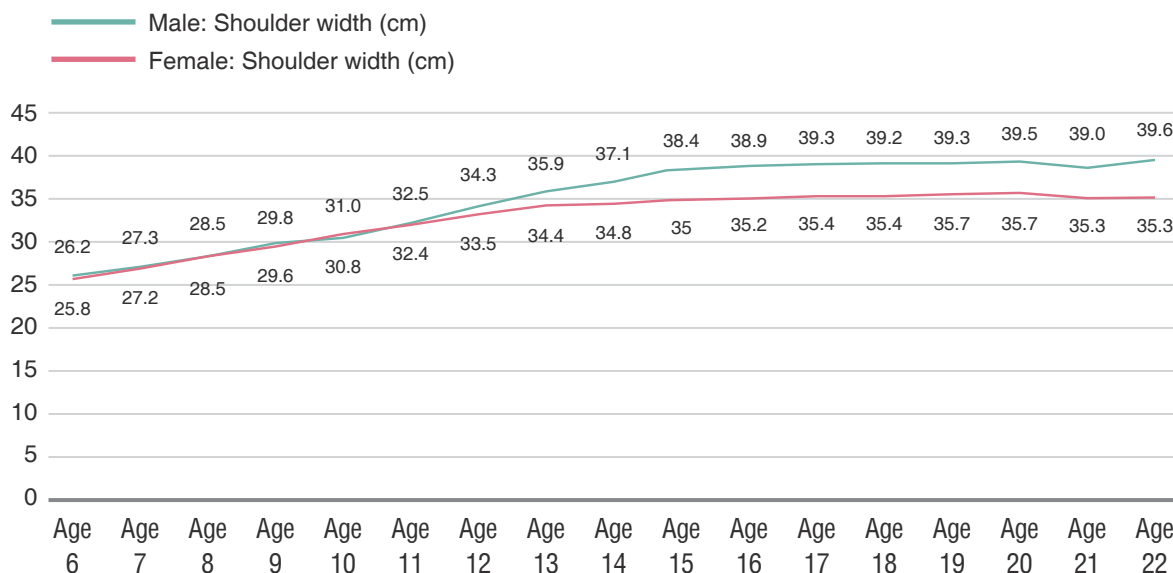

Figure 2-2-1-37 Average shoulder width of students

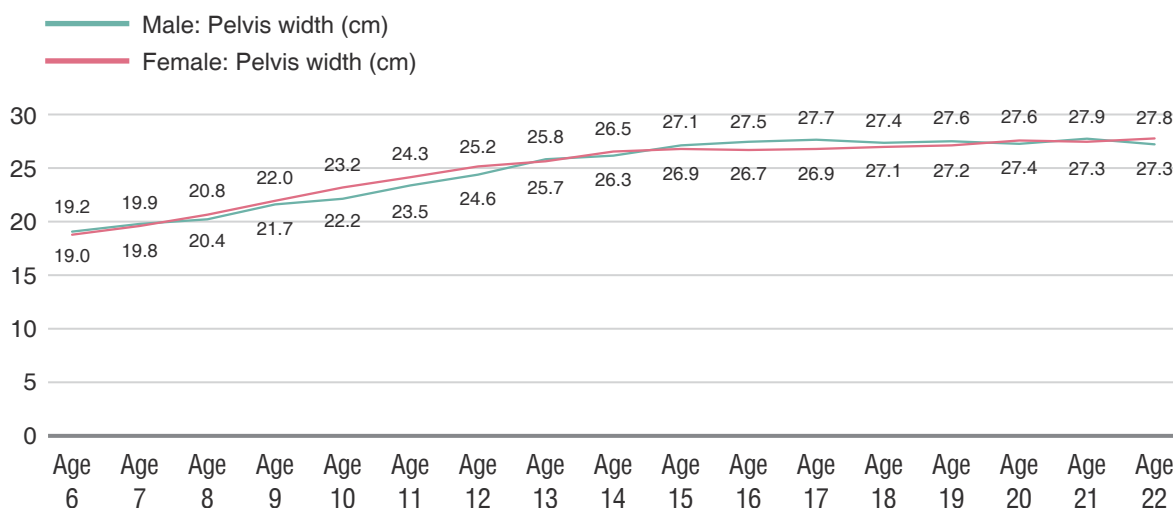

Figure 2-2-1-38 Average pelvis width of students

4. Physiological Function

Physiological function is reflected by resting pulse, blood pressure (systolic blood pressure and diastolic blood pressure) and vital capacity.

4.1 Resting Pulse

Resting pulse is a basic indicator to reflect the cardiopulmonary function. Generally, the resting pulse decreased with advancing age for female students aged 6~22 and male students aged 6~21, but there was a slight increase in male students after age 21. The average resting pulse was ranged from 75.3~88.9bpm and 77.9~90.1bpm for males and females, respectively (Table 3-2-4-1). The average resting pulse of females was higher than that of males in most age groups, which differed significantly between gender in the aged 11, 15, 16, 20, 21 groups ($P < 0.05$), and no significant difference was found in other age groups (Figure 2-2-1-39).

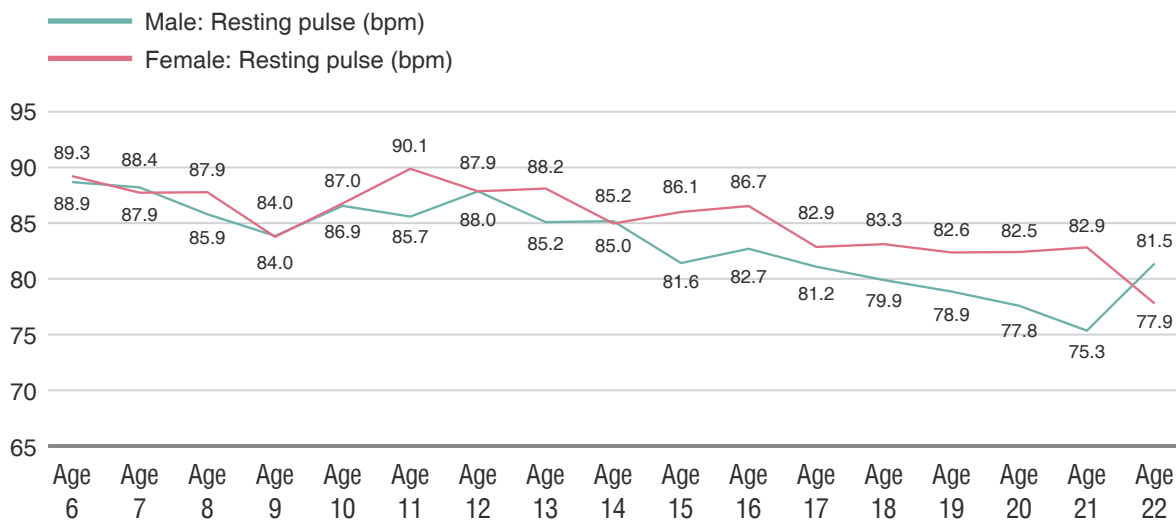

Figure 2-2-1-39 Average resting pulse of students

4.2 Blood Pressure

When the ventricle contracts, the blood pressure of artery rises and the highest value is called the systolic blood pressure (SBP), which reflects mainly the volume of blood being pumped out by each contraction. When the ventricle relaxes, the blood pressure of artery descends and the lowest value is called the diastolic blood pressure (DBP), which mainly reflects the peripheral resistance. The difference between SBP and DBP is called pressure difference, which reflects the elasticity of the artery wall.

The SBP of male and female students increased with advancing age. The SBP of female students showed a stable trend after age 13, while that of male student remained fairly stable after age 16. The average SBP for males and females was ranged from 100.9~125.4mmHg and 100.1~111.9mmHg, respectively (Table 3-2-4-2). The average SBP of males was higher than that of females, with no significant difference found in the aged 6~11 groups, but it differed significantly between gender in the aged 12~22 groups ($P < 0.05$) (Figure 2-2-1-40).

The DBP of male and female students fluctuated in a slow upward trend as age increased between ages 6~16. The DBP of female students decreased mildly after age 16, while that of male student remained almost constant after age 18. The average DBP was ranged from 62.1~73.2mmHg for males and 63.2~70.9mmHg for females (Table 3-2-4-3). The DBP of male students was lower than that of female students at ages 6~8, 10, 11,

13, with significant gender difference only found at age 8 ($P < 0.05$); whereas the DBP of male students was higher than that of female students at ages 9, 14~22, with significant gender difference only found at age 17 ($P < 0.05$). No difference was significant between gender in other age groups (Figure 2-2-1-41).

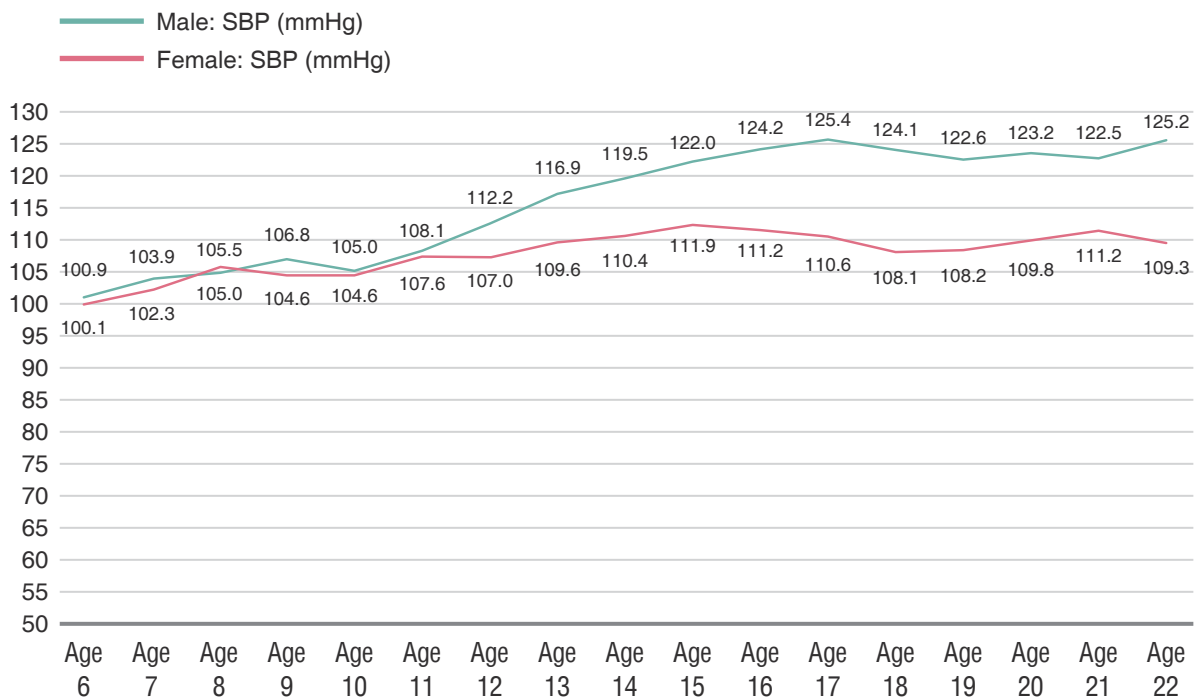

Figure 2-2-1-40 Average SBP of students

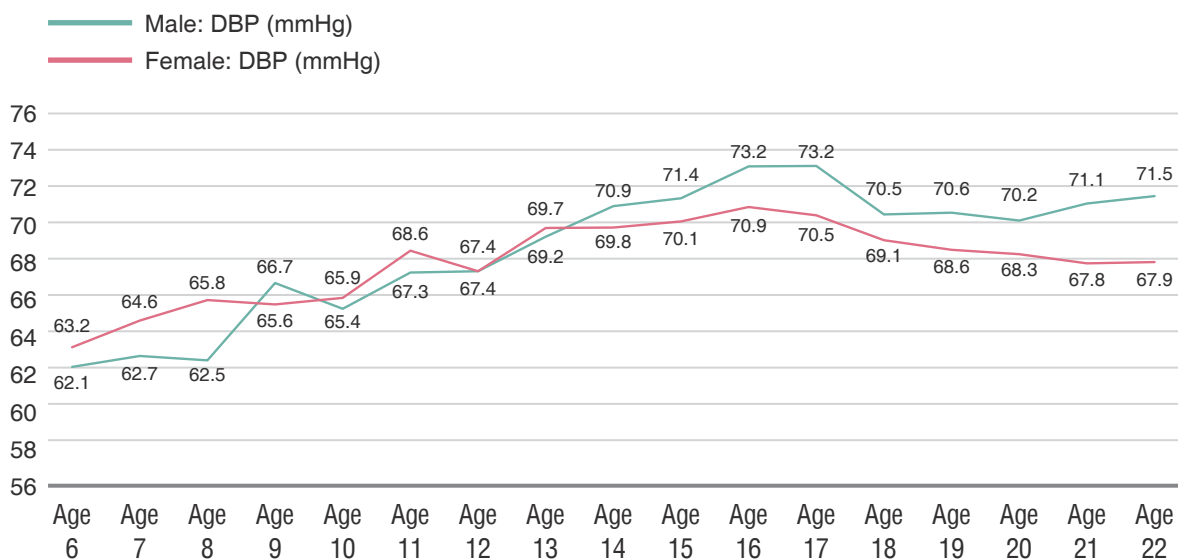

Figure 2-2-1-41 Average DBP of students

The average pressure difference of male students aged 6~22 was increasing with advancing age, and that of female students remained fairly stable after age 8. The average pressure difference was ranged from 38.7~53.7mmHg for males and 36.9~43.6mmHg for females (Table 3-2-4-4). The pressure difference of male students was higher than that of female students, with no significant difference found in the aged 6, 9~11 groups, but it differed significantly between gender in the aged 7, 8, 12~22 groups ($P < 0.05$) (Figure 2-2-1-42).

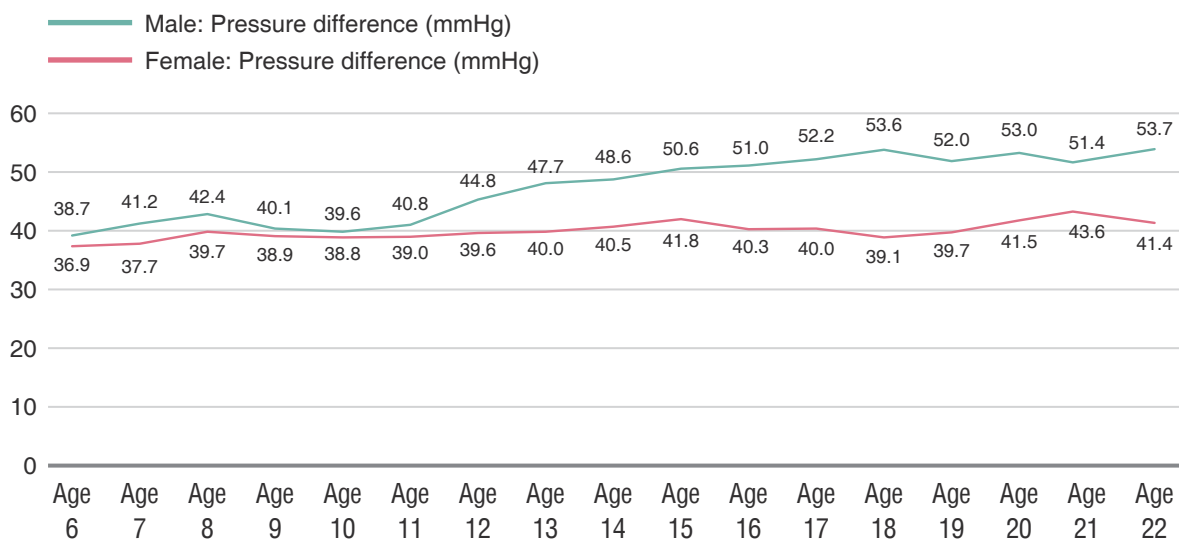

Figure 2-2-1-42 Average pressure difference of students

4.3 Vital Capacity

Vital capacity refers to the maximum amount of air that can be exhaled after a maximum inhalation. This indicates the maximum working capacity of the respiratory system of human body.

The average vital capacity of students aged 6~22 increased with advancing age, with a greater increase in rate between ages 6~15 for males and 6~12 for females, and the increase was slowed down thereafter. The average vital capacity was ranged from 915.7~4163.1ml for males and 858.9~2806.0ml for females, which was peaked at age 22 and 20 for males and females, respectively (Table 3-2-4-5). The vital capacity of male students was higher than that of female students, with significant difference between gender found at age 8, 9, 12~22 ($P < 0.05$). No significant gender difference was found in other age groups (Figure 2-2-1-43).

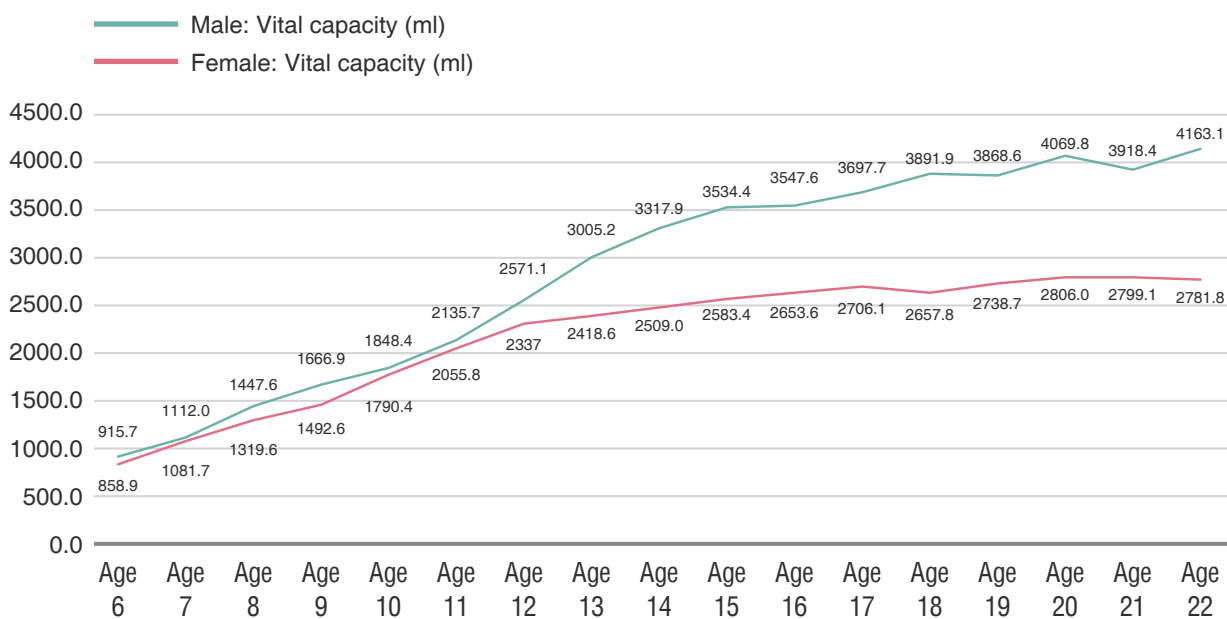

Figure 2-2-1-43 Average vital capacity of students

The average vital capacity/weight of male students aged 6~22 fluctuated in an upward trend with advancing age, and that of females students remained steady after age 9. The average vital capacity/weight of males students was ranged from 40.7~62.6 (ml/kg), reaching the peak in the aged 22 group; while that of female students was ranged from 40.4~52.1 (ml/kg), reaching the peak in the aged 17 group (Table3-2-4-6). The average vital capacity/weight of males was higher than that of females, which differed significantly between gender in the aged 8, 13~22 groups ($P < 0.05$). No significant difference between gender was found in other age groups (Figure 2-2-1-44).

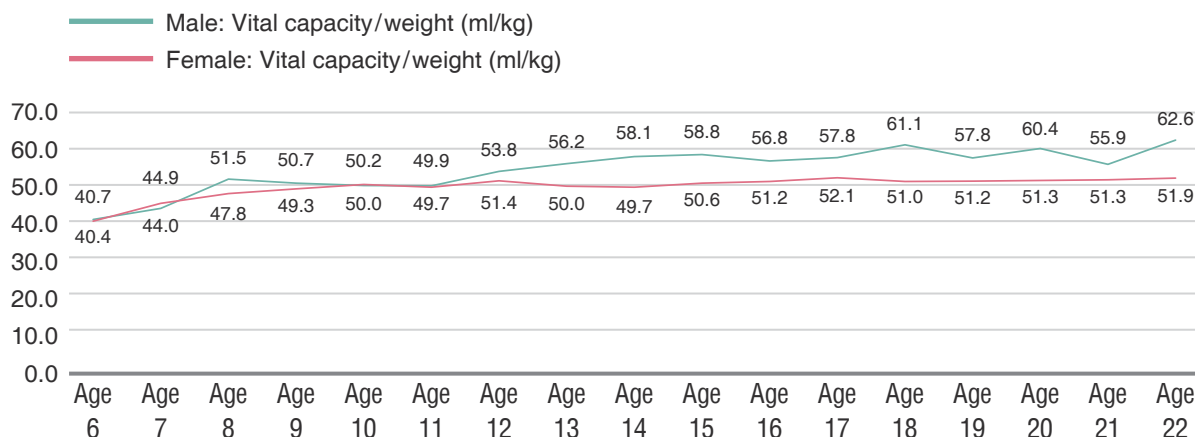

Figure 2-2-1-44 Average vital capacity / weight of students

5. Physical Fitness

5.1 Speed

50m run was used to reflect the speed of students.

The average time of 50m run for male and female students was ranged from 7.9~12.8 seconds and 9.6~13.0 seconds, respectively. The longest time was found at age 6 for both male and female students. The fastest running speed of males and females were 7.9 seconds recorded at age 18 and 9.6 seconds recorded at age 15, respectively (Table 3-2-5-1). It showed that the speed of students increased with advancing age. Through comparison of data, speed of male students increased faster than that of females. Generally, males had faster speed than females, with significant gender difference observed in the aged 7, 8, 12~22 groups ($P < 0.05$) and no significant difference observed in other age groups (Figure 2-2-1-45).

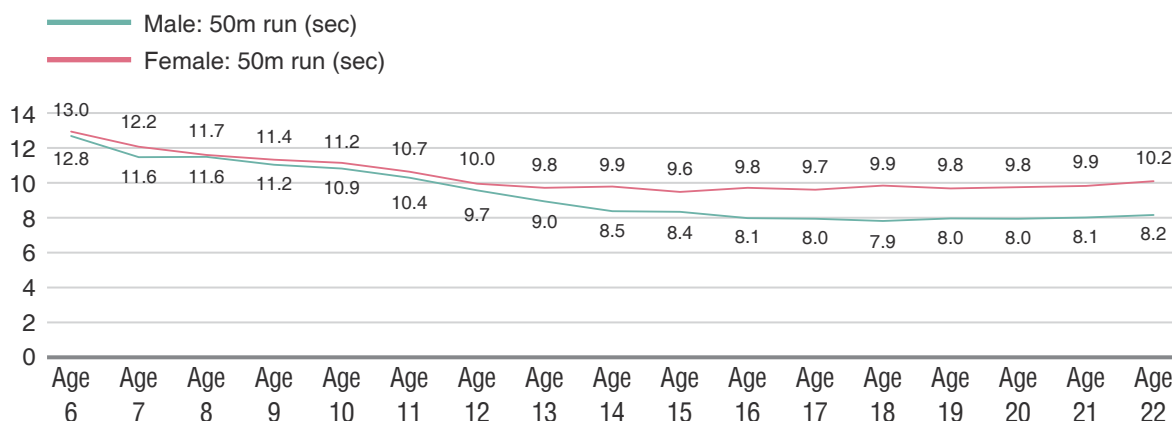

Figure 2-2-1-45 Average time of 50m run of student

5.2 Strength

Standing long jump, vertical jump, pull-ups (inclined pull-ups), one-minute sit-ups, grip strength and back strength were used to reflect strength of students. Standing long jump and vertical jump mainly reflect the explosive power; pull-ups (inclined pull-ups) and one-minute sit-ups mainly reflect muscle endurance; grip strength and back strength mainly reflect the maximum force that the muscle can exert.

Average indicators for male students were ranged as follows: standing long jump 102.1~197.4cm, vertical jump 18.7~41.2cm, pull-ups 0.6~2.6 times, inclined pull-ups 10.7~12.6 times, grip strength 7.8~40.4kg and back strength 25.5~107.2kg. Average indicators for female students were ranged as follows: standing long jump 98.1~145.9cm, vertical jump 18.4~27.6cm, one-minute sit-ups 11.8~29.1 times/minute, grip strength 7.2~24.3kg and back strength 23.2~61.7kg (Tables 3-2-5-2, 3-2-5-3, 3-2-5-4, 3-2-5-5 and 3-2-5-6).

All indicators of students increased with advancing age, but the degree of increase differed in each indicator. The strength of males increased faster than that of females, and the strength of females increased relatively slower with advancing age. By contrast, all aspects in strength were stronger in males than females and the rate of increase in males was greater than females as well. The study results showed that significant difference between gender was observed in the average distance of standing long jump in all age groups except the aged 9, 10 groups ($P < 0.05$); it was also observed in the average distance of vertical jump in the aged 7, 10~22 groups ($P < 0.05$), but not in other age groups; as for the average grip strength, it differed significantly between gender in students aged 6~9 and 12~22 ($P < 0.05$), but not in other age groups; in addition, the significant difference between gender was seen in the average back strength in all age groups ($P < 0.05$) (Figures 2-2-1-46, 2-2-1-47, 2-2-1-48, 2-2-1-49 and 2-2-1-50).

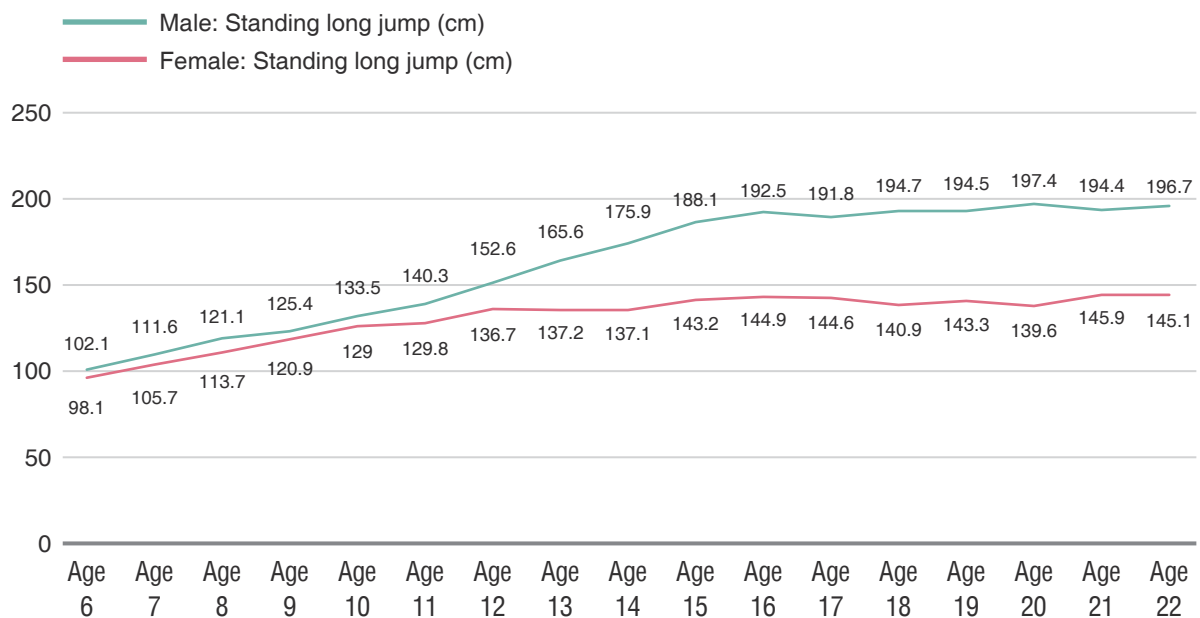

Figure 2-2-1-46 Average distance of standing long jump of students

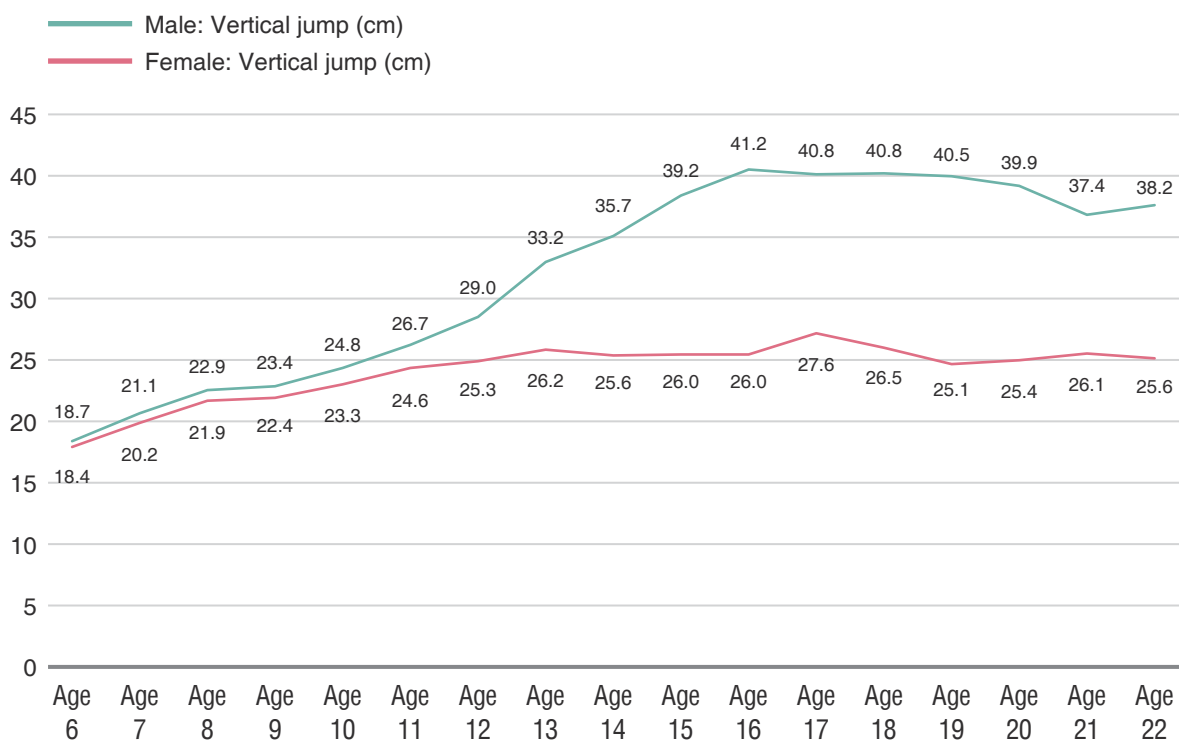

Figure 2-2-1-47 Average distance of vertical jump of students

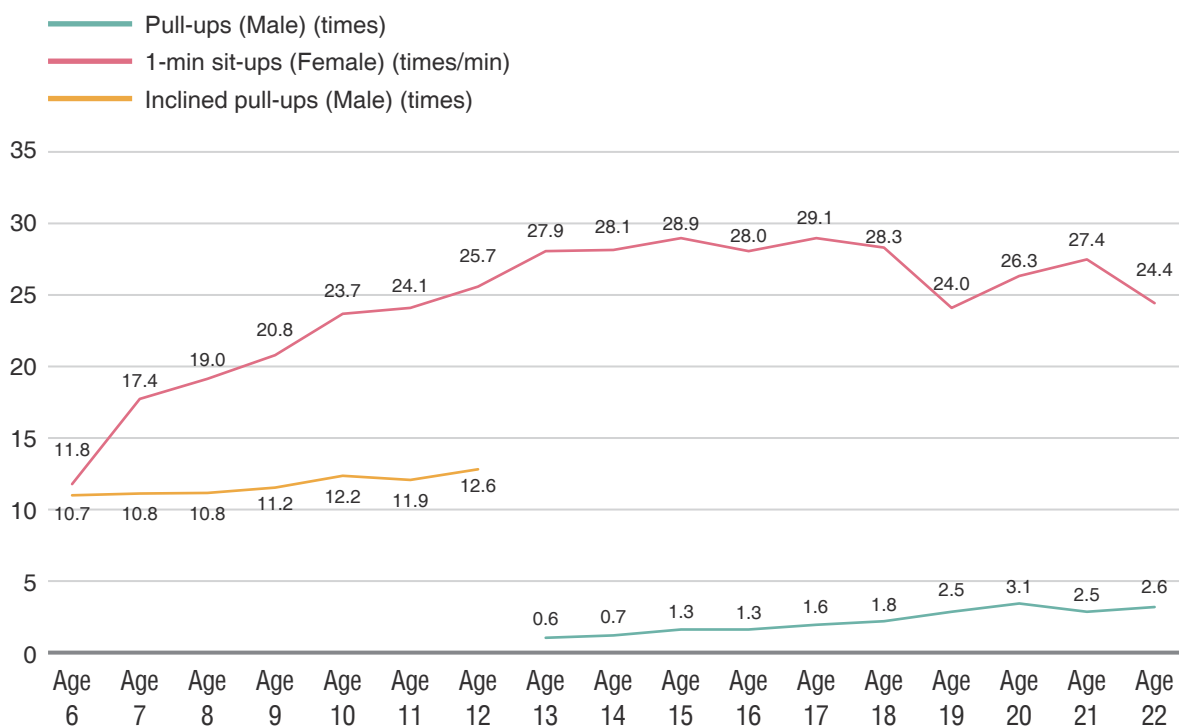

Figure 2-2-1-48 Average pull-ups, inclined pull-ups and 1-minute sit-ups of students

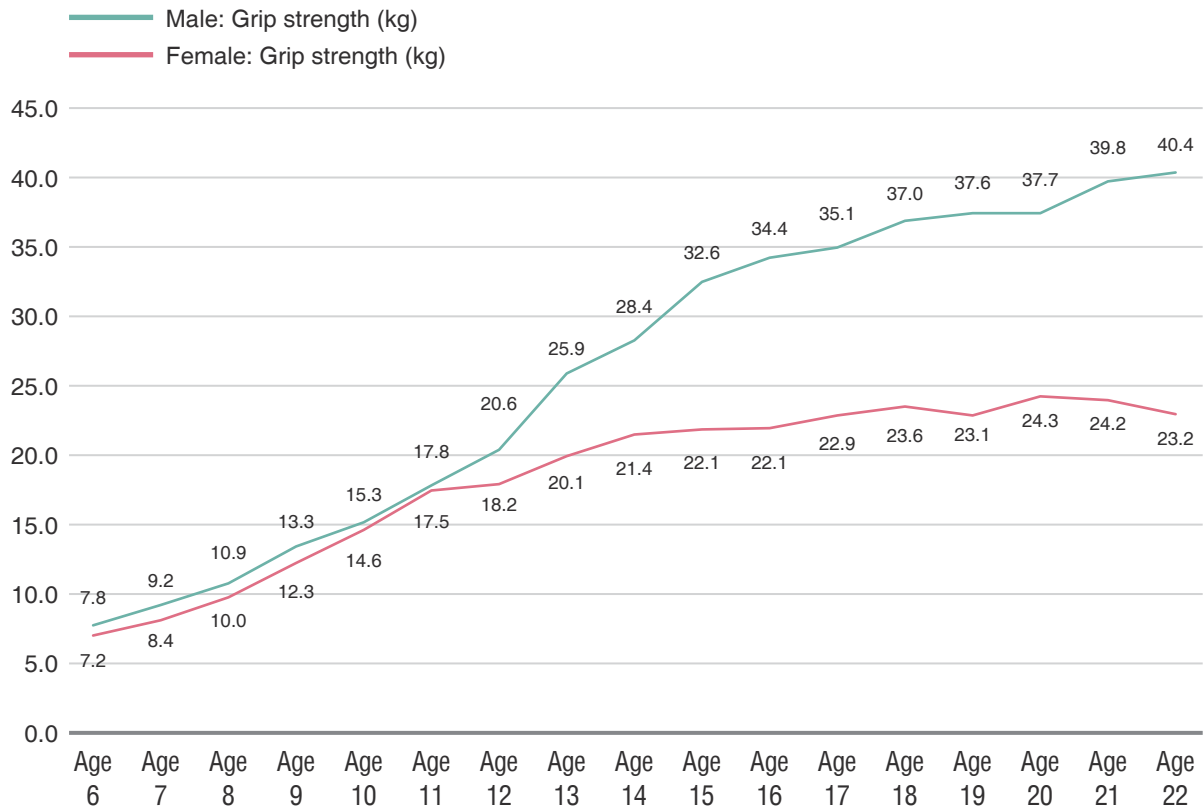

Figure 2-2-1-49 Average grip strength of students

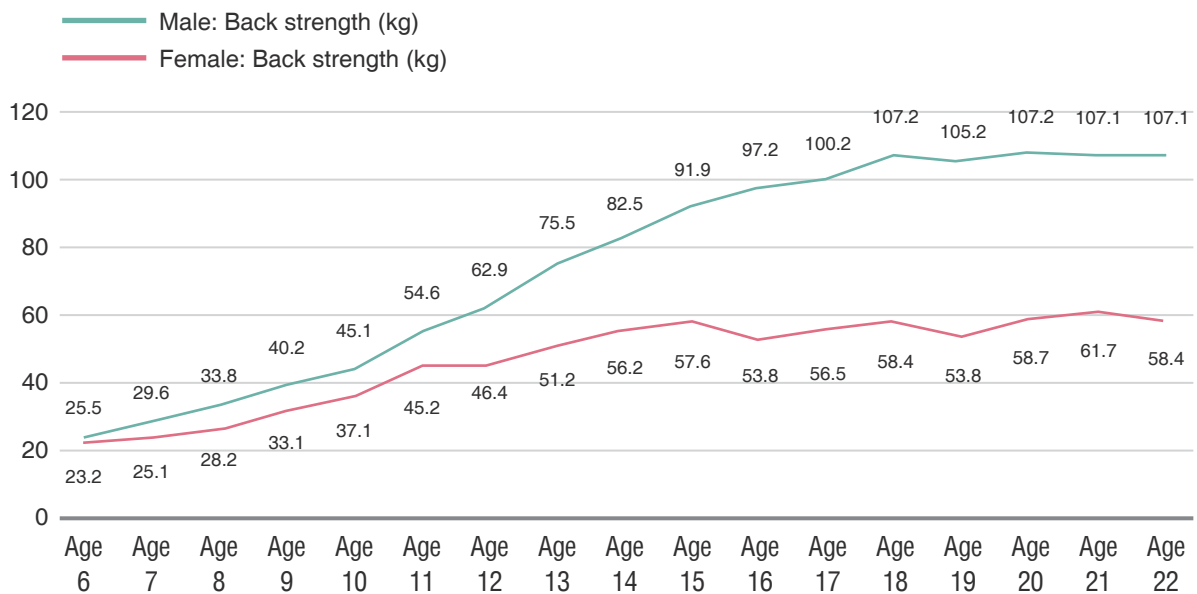

Figure 2-2-1-50 Average back strength of students

5.3 Endurance Run

The endurance of students aged 6~12 was reflected by the 50m×8 shuttle run, while the endurance of male students aged 13~22 was reflected by 1,000m run and the endurance of female students aged 13~22 was reflected by 800m run.

The average time for male students to finish 50m×8 shuttle run and 1,000m run was ranged from 127.5~151.6 seconds and 304.4~348.1 seconds, respectively. The average time for female students to finish 50m×8 shuttle run and 800m run was ranged from 130.0~153.6 seconds and 275.1~297.5 seconds, respectively (Table 3-2-5-7).

The endurance of males increased with advancing age before age 18, while that of females increased with advancing age before age 15. Afterwards, the endurance of both gender tended to decrease as age increased. The average time for male students to finish 50m×8 shuttle run was less than that for female students in the aged 6~12 groups, with no significant difference seen (Figures 2-2-1-51 and 2-2-1-52).

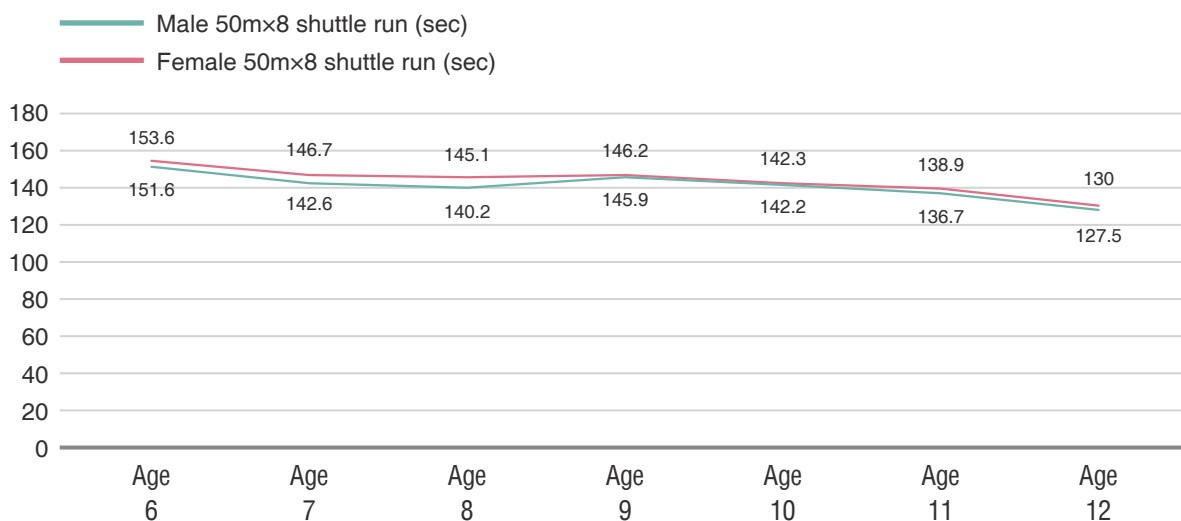

Figure 2-2-1-51 Average time of endurance run of students (children)

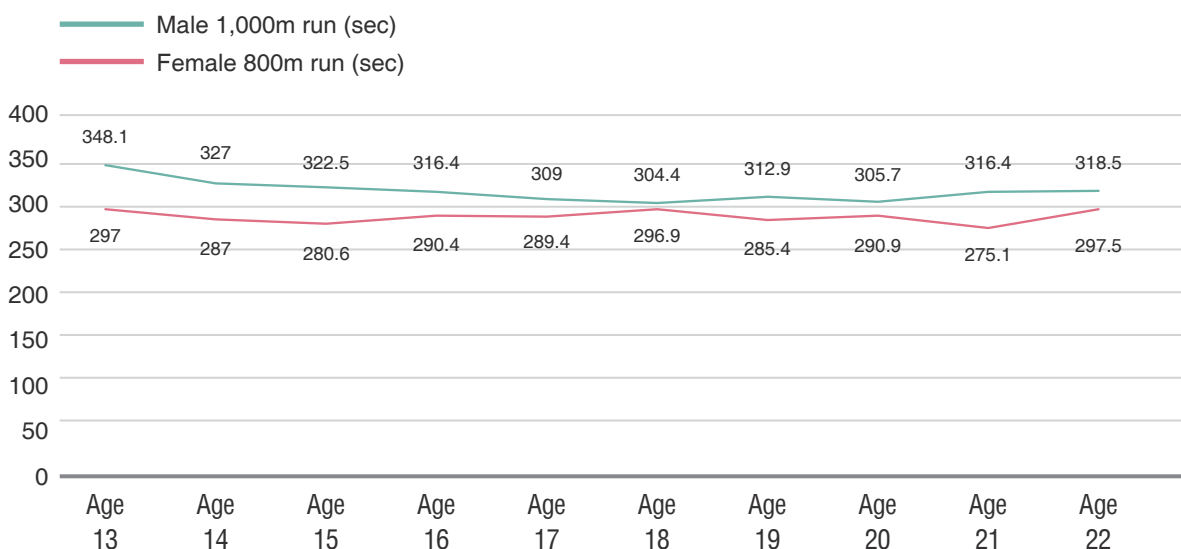

Figure 2-2-1-52 Average time of endurance run of students (adolescents)

5.4 Flexibility

Sit and reach was used to reflect flexibility.

The average distance of sit and reach of male and female students was ranged from 0.3~4.4cm and 5.3~10.5cm, respectively (Table 3-2-5-8). The flexibility of males decreased between ages 6~10, and tended to increase slightly after ages 10~14. The flexibility of females fluctuated with advancing age and remained fairly stable. By contrast, females had better flexibility than males, and the difference was significant between gender in the aged 6~21 groups ($P < 0.05$), but not in the aged 22 group (Figure 2-2-1-53).

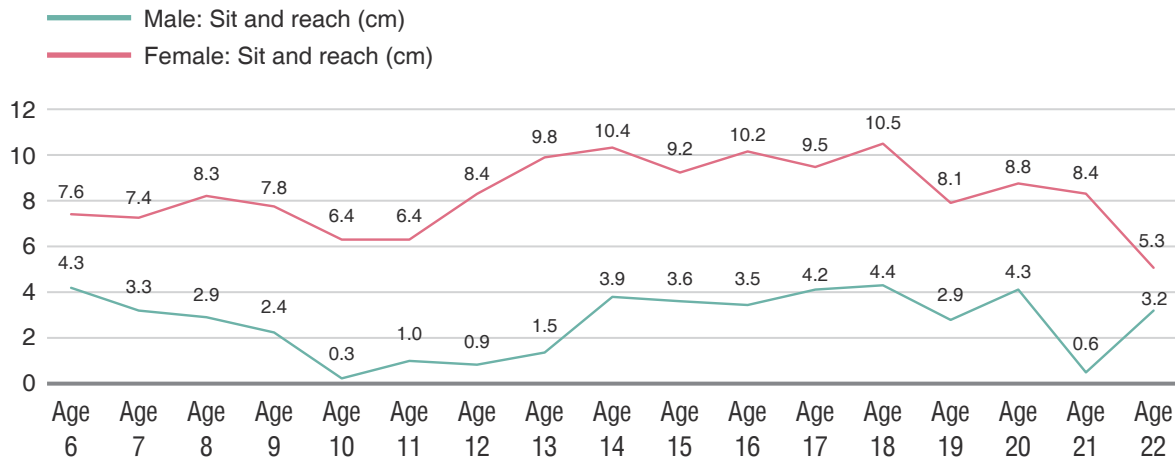

Figure 2-2-1-53 Average distance of sit and reach of students

5.5 Reaction

Choice reaction time was used to reflect the ability to react. The average choice reaction time of male and female students was ranged from 0.37~0.60 second and 0.40~0.61 second, respectively (Table 3-2-5-9). The reaction of both gender was improved with advancing age. Male students had better reaction than female students, and the difference was significant between gender in the aged 9, 11~21 groups ($P < 0.05$), but not in other age groups (Figure 2-2-1-54).

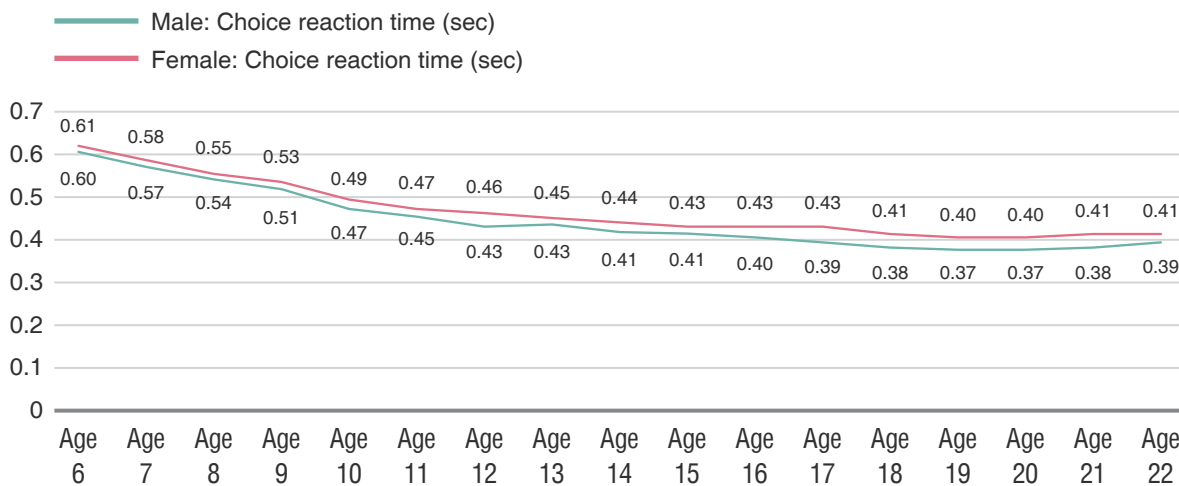

Figure 2-2-1-54 Average choice reaction time of students

5.6 Balance

One foot stands with eyes closed (OFSEC) was used to reflect balance.

The average OFSEC time of males and females was ranged from 13.8~44.9 seconds and 17.6~55.4 seconds, respectively (Table 3-2-5-10). The balance of males kept increasing with advancing age and the increase was almost tripled. The balance of females increased with advancing age before age 15 and the increase was also tripled. In general, the balance of females was slightly better than that of males, with no significant difference seen in the aged 10~13, 16~22 groups, but it was differed significantly between gender in the aged 6~9, 14 and 15 groups ($P < 0.05$) (Figure 2-2-1-55).

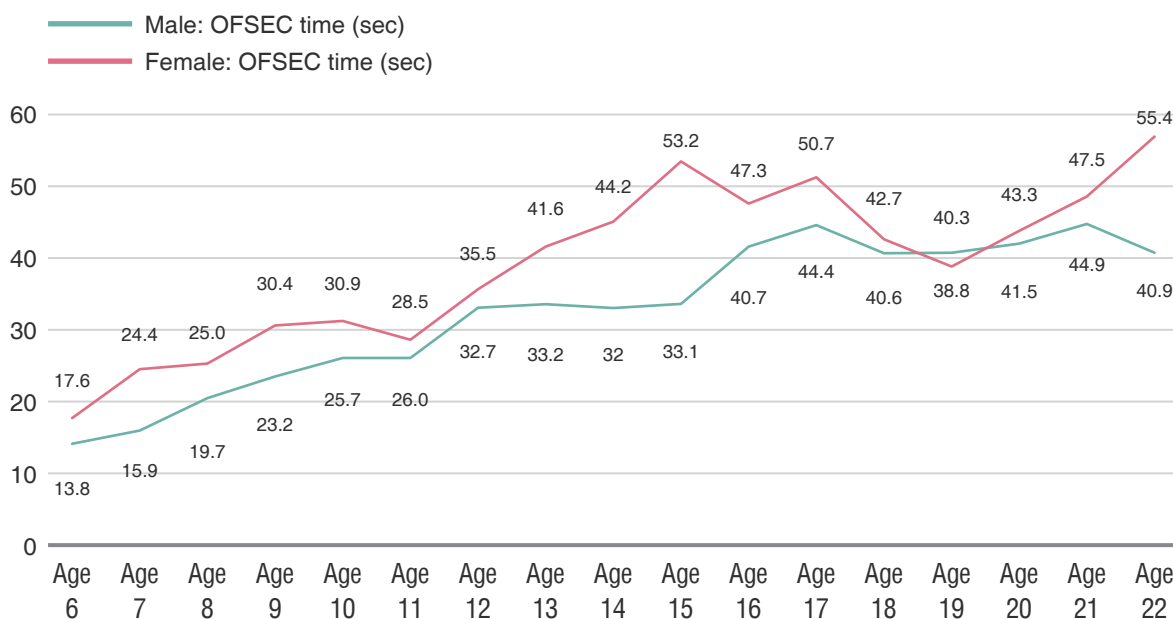

Figure 2-2-1-55 Average OFSEC time of students

6. Teeth

6.1 Occurrence of Decayed Primary Teeth

Dental decay of primary teeth among male and female students occurred mainly between ages 6~12. With the replacement of primary teeth by permanent teeth, the prevalence of decayed primary teeth declined to nearly 0% after age 14 except few age groups.

The prevalence of decayed primary teeth in male and female students varied in similar ways. The prevalence in both males and females showed a first increased and then decreased trend with advancing age, reaching a peak of 66.4% at age 7 for males, and a peak of 68.6% at age 7 for females. The prevalence of decayed primary teeth was ranged from 0.0%~66.4% for males and 0.0%~68.6% for females (Table 3-2-6-1). No significant difference between gender was observed in each age group (Figure 2-2-1-56).

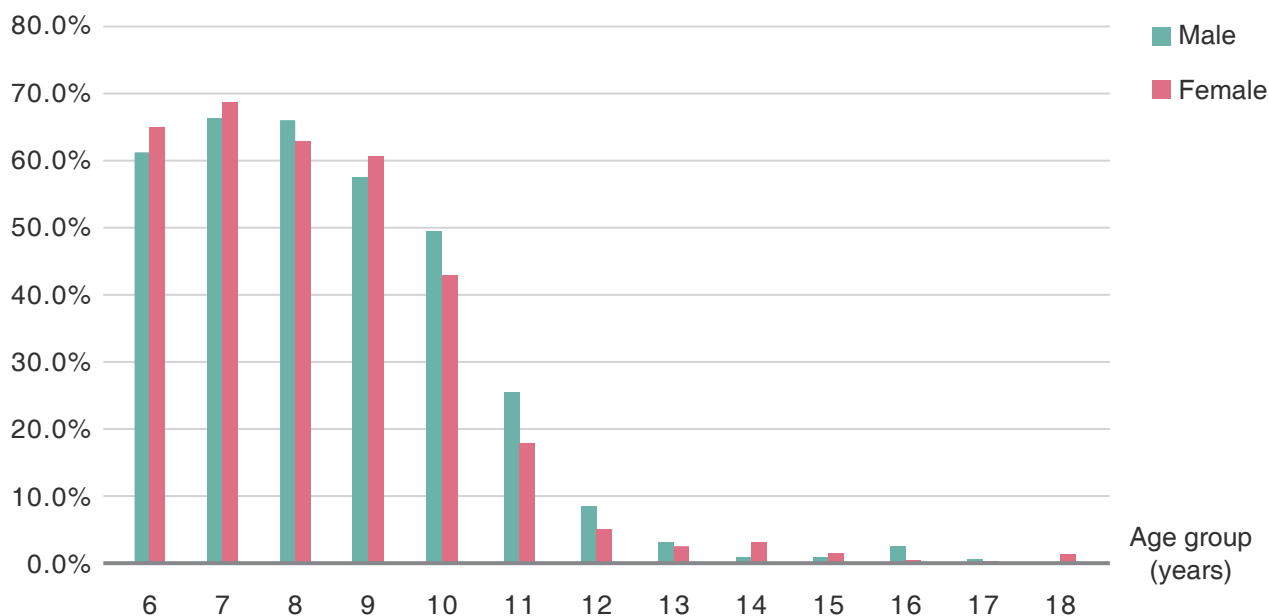

Figure 2-2-1-56 Prevalence of decayed primary teeth in students

The prevalence of filled primary teeth of students showed a first increased and then decreased trend with advancing age. The prevalence of males and females both reached a peak at age 8, with 47.5% in males and 47.1% in females. The prevalence of filled primary teeth in male and female students was ranged from 0.0%~47.5% and 0.0%~47.1%, respectively (Table 3-2-6-1). The prevalence of filled primary teeth of male students was higher than that of female students in the aged 11, 15 and 18 groups; whereas that of female students aged 13 was higher than that of male students of the same age, with significant difference observed ($P < 0.05$) (Figure 2-2-1-57).

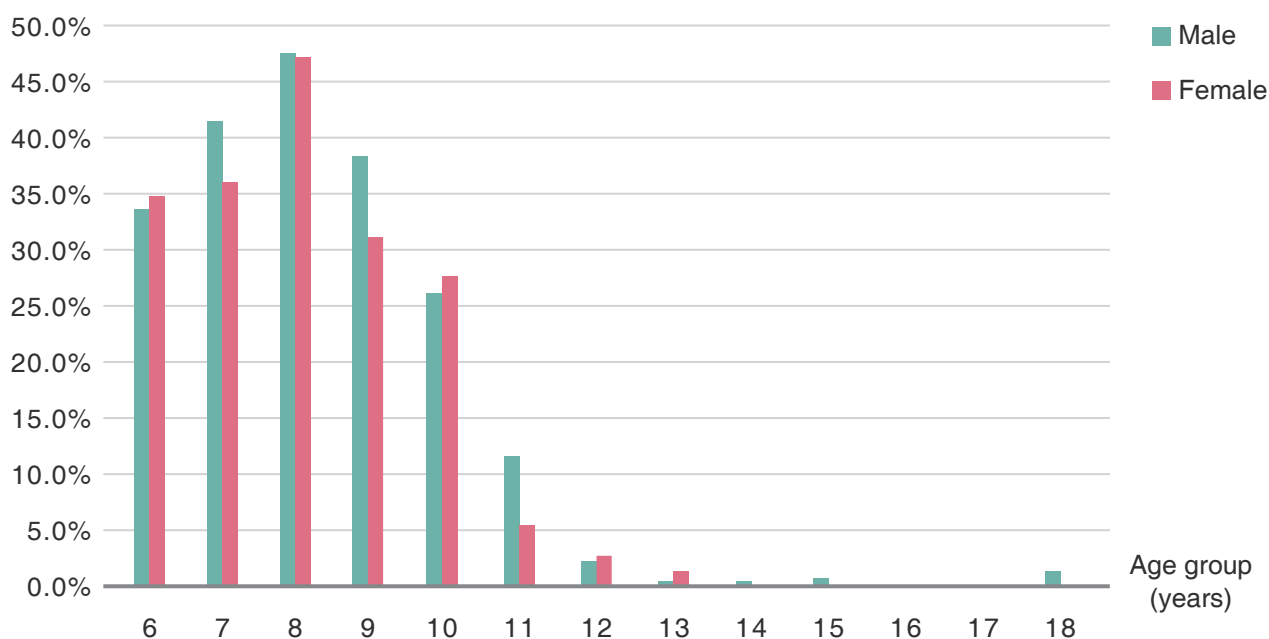

Figure 2-2-1-57 Prevalence of filled primary teeth in students

The prevalence of missing primary teeth in students showed a first increased and then decreased trend with advancing age. The prevalence of male and female students both reached a peak at age 7, with 4.6% in males and 7.6% in females. Afterwards the prevalence tended to decline with advancing age, and it was decreased to 0 in male students aged 11 and onwards and female students aged 10 and onwards (Table 3-2-6-1). By contrast, the prevalence of missing primary teeth of male students was higher than that of female students in the aged 9~11 groups; whereas that of female students was higher than that of male students in the aged 6~7 groups, with significant difference ($P < 0.05$) (Figure 2-2-1-58).

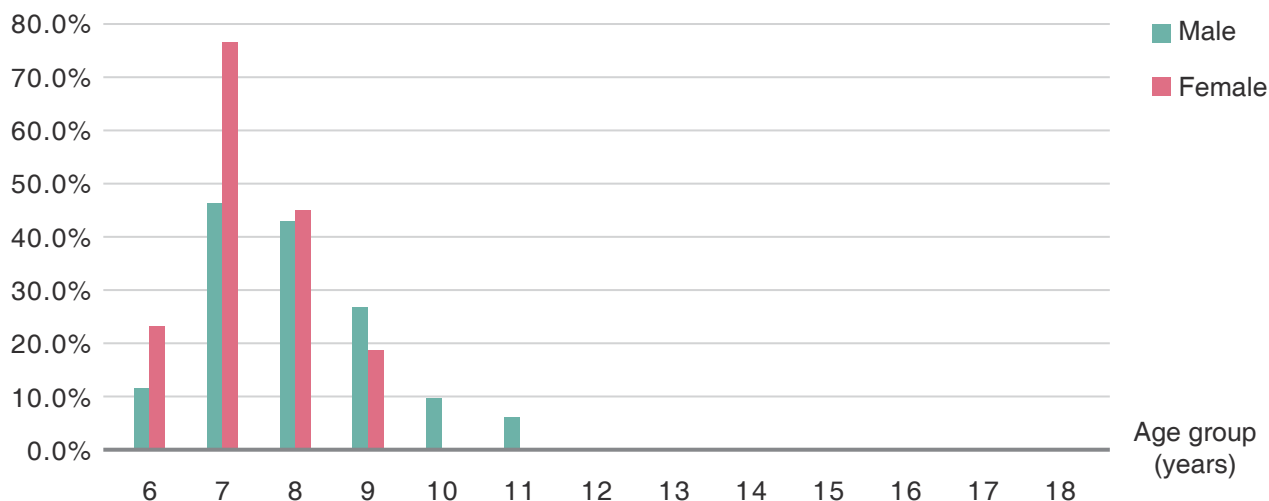

Figure 2-2-1-58 Prevalence of missing primary teeth in students

The prevalence of decayed-missing-filled (dmf) primary teeth in students showed a first increased and then decreased trend, reaching a peak of 80.5% in male students aged 8 and a peak of 80.8% in female students aged 7. The prevalence of dmf primary teeth in males and females was ranged from 0.0%~80.5% and 0.0%~80.8%, respectively (Table 3-2-6-1). In general, it was found that the prevalence of dmf primary teeth of male students was higher than that of female students in the aged 11~12, 15~17 groups; whereas that of female students was higher than that of male students in the aged 14, 18 groups, with significant difference observed ($P < 0.05$) (Figure 2-2-1-59).

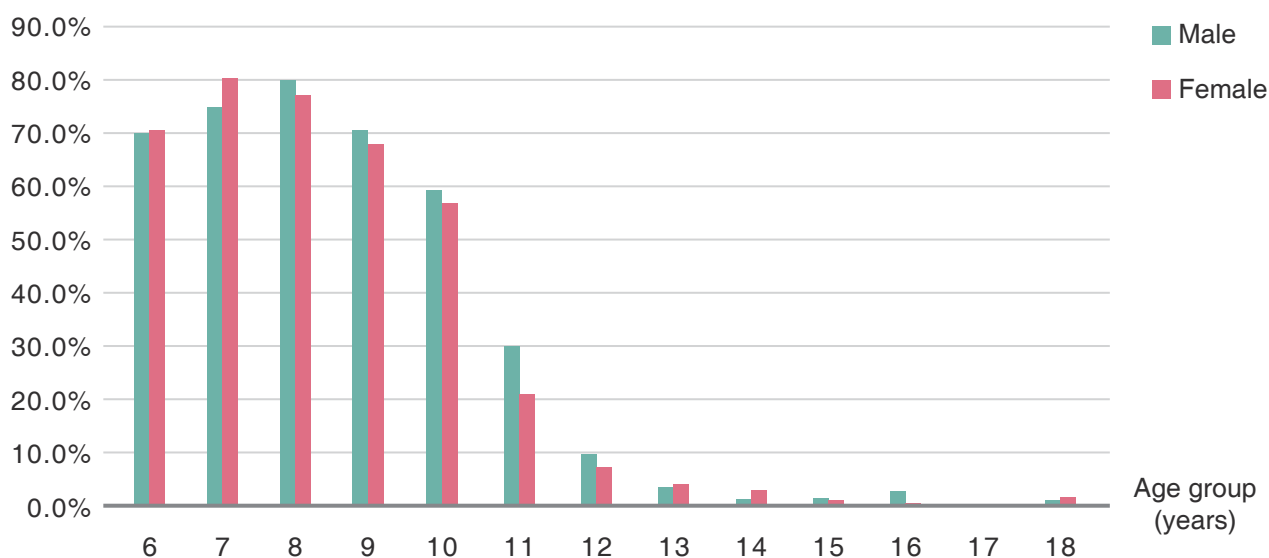

Figure 2-2-1-59 Prevalence of decayed-missing-filled (dmf) primary teeth in students

6.2 Occurrence of Decayed Permanent Teeth

Occurrence of decayed permanent teeth of students appeared at age 6, with the incidence rate accounting for 2.8% and 9.0% for males and females, respectively. The incidence rate fluctuated in an upward trend with advancing age, reaching a peak of 42.5% in males aged 16 and a peak of 49.0% in females aged 13. The prevalence of decayed permanent teeth in male and female students was ranged from 2.8%~42.5% and 9.0%~49.0%, respectively (Table 3-2-6-2). The prevalence of decayed permanent teeth in male students was lower than that in female students in the aged 6, 7, 8, 10, 12, 13 groups, with significant difference observed ($P < 0.05$) (Figure 2-2-1-60).

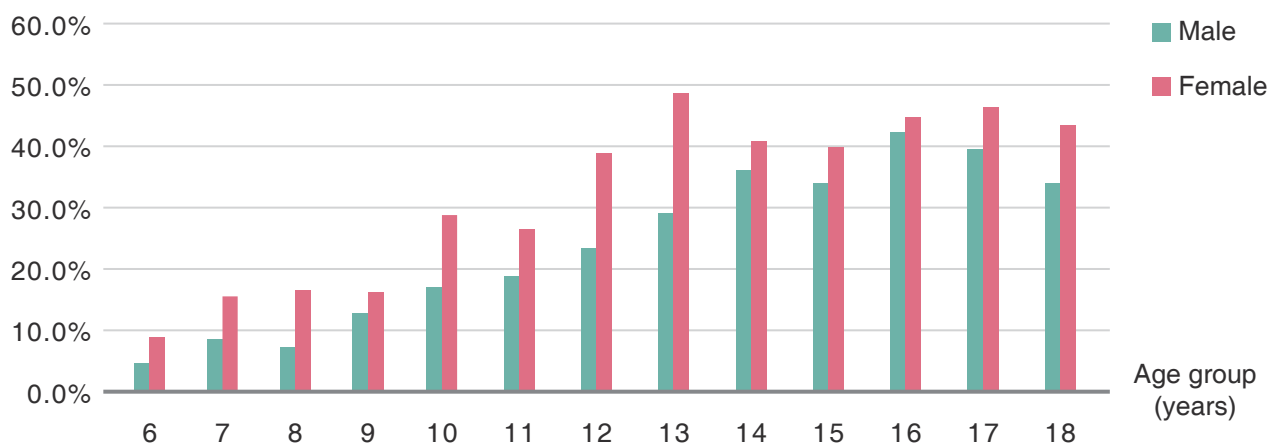

Figure 2-2-1-60 Prevalence of decayed permanent teeth in students

The prevalence of filled permanent teeth occurred at age 6 in male students and at age 7 in female students, accounting for 1.2% and 3.5%, respectively. Among ages 6~18, the prevalence in males fluctuated in an upward trend, reaching a peak of 35.5% at age 18. The prevalence in females fluctuated in the shape of S with advancing age, reaching a peak of 52.7% at age 18. The prevalence of filled permanent teeth of male and female students was ranged from 1.2%~35.5% and 3.5%~52.7%, respectively (Table 3-2-6-2). The prevalence of filled permanent teeth was higher in males than females at age 6, but lower than females at age 9, 13~18, and the difference was significant ($P < 0.05$) (Figure 2-2-1-61).

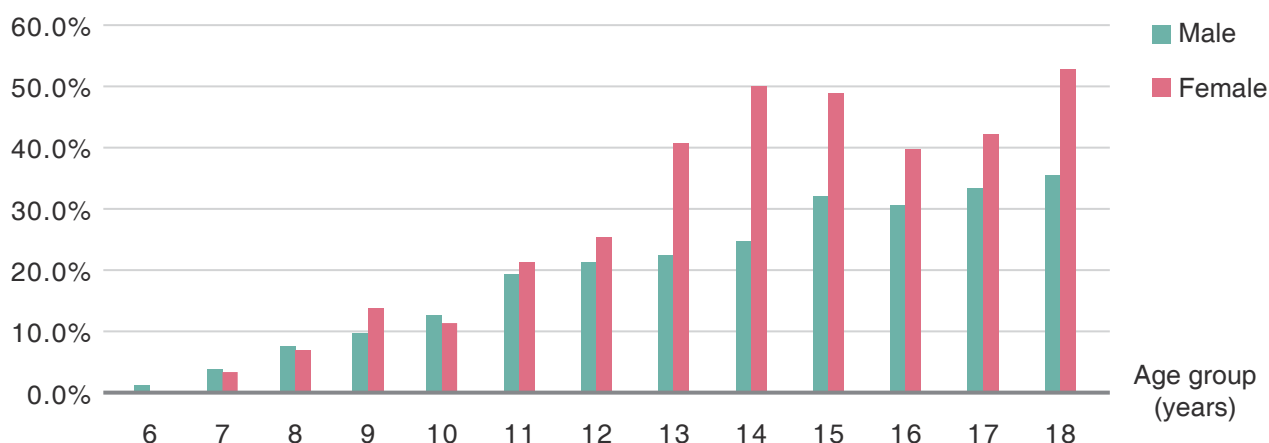

Figure 2-2-1-61 Prevalence of filled permanent teeth in students

The prevalence of missing permanent teeth occurred at age 6 among male students and at age 10 among females, accounting for 0.4% and 1.4% for males and females respectively. The prevalence in males fluctuated in S shape with advancing age, reaching a peak of 10.3% at age 16; and that of females varied irregularly. The prevalence of missing permanent teeth of male and female students was ranged from 0.0%~10.3% and 0.0%~21.9%, respectively (Table 3-2-6-2). The prevalence of missing permanent teeth was higher in males than females at age 6, 11, but lower than females at age 10, 12~17, with significant difference observed ($P < 0.05$) (Figure 2-2-1-62).

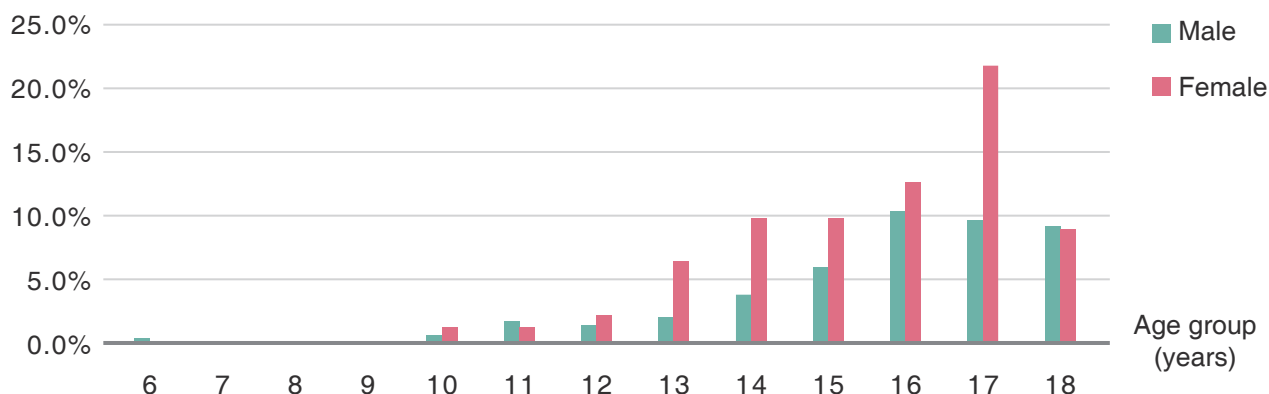

Figure 2-2-1-62 Prevalence of missing permanent teeth in students

The prevalence of decayed-missing-filled (DMF) permanent teeth occurred at age 6 for both genders, accounting for 4.4% and 9.0% for males and females respectively. The prevalence in males tended to increase with advancing age, reaching a peak of 62.6% at age 17. The prevalence in females tended to increase with advancing age, reaching a peak of 78.2% at age 18. The prevalence of DMF permanent teeth of male and female students was ranged from 4.4%~62.6% and 9.0%~78.2%, respectively (Table 3-2-6-2). By contrast, the prevalence of DMF permanent teeth was higher in females than males at age 6~8, 10, 12~15, 17~18, with significant difference observed ($P < 0.05$) (Figure 2-2-1-63).

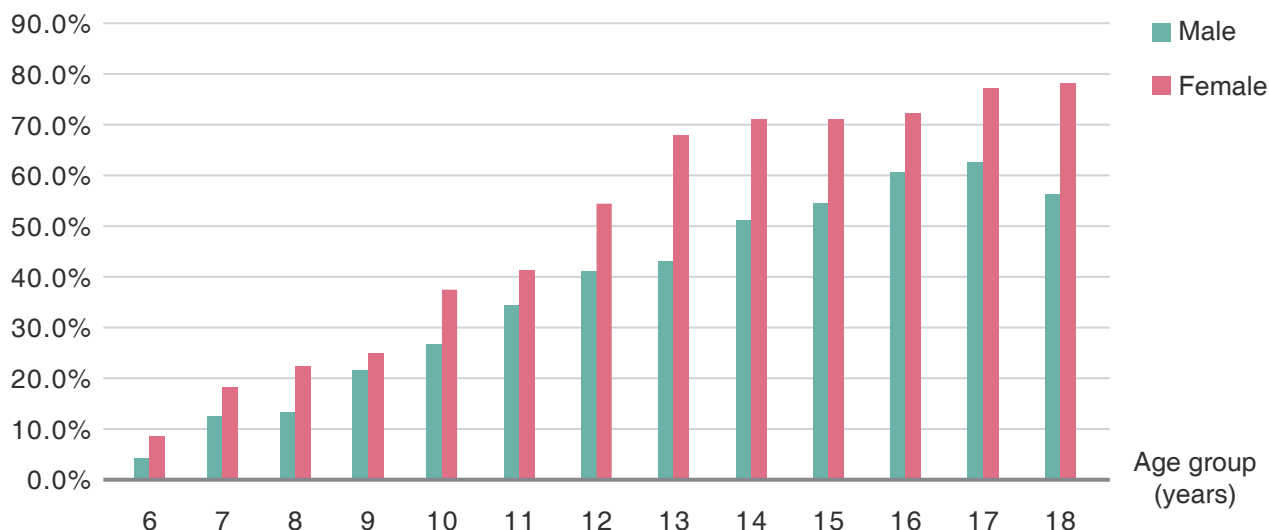

Figure 2-2-1-63 Prevalence of decayed-missing-filled (DMF) permanent teeth in students

7. Vision

7.1 Poor Vision

Poor vision is defined as a naked-eyes vision falling below 5.0. A naked-eye vision of 4.9 is considered as mild poor vision, while a naked-eye vision within 4.6~4.8 is considered as moderate poor vision and a naked-eye vision below or equal to 4.5 is considered as severe poor vision. Each subject was considered as a unit when doing the analysis. If the vision was different in both eyes, the one with poorer vision was used.

The proportion of male students with poor vision increased with advancing age between ages 6~17, which fluctuated first and then became stable afterwards. The proportion of male students with poor vision reached a peak of 82.6% at age 17, and a lowest proportion of 43.7% was recorded at age 6. The greatest increase of 11.3% was recorded between ages 11~12, and the proportion fluctuated at around 80% between ages 18~22. The proportion of poor vision in males was ranged from 43.7%~82.6% (Table 3-2-7-1, Figure 2-2-1-64).

The proportion of male students with mild poor vision reached a peak of 18.5% at age 6; those with moderate poor vision was more than 20% at age 9 and 12; and the proportion of those with severe poor vision increased quickly with advancing age, and was peaked at age 17 and 20, accounting for 67.9% and 65.1%, respectively. The proportion of male students with mild, moderate and severe poor vision was ranged from 1.9%~18.5%, 10.9%~22.3% and 7.6%~67.9%, respectively (Table 3-2-7-1).

Among female students aged 6~17, the proportion of those with poor vision increased with advancing age, which fluctuated first and then became stable afterwards. The proportion those with poor vision reached a peak of 89.5% at age 17, and a lowest proportion of 48.5% was recorded at age 6. The proportion remained at over 80% among ages 18~22. The proportion of poor vision in females was ranged from 48.5%~89.5% (Table 3-2-7-1, Figure 2-2-1-64).

The proportion of female students with mild poor vision was 22.2% at age 6, in which then showed a downward trend with advancing age, with fluctuation in between; the proportion of those with moderate poor vision fluctuated among age groups, with a maximum of 21.9% at age 9 and a minimum of 7.7% at age 19; the proportion of those with severe poor vision increased quickly with advancing age, reaching a maximum of 75.0% at age 17 and remaining at over 65% after age 18. The proportion of mild, moderate and severe poor vision in females was ranged from 2.5%~22.2%, 7.7%~21.9% and 7.0%~75.0%, respectively (Table 3-2-7-1).

It was indicated that except for the aged 12, 13, 15 and 19 groups, there was a higher proportion of female students with poor vision than males, with significant difference found in the aged 9 and 10 groups ($P < 0.05$) (Figure 2-2-1-64).

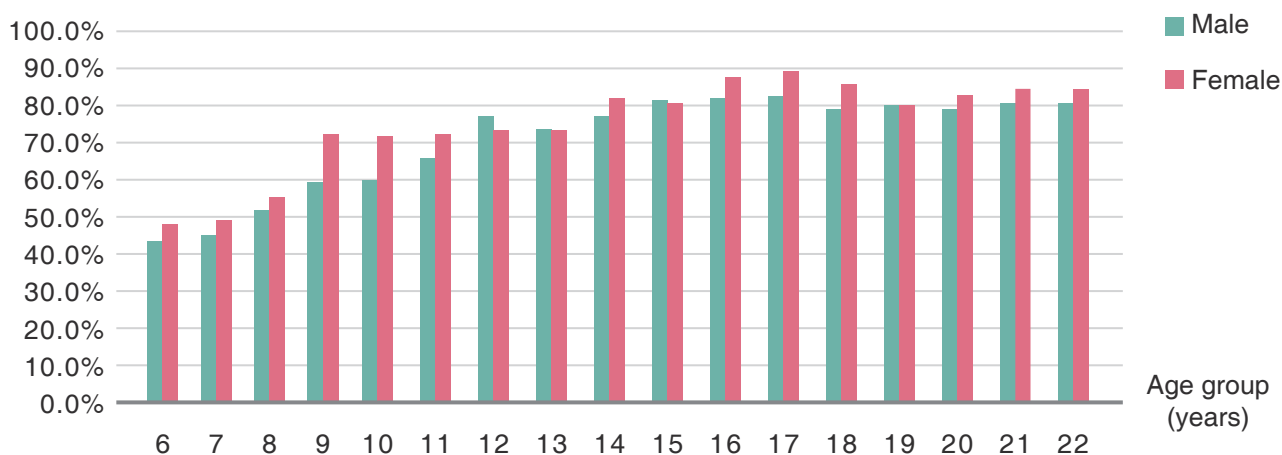

Figure 2-2-1-64 Proportion of students with poor vision

Retinoscopy was used to test for refractive error in subjects with poor vision. A subject is considered as nearsighted if his/her vision decreases with convex lens while improves with concave lens, In the study, the proportion of students with nearsightedness tended to increase with advancing age. With the exception of a decrease recorded at ages 12~13 and 15~16, the proportion of males with nearsightedness increased constantly between ages 6~17, with accelerated increasing rate recorded between ages 7~8, 8~9 and 11~12. The increasing rate slowed down after reaching a peak of 82.1% at age 17, but the proportion of students with nearsightedness still remained at a medium-high level of around 60%. The proportion of female students with nearsightedness fluctuated in an upward trend with advancing age between ages 6~22, reaching a peak of 87.3% at age 16 and remaining at a high level of around 80% between ages 14~22. The proportion of male and female students with nearsightedness was ranged from 42.0%~82.1% and 47.1%~87.3%, respectively. Except for the aged 12, 15 and 19 groups, females had a higher prevalence of nearsightedness than males, with significant difference found in the aged 9, 10, 21 and 22 groups ($P < 0.05$) (Figure 2-2-1-65).

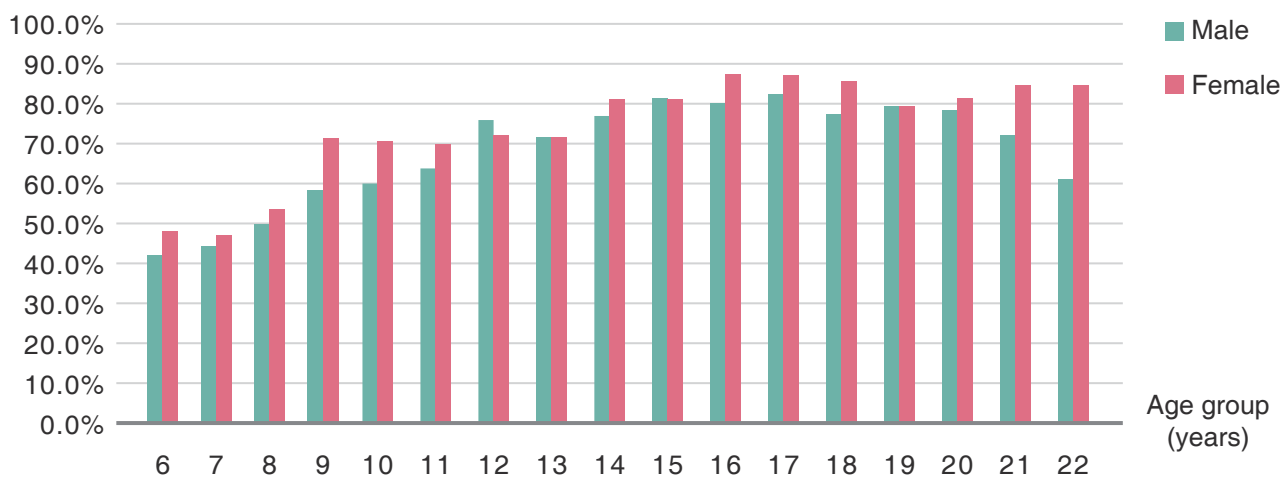

Figure 2-2-1-65 Proportion of students with nearsightedness

7.2 Color Vision

Color vision was used to reflect children and adolescents' ability to distinguish colors.

The proportion of students with abnormal color vision fluctuated among age groups. The proportion of female students with abnormal color vision tended to decrease with advancing age while a large difference was found in male students among age groups. Except for ages 6 and 9, the proportion of female students with abnormal color vision was obviously lower than that of males, with significant difference between gender observed among age groups ($P < 0.05$) (Table 3-2-7-2, Figure 2-2-1-66).

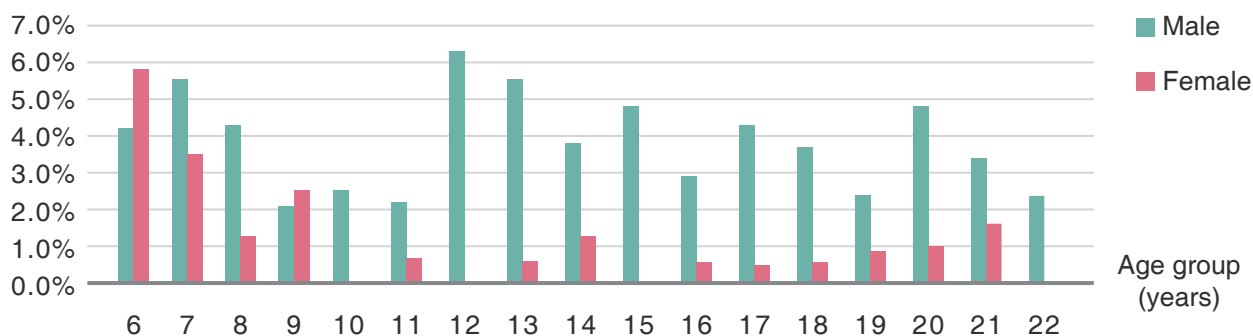

Figure 2-2-1-66 Proportion of students with abnormal color vision

(II) Comparison of 2020 and 2015 Results on the Physical Fitness Study of Macao Children and Adolescents (Students)

1. Overall Comparison of Children and Adolescents (Students) by Age

1.1 Comparison of Basic Information

5,335 and 5,235 subjects were drawn randomly in the 2020 and 2015 physical fitness study, respectively. The parishes in the two studies were consistent.

Comparing the birthplaces of students, both the 2020 and 2015 results showed that the birthplace order of students aged 6~12, 13~18 and 19~22 were Macao, Mainland China, Hong Kong and other countries (regions). The number of students born in Hong Kong and Mainland China increased, whereas those born in Macao decreased, and none was born in Portugal (Table 2-2-2-1).

Table 2-2-2-1 Comparison of birthplaces of students (%)

Gender	Birthplace	Year	Ages 6~12	Ages 13~18	Ages 19~22	Total	
Male	Mainland China	2015	10.6	19.7	11.2	14.3	
		2020	5.4	22.1	42.8	23.4	
	Macao	2015	83.9	75.9	85.6	81.0	
		2020	90.5	72.7	52.7	71.9	
	Hong Kong	2015	3.2	2.4	2.1	2.8	
		2020	3.4	3.1	2.1	2.9	
	Portugal	2015	0.0	0.1	0.0	0.0	
		2020	0.1	0.0	0.0	0.0	
	Others	2015	2.2	1.9	1.1	1.9	
		2020	0.6	2.1	2.4	1.7	
	Female	Mainland China	2015	13.0	24.6	21.7	19.0
			2020	7.3	26.1	44.2	25.8
		Macao	2015	81.0	72.0	76.1	76.7
			2020	87.4	67.7	50.6	68.6
Hong Kong		2015	3.4	2.0	1.8	2.6	
		2020	3.7	4.2	3.2	3.7	
Portugal		2015	0.0	0.0	0.0	0.0	
		2020	0.0	0.0	0.0	0.0	
Others		2015	2.3	1.9	0.9	1.9	
		2020	1.6	2.0	1.9	1.8	

1.2 Comparison of Lifestyle

In our study, the lifestyle of children and adolescents (students aged 6~22) which was examined encompassed 5 areas, namely, living habits, physical education classes at school, extracurricular physical exercises, occurrence of diseases and dental hygiene. Comparison of the results in 2020 and 2015 studies was as follows:

1.2.1 Living Habits

For living habits of students, information regarding 2 aspects was examined: average daily accumulated time spent on electronic devices and average daily sleep time (including naps).

In comparison of daily electronic device use in 2020 and 2015, there was significant difference found in secondary students ($P < 0.05$). The proportion of students who spent an average daily accumulated time of 3 hours or more on electronic devices increased tremendously, from 25.4% in 2015 to 53.4% in 2020 for males and from 22.4% in 2015 to 61.1% in 2020 for females (Table 2-2-2-2).

Table 2-2-2-2 Comparison of average daily time spent on electronic devices in secondary students (%)

Year	Time spent	Male	Female
2015	Less than 30 minutes	6.2	6.2
	30 minutes to 1 hour	16.7	17.5
	1~2 hours	32.8	33.4
	2~3 hours	18.8	20.4
	3 hours or more	25.4	22.4
2020	Less than 30 minutes	2.6	2.5
	30 minutes to 1 hour	6.0	5.3
	1~2 hours	18.5	15.3
	2~3 hours	17.8	15.5
	3 hours or more	53.4	61.1

In comparison of the average daily sleep time (including naps) in 2020 and 2015, the proportion of secondary students who had an average of less than 8 hours of sleep daily decreased significantly ($P < 0.05$), from 71.2% in 2015 to 45.9% in 2020. The proportion of university students who had an average of less than 8 hours of sleep daily also decreased significantly ($P < 0.05$), from 76.8% in 2015 to 54.6% in 2020 (Table 2-2-2-3).

Table 2-2-2-3 Comparison of average daily sleep time in students (%)

School age group	Year	Sleep time	%
Primary school	2015	Less than 8 hours	19.9
		8~10 hours	77.5
		10 hours or more	2.6
	2020	Less than 8 hours	10.6
		8~10 hours	73.2
		10 hours or more	16.2
Secondary school	2015	Less than 8 hours	71.2
		8~10 hours	27.4
		10 hours or more	1.4
	2020	Less than 8 hours	45.9
		8~10 hours	41.9
		10 hours or more	12.3
University	2015	Less than 8 hours	76.8
		8~10 hours	23.2
		10 hours or more	0.0
	2020	Less than 8 hours	54.6
		8~10 hours	39.5
		10 hours or more	5.9

1.2.2 Physical Education at School

Regarding the physical education (PE) classes at school, weekly frequency of attending PE classes and self-perception of exercise intensity of PE classes were examined.

Comparison of the 2020 and 2015 results showed a similar status of PE classes in primary students. The proportion of primary students who had 2 PE classes weekly accounted for 69.0% in 2020 and 71.9% in 2015; and those who had only 1 PE class weekly accounted for 30.5% in 2020 and 26.8% in 2015. During PE classes, primary students who were able to reach low, moderate and high exercise intensity were 16.5%, 67.5% and 16.0% in 2020 respectively; and 23.1%, 58.1% and 18.8% in 2015, respectively. In comparison, primary students had a higher proportion in reaching moderate exercise intensity in 2020 than in 2015, but a lower proportion in reaching low and high exercise intensity, with significant difference observed ($P < 0.05$) (Table 2-2-2-4).

According to the results of the two studies, secondary students had a similar status of weekly PE classes. The proportion of secondary students who had 2 PE classes weekly accounted for 39.6% in 2020 and 34.8% in 2015; and those who had only 1 PE class weekly accounted for 59.8% in 2020 and 61.8% in 2015. During PE classes, secondary students who were able to reach low, moderate and high exercise intensity were 8.1%, 70.8% and 21.0% in 2020 respectively; and 18.3%, 63.9% and 17.8% in 2015, respectively. Our study indicated that secondary students had a higher proportion in reaching moderate and high exercise intensity in 2020 than in 2015, but a lower proportion in reaching low exercise intensity, with significant difference observed ($P < 0.05$) (Table 2-2-2-4).

Table 2-2-2-4 Comparison of exercise intensity in primary and secondary students during PE classes (%)

School age group	Year	Exercise intensity	%
Primary school	2015	Low intensity	23.1
		Moderate intensity	58.1
		High intensity	18.8
	2020	Low intensity	16.5
		Moderate intensity	67.5
		High intensity	16.0
Secondary school	2015	Low intensity	18.3
		Moderate intensity	63.9
		High intensity	17.8
	2020	Low intensity	8.1
		Moderate intensity	70.8
		High intensity	21.0

1.2.3 Extracurricular Physical Exercises

In our study, 3 aspects on students' extracurricular physical exercises were examined, which were comprised of weekly exercise frequency, average exercise duration and intensity of physical exercises. Based on these three study indicators mentioned above, subjects who exercised 3 or more times weekly, with a duration more than 30 minutes each time and an exercise intensity reaching moderate or above level, were defined as "frequent exercisers". For those who did exercises but could not achieve all the above three criteria were defined as "occasional exercisers". Whereas those who did not meet any of the above criteria were defined as "non-exercisers".

The study results showed that the proportion of primary students who participated in extracurricular physical exercises increased by 8.4%, from 75.8% in 2015 to 84.2% in 2020, which differed significantly ($P < 0.05$). According to the definition of "frequent exercisers", the proportion of "frequent exercisers" among primary students who participated in extracurricular physical exercises increased from 11.8% in 2015 to 25.5% in 2020, which was an increase of 13.7% in 5 years and the difference was significant ($P < 0.05$).

Besides, the proportion of secondary students who participated in extracurricular physical exercises increased by 1.8% from 72.1% in 2015 to 73.9% in 2020. Among those participating in extracurricular physical exercises, the proportion of "frequent exercisers" accounted for 18.13% in 2020, which was basically the same as 18.06% in 2015.

1.2.4 Occurrence of Diseases

Among the student subjects, the proportion of students who had suffered from hospital-diagnosed diseases in the past 5 years increased by 15.3%, from 12.9% in 2015 to 28.2% in 2020, of which 28.5% were males (increased by 14.9% from 13.6% in 2015) and 27.9% were females (increased by 16% from 11.9% in 2015), and the difference was significant ($P < 0.05$).

1.2.5 Dental Hygiene

As shown in our study, the proportion of children and adolescents who brushed their teeth every day varied little in the two studies, with both staying above 90%; the proportion of those flossing their teeth increased from 6.8% in 2015 to 12.6% in 2020 among males and from 8.8% in 2015 to 15.3% in 2020 among females, with significant

difference observed ($P < 0.05$). Among students who acknowledged their dental problem, the proportion of those who had visited dental clinics for treatment increased from 67.5% in 2015 to 77.6% in 2020 in males; and from 72.8% in 2015 to 78.7% in 2020 in females, with significant difference observed ($P < 0.05$). It indicated that the awareness of dental care in children and adolescents had been slightly improved in the recent five years in Macao.

1.3 Comparison of Study Indicators

Compared with the results in 2015, the indicators such as weight, hip circumference, chest circumference, resting pulse, BMI and diastolic blood pressure of male students aged 6~22 increased in 2020, with a difference ranging from 1.0%~2.7%; the indicators of 50m run, standing long jump, vertical jump, OFSEC, vital capacity, aerobic endurance, grip strength and pull-ups decreased, with a difference ranging from 1.6%~11.3%; and other study indicators varied within 1.0% (Figure 2-2-2-1).

Compared with the results in 2015, the indicators such as shoulder width, sit and reach, pelvis width, sit-ups, chest circumference, hip circumference, diastolic blood pressure, systolic blood pressure, choice reaction time of female students aged 6~22 increased by 1.0%~3.3%; the indicators of BMI, back strength, vertical jump, vital capacity and grip strength decreased by 1.5%~4.5%; and other study indicators varied within 1.0% (Figure 2-2-2-2).

Due to the COVID-19 pandemic, the test of the student category was postponed from January 2020 to September 2020. Students were suspended from school and had stayed home for about half a year, during which their daily schedule was changed, and it had placed certain effects on the decline in most of physical fitness indicators.

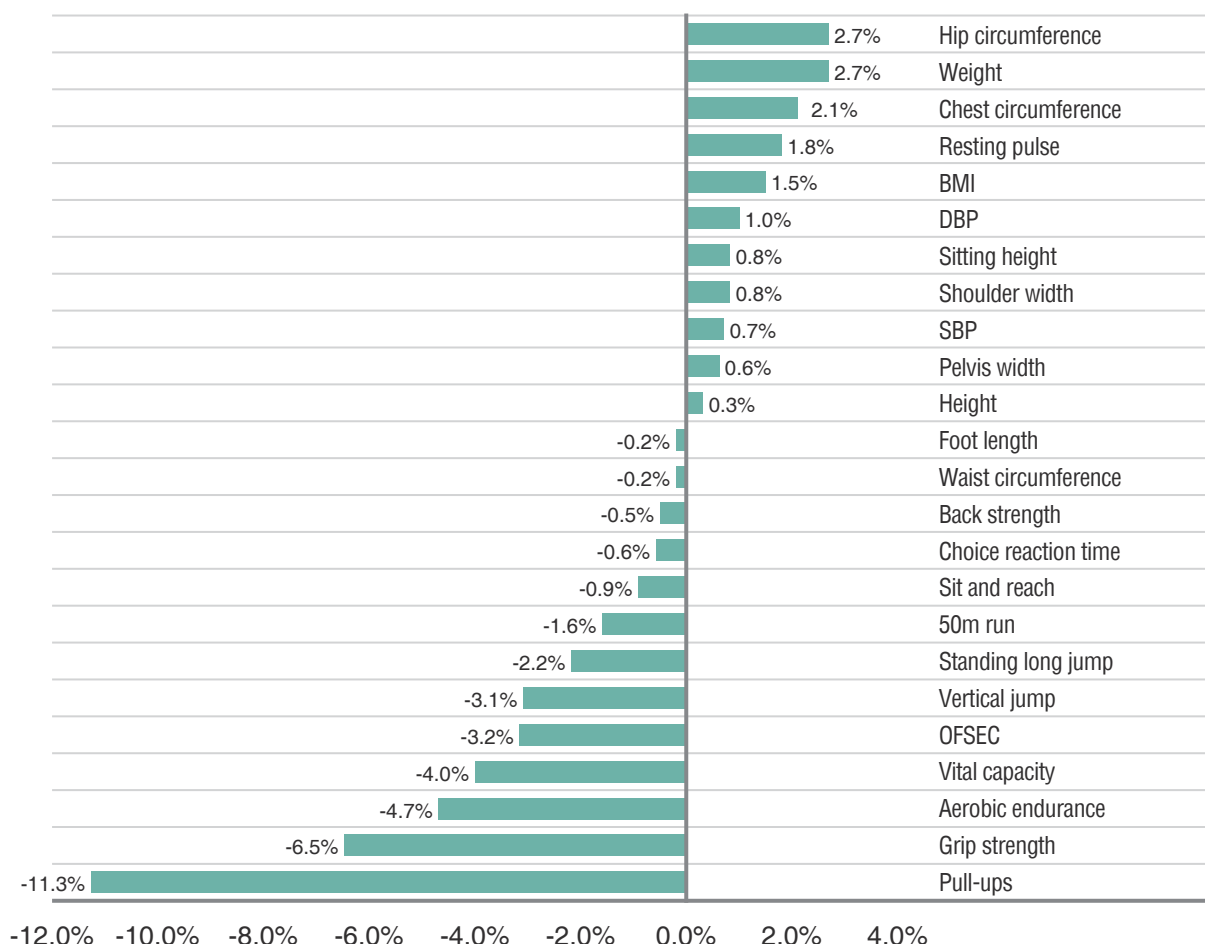

Figure 2-2-2-1 Comparison of 2020 and 2015 results in male students aged 6~22 (%)

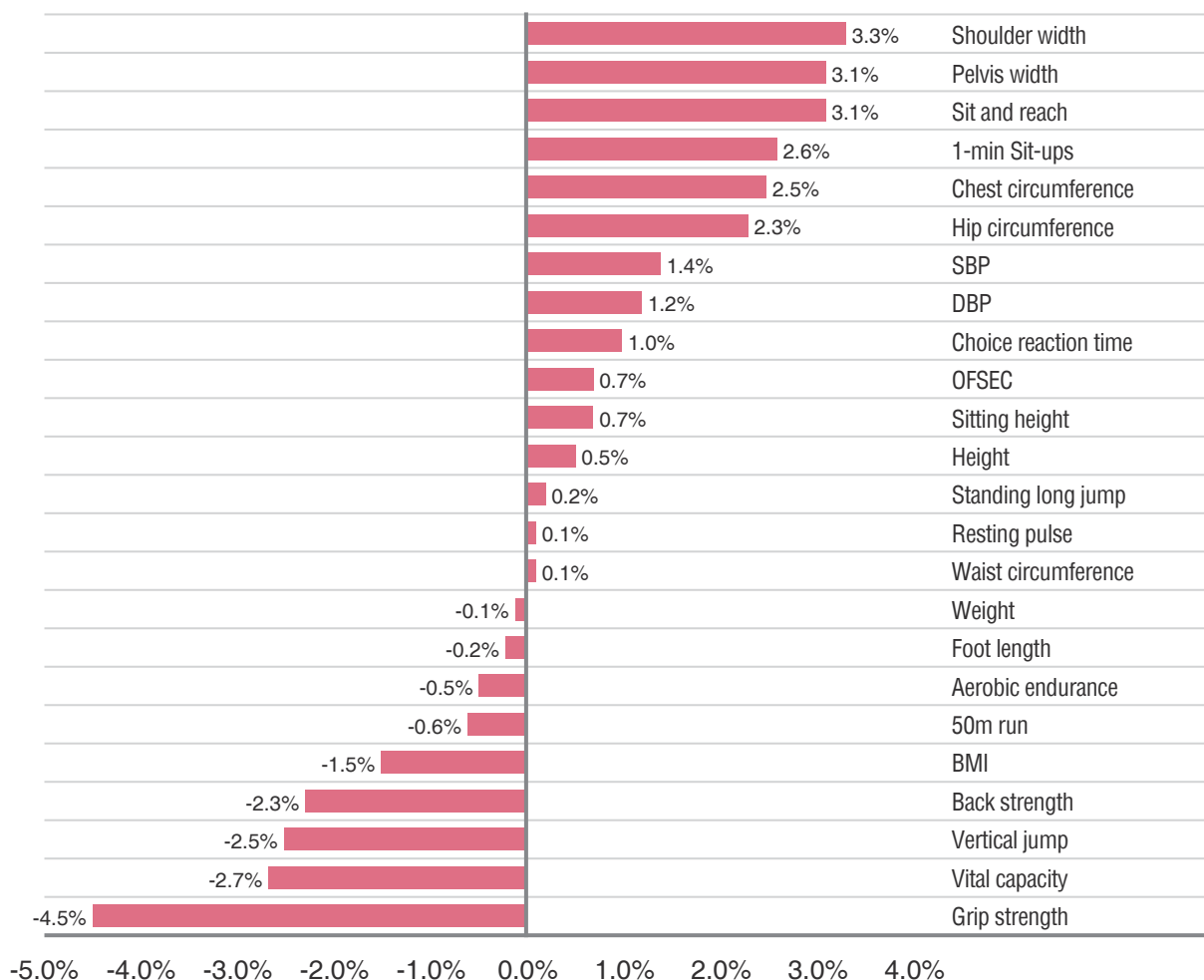

Figure 2-2-2-2 Comparison of 2020 and 2015 results in female students aged 6~22 (%)

2. Comparison of Children and Adolescents (Students) by Age

2.1 Comparison of Anthropometric Measurements

2.1.1 Length Indicators

Comparison of the 2020 and 2015 data showed that the average height of Macao students increased in most of the age groups with no statistically significant difference, and the difference recorded in each age group was ranged from -0.5~1.8cm and -0.6~1.8cm for male and female students, respectively. The average sitting height of students increased in most of the age groups with no statistically significant difference, and the difference was ranged from -0.3~1.5cm and 0~1.0cm for male and female students, respectively. The average foot length varied mildly between the two studies, with the difference ranging from -0.3~0.2cm and -0.2~0.2cm for male and female students, respectively (Tables 2-2-2-5, 2-2-2-6, 2-2-2-7).

Table 2-2-2-5 Comparison of average height in students aged 6~22 (cm)

Age group	Male			Female		
	2020	2015	Difference	2020	2015	Difference
6 years	120.0	120.1	-0.1	118.7	117.6	1.1
7 years	125.5	125.0	0.5	124.6	123.9	0.7
8 years	130.6	131.1	-0.5	130.6	129.8	0.8
9 years	136.5	136.6	-0.1	136.2	135.9	0.3
10 years	142.0	142.1	-0.1	143.9	143.1	0.8
11 years	149.2	147.4	1.8*	150.9	150.9	0.0
12 years	156.7	156.3	0.4	155.2	154.1	1.1
13 years	164.2	162.8	1.4	157.8	157.1	0.7
14 years	167.5	167.9	-0.4	159.4	159.1	0.3
15 years	170.7	169.9	0.8	160.7	159.4	1.3
16 years	172.7	171.3	1.4	160.7	159.9	0.8
17 years	172.5	172.3	0.2	161.0	159.2	1.8*
18 years	172.8	171.1	1.7*	159.8	160.4	-0.6
19 years	174.1	172.5	1.6*	160.8	159.4	1.4
20 years	173.1	172.0	1.1	161.8	160.1	1.7*
21 years	172.0	171.7	0.3	160.5	160.3	0.2
22 years	171.8	172.3	-0.5	160.9	159.6	1.3

Note: Difference equals to data in 2020 minus data in 2015.

The asterisk “*” means $P < 0.05$, which applies to subsequent tables.

Table 2-2-2-6 Comparison of average sitting height in students aged 6~22 (cm)

Age group	Male			Female		
	2020	2015	Difference	2020	2015	Difference
6 years	65.9	66.1	-0.2	65.2	64.3	0.9*
7 years	68.3	68.0	0.3	67.9	67.2	0.7
8 years	70.3	70.6	-0.3	70.2	69.6	0.6
9 years	73.0	72.6	0.4	72.6	72.0	0.6
10 years	75.0	74.7	0.3	76.5	75.6	0.9*
11 years	78.3	77.0	1.3*	80.0	79.9	0.1
12 years	81.9	81.2	0.7	82.3	81.6	0.7
13 years	86.1	85.3	0.8	84.5	83.9	0.6
14 years	88.2	88.0	0.2	85.3	84.9	0.4
15 years	90.7	89.6	1.1*	86.2	85.5	0.7
16 years	91.7	91.1	0.6	86.5	86.3	0.2
17 years	92.1	91.4	0.7	87.0	86.1	0.9*
18 years	92.2	91.1	1.1*	86.4	86.4	0.0
19 years	93.1	91.6	1.5*	86.8	85.8	1.0*
20 years	92.6	91.9	0.7	87.1	86.6	0.5
21 years	92.2	91.1	1.1*	86.7	86.5	0.2
22 years	92.2	91.1	1.1*	86.6	86.3	0.3

Table 2-2-2-7 Comparison of average foot length in students aged 6~22 (cm)

Age group	Male			Female		
	2020	2015	Difference	2020	2015	Difference
6 years	18.4	18.5	-0.1	18.1	18.1	0.0
7 years	19.4	19.3	0.1	19.1	19.1	0.0
8 years	20.2	20.3	-0.1	20.0	20.0	0.0
9 years	21.0	21.1	-0.1	20.7	20.8	-0.1
10 years	21.9	22.1	-0.2	21.7	21.7	0.0
11 years	23.0	22.8	0.2	22.4	22.6	-0.2
12 years	24.0	24.0	0.0	22.7	22.8	-0.1
13 years	24.9	24.6	0.3	22.9	22.8	0.1
14 years	25.1	25.2	-0.1	23.0	23.1	-0.1
15 years	25.1	25.2	-0.1	23.1	23.0	0.1
16 years	25.2	25.2	0.0	23.1	23.1	0.0
17 years	25.1	25.4	-0.3*	22.8	22.9	-0.1
18 years	25.2	25.2	0.0	22.9	23.1	-0.2
19 years	25.5	25.3	0.2	22.9	22.8	0.1
20 years	25.2	25.3	-0.1	23.0	23.0	0.0
21 years	25.2	25.5	-0.3*	22.9	23.1	-0.2
22 years	25.3	25.5	-0.2	23.1	22.9	0.2

2.1.2 Weight and BMI

Compared with the results in 2015, the average weight of male students aged 6~22 increased by 1.6kg in 2020, with statistically significant difference observed ($P < 0.05$); that of female students aged 6~22 remained constant. The difference recorded in each age group was ranged from -0.5~4.2kg and -1.7~2.2kg for male and female students, respectively (Table 2-2-2-8).

The average BMI fluctuated in each age group. Specifically, the average BMI of male students was higher in 2020 than in 2015 in the aged 14, 17 and 20~22 groups, with statistically significant difference observed ($P < 0.05$); whereas that of female students was lower in 2020 than in 2015 in the aged 13 and 15~17 groups, with statistically significant difference observed ($P < 0.05$). No significant difference was found in other age groups in the two studies (Table 2-2-2-9).

Table 2-2-2-8 Comparison of average weight in students aged 6~22 (kg)

Age group	Male			Female		
	2020	2015	Difference	2020	2015	Difference
6 years	23.0	23.0	0.0	21.7	21.1	0.6*
7 years	25.8	25.4	0.4*	24.6	24.7	-0.1
8 years	29.0	29.5	-0.5*	28.5	28.2	0.3
9 years	34.1	33.5	0.6*	31.1	31.9	-0.8*
10 years	38.5	38.2	0.3	36.9	36.7	0.2
11 years	44.7	42.3	2.4*	42.6	43.4	-0.8*
12 years	49.5	48.4	1.1*	46.7	45.8	0.9*
13 years	55.2	54.4	0.8*	49.3	50.5	-1.2*
14 years	58.8	57.3	1.5*	51.5	52.5	-1.0*
15 years	61.4	61.1	0.3	52.2	53.7	-1.5*
16 years	64.2	64.0	0.2	53.1	54.4	-1.3*
17 years	65.7	63.2	2.5*	53.0	53.4	-0.4
18 years	64.8	62.3	2.5*	52.6	54.3	-1.7*
19 years	68.5	65.2	3.3*	54.5	53.3	1.2*
20 years	68.7	64.9	3.8*	55.4	53.3	2.1*
21 years	71.1	66.9	4.2*	54.9	53.5	1.4*
22 years	67.7	64.3	3.4*	54.6	52.4	2.2*

Table 2-2-2-9 Comparison of average BMI in students aged 6~22

Age group	Male			Female		
	2020	2015	Difference	2020	2015	Difference
6 years	15.8	15.8	0.0	15.3	15.2	0.1
7 years	16.3	16.1	0.2	15.8	16.0	-0.2
8 years	16.9	17.0	-0.1	16.5	16.7	-0.2
9 years	18.2	17.8	0.4	16.6	17.1	-0.5
10 years	19.0	18.7	0.3	17.6	17.8	-0.2
11 years	19.8	19.2	0.6	18.6	18.9	-0.3
12 years	20.0	19.7	0.3	19.3	19.2	0.1
13 years	20.4	20.4	0.0	19.7	20.4	-0.7*
14 years	20.9	20.2	0.7*	20.2	20.7	-0.5
15 years	21.0	21.1	-0.1	20.2	21.1	-0.9*
16 years	21.5	21.8	-0.3	20.6	21.3	-0.7*
17 years	22.0	21.2	0.8*	20.4	21.1	-0.7*
18 years	21.6	21.2	0.4	20.6	21.1	-0.5
19 years	22.5	21.9	0.6	21.0	21.0	0.0
20 years	22.8	21.9	0.9*	21.2	20.8	0.4
21 years	24.1	22.7	1.4*	21.3	20.8	0.5
22 years	23.0	21.6	1.4*	20.9	20.5	0.4

According to the critical values for BMI classification of underweight, normal weight, overweight and obesity in the Health Industry Standards of People's Republic of China WS/T 586-2018 and WS/T 456-2014, comparative analysis of the two studies showed that between ages 6~12, the prevalence of overweight and obesity of male children in 2020 increased by 2.3% and 1.0% respectively, with a total an increase of 3.3%; whereas the prevalence of overweight and obesity of female children in 2020 decreased by 1.3% and 2.0% respectively, with a total decrease of 3.3%. Between ages 13~18, the prevalence of overweight and obesity of male adolescents in 2020 increased by 3.6% and 1.2% respectively, with a total increase of 4.8%; whereas the prevalence of overweight and obesity of female adolescents in 2020 decreased by 1.8% and 1.0% respectively, with a total decrease of 2.8%. Between ages 19~22, the prevalence of overweight and obesity of male adolescents in 2020 increased by 5.5% and 4.2% respectively, with a total increase of 9.7%; and the prevalence of overweight of female adolescents in 2020 decreased by 0.2% and that of obesity increased by 2.8%, with a total increase of 2.6%.

For all age groups of 6~22, the prevalence of overweight and obesity in male children and adolescents increased by 3.1% and 1.7%, respectively, with a total increase of 4.8%; the prevalence of overweight and obesity in female children and adolescents decreased by 1.4% and 0.6%, respectively, with a total decrease of 2.0% (Table 2-2-2-10).

Table 2-2-2-10 Comparison of prevalence of underweight, normal weight, overweight and obesity in children and adolescents aged 6~22

Year	Age group (years)	Male				Female			
		Normal weight	Normal weight	Over-weight	Obesity	Normal weight	Normal weight	Over-weight	Obesity
2020	6~12	12.0%	56.0%	15.7%	16.3%	9.6%	71.1%	9.8%	9.6%
	13~18	15.2%	56.4%	17.6%	10.8%	9.6%	75.6%	10.0%	4.8%
	19~22	10.8%	53.9%	24.4%	10.8%	18.8%	66.0%	9.7%	5.5%
	6~22 (Total)	13.1%	55.9%	17.4%	13.6%	10.7%	72.3%	9.8%	7.2%
2015	6~12	11.4%	60.0%	13.4%	15.3%	7.0%	70.3%	11.1%	11.6%
	13~18	14.0%	62.3%	14.0%	9.6%	6.0%	76.3%	11.8%	5.8%
	19~22	12.8%	61.7%	18.9%	6.6%	19.3%	68.1%	9.9%	2.7%
	6~22 (Total)	12.6%	61.1%	14.3%	11.9%	8.8%	72.2%	11.2%	7.8%
2020 2015	6~12	0.6%	-4.0%	2.3%	1.0%	2.6%	0.8%	-1.3%	-2.0%
	13~18	1.2%	-5.9%	3.6%	1.2%	3.6%	-0.7%	-1.8%	-1.0%
	19~22	-2.0%	-7.8%	5.5%	4.2%	-0.5%	-2.1%	-0.2%	2.8%
	6~22 (Total)	0.50%	-5.2%	3.1%	1.7%	1.9%	0.1%	-1.4%	-0.6%

2.1.3 Circumference Indicators

Through comparison of the 2020 and 2015 results, the average chest and hip circumferences of male and female students were obviously higher in 2020 in most of the age groups, with statistically significant difference observed ($P < 0.05$); and the average waist circumference fluctuated among age groups. The difference recorded in the average chest circumference was ranged from -0.1~3.8cm and 1.0~3.0cm for male and female students, respectively; for the average waist circumference, the difference was ranged from -2.1~2.6cm and -2.0~1.7cm for males and females respectively; for the average hip circumference, the difference was ranged from 0.6~3.1cm and 0.8~2.8cm for males and females respectively (Tables 2-2-2-11, 2-2-2-12, 2-2-2-13).

Table 2-2-2-11 Comparison of average chest circumference in students aged 6~22 (cm)

Age group	Male			Female		
	2020	2015	Difference	2020	2015	Difference
6 years	58.4	57.8	0.6	57.2	55.3	1.9*
7 years	60.8	59.5	1.3*	59.8	58.5	1.3*
8 years	63.2	63.0	0.2	62.8	61.1	1.7*
9 years	67.5	66.4	1.1	65.3	64.3	1.0
10 years	69.7	69.8	-0.1	69.7	68.0	1.7*
11 years	74.1	72.5	1.6*	74.9	73.0	1.9*
12 years	77.2	76.0	1.2	77.3	75.1	2.2*
13 years	80.7	79.3	1.4*	79.3	78.2	1.1
14 years	83.3	80.8	2.5*	81.0	79.2	1.8*
15 years	84.9	83.8	1.1	81.3	80.2	1.1
16 years	86.2	85.5	0.7	82.2	80.4	1.8*
17 years	88.5	85.4	3.1*	82.0	80.1	1.9*
18 years	88.0	85.0	3.0*	82.7	80.8	1.9*
19 years	89.6	87.9	1.7*	84.3	81.3	3.0*
20 years	90.1	87.3	2.8*	84.6	81.8	2.8*
21 years	92.0	89.0	3.0*	84.4	82.6	1.8*
22 years	90.7	86.9	3.8*	83.6	81.1	2.5*

Table 2-2-2-12 Comparison of average waist circumference in students aged 6~22 (cm)

Age group	Male			Female		
	2020	2015	Difference	2020	2015	Difference
6 years	53.9	54.0	-0.1	52.4	51.2	1.2
7 years	56.2	55.8	0.4	54.5	54.6	-0.1
8 years	57.9	59.1	-1.2	57.2	56.7	0.5
9 years	62.6	62.7	-0.1	58.6	59.2	-0.6
10 years	65.0	66.5	-1.5*	60.8	61.7	-0.9
11 years	68.0	67.9	0.1	63.6	64.8	-1.2
12 years	69.5	69.9	-0.4	66.0	66.1	-0.1
13 years	71.4	71.8	-0.4	66.4	68.4	-2.0*
14 years	72.1	71.9	0.2	67.9	68.8	-0.9
15 years	72.3	74.4	-2.1*	68.5	69.2	-0.7
16 years	73.7	75.7	-2.0*	69.6	69.3	0.3
17 years	75.2	74.2	1.0	69.5	68.4	1.1
18 years	73.7	74.3	-0.6	69.1	68.9	0.2
19 years	76.6	77.3	-0.7	70.9	69.2	1.7*
20 years	77.1	76.4	0.7	71.1	69.6	1.5*
21 years	80.9	78.3	2.6*	70.8	70.5	0.3
22 years	78.1	75.8	2.3*	70.3	69.1	1.2

Table 2-2-2-13 Comparison of average hip circumference in students aged 6~22 (cm)

Age group	Male			Female		
	2020	2015	Difference	2020	2015	Difference
6 years	63.2	61.2	2.0*	63.3	60.8	2.5*
7 years	66.3	63.4	2.9*	66.6	65.1	1.5
8 years	68.3	67.2	1.1	69.8	67.7	2.1*
9 years	73.4	71.0	2.4*	72.8	70.9	1.9*
10 years	75.8	74.9	0.9	77.3	74.9	2.4*
11 years	80.1	77.0	3.1*	83.0	80.5	2.5*
12 years	83.1	80.9	2.2*	85.8	83.6	2.2*
13 years	86.7	84.3	2.4*	88.0	86.9	1.1
14 years	88.8	86.0	2.8*	90.2	88.6	1.6*
15 years	90.0	88.4	1.6*	90.4	89.6	0.8
16 years	90.7	90.1	0.6	91.7	90.8	0.9
17 years	92.1	89.2	2.9*	92.0	89.9	2.1*
18 years	91.0	88.4	2.6*	92.2	91.4	0.8
19 years	93.0	90.5	2.5*	93.4	91.2	2.2*
20 years	93.7	90.8	2.9*	93.8	91.0	2.8*
21 years	95.0	92.2	2.8*	93.9	91.3	2.6*
22 years	91.9	91.2	0.7	93.3	91.1	2.2*

Compared with the results in 2015, the average WHR of male and female students decreased obviously in 2020 in most of the age groups, with statistically significant difference ($P < 0.05$) ranging from -0.035~0.018 and -0.040~-0.001, respectively (Table 2-2-2-14).

Table 2-2-2-14 Comparison of average WHR in students aged 6~22

Age group	Male			Female		
	2020	2015	Difference	2020	2015	Difference
6 years	0.853	0.882	-0.029*	0.828	0.843	-0.015*
7 years	0.846	0.878	-0.032*	0.818	0.838	-0.020*
8 years	0.846	0.876	-0.030*	0.818	0.835	-0.017*
9 years	0.851	0.880	-0.029*	0.803	0.834	-0.031*
10 years	0.853	0.884	-0.031*	0.786	0.822	-0.036*
11 years	0.844	0.879	-0.035*	0.764	0.804	-0.040*
12 years	0.832	0.862	-0.030*	0.767	0.791	-0.024*
13 years	0.820	0.848	-0.028*	0.754	0.785	-0.031*
14 years	0.808	0.834	-0.026*	0.751	0.775	-0.024*
15 years	0.800	0.837	-0.037*	0.756	0.771	-0.015*
16 years	0.809	0.837	-0.028*	0.758	0.763	-0.005
17 years	0.813	0.830	-0.017*	0.755	0.759	-0.004
18 years	0.807	0.840	-0.033*	0.749	0.753	-0.004
19 years	0.820	0.853	-0.033*	0.757	0.758	-0.001
20 years	0.821	0.841	-0.020*	0.756	0.764	-0.008
21 years	0.850	0.848	0.002	0.753	0.772	-0.019*
22 years	0.848	0.830	0.018*	0.753	0.757	-0.004

2.1.4 Width Indicators

Compared with the results in 2015, the average shoulder and pelvis width of male and female students increased in 2020 in most of the age groups. However, statistically significant difference was not observed in males, but the difference was significant in most of the age groups of females ($P < 0.05$). The difference in the average shoulder width was ranged from -0.1~1.2cm in males and 0.6~1.6cm in females; and the difference in the average pelvis width was ranged from -0.5~1.1cm and 0.3~1.7cm for males and females, respectively (Tables 2-2-2-15, 2-2-2-16).

Table 2-2-2-15 Comparison of average shoulder width in students aged 6~22 (cm)

Age group	Male			Female		
	2020	2015	Difference	2020	2015	Difference
6 years	26.2	26.3	-0.1	25.8	24.7	1.1*
7 years	27.3	27.2	0.1	27.2	26.3	0.9*
8 years	28.5	28.5	0.0	28.5	27.3	1.2*
9 years	29.8	29.7	0.1	29.6	28.7	0.9*
10 years	30.8	30.7	0.1	31.0	29.4	1.6*
11 years	32.4	31.9	0.5*	32.5	31.4	1.1*
12 years	34.3	33.7	0.6*	33.5	32.6	0.9*
13 years	35.9	35.7	0.2	34.4	33.8	0.6
14 years	37.1	36.8	0.3	34.8	34.2	0.6
15 years	38.4	38.0	0.4	35.0	34.4	0.6
16 years	38.9	38.5	0.4	35.2	34.6	0.6
17 years	39.3	38.7	0.6*	35.4	33.9	1.5*
18 years	39.2	38.6	0.6*	35.4	34.0	1.4*
19 years	39.3	39.2	0.1	35.7	34.1	1.6*
20 years	39.5	39.3	0.2	35.7	34.3	1.4*
21 years	39.0	38.9	0.1	35.3	34.5	0.8*
22 years	39.6	38.4	1.2*	35.3	34.3	1.0*

Table 2-2-2-16 Comparison of average pelvis width in students aged 6~22 (cm)

Age group	Male			Female		
	2020	2015	Difference	2020	2015	Difference
6 years	19.2	19.0	0.2	19.0	18.1	0.9*
7 years	19.9	19.9	0.0	19.8	19.2	0.6*
8 years	20.4	20.9	-0.5*	20.8	20.2	0.6*
9 years	21.7	21.6	0.1	22.0	21.2	0.8*
10 years	22.2	22.4	-0.2	23.2	22.3	0.9*
11 years	23.5	23.0	0.5*	24.3	24.0	0.3
12 years	24.6	24.5	0.1	25.2	24.5	0.7*
13 years	25.7	25.3	0.4	25.8	25.3	0.5
14 years	26.3	26.2	0.1	26.5	26.2	0.3
15 years	27.1	27.1	0.0	26.9	26.4	0.5
16 years	27.5	27.4	0.1	26.7	26.3	0.4
17 years	27.7	27.2	0.5*	26.9	26.2	0.7*
18 years	27.4	27.1	0.3	27.1	26.4	0.7*
19 years	27.6	27.5	0.1	27.2	26.1	1.1*
20 years	27.4	27.2	0.2	27.6	25.9	1.7*
21 years	27.9	26.8	1.1*	27.3	26.7	0.6*
22 years	27.3	27.3	0.0	27.8	26.7	1.1*

2.2 Comparison of Physiological Function

2.2.1 Resting Pulse

Resting pulse is a basic indicator to reflect the functions of the circulatory system. Through comparison, the resting pulse of students was higher in 2020 than in 2015 in most of the age groups, in which significant difference was found in the aged 7, 12~14, 16~17, 21 groups of males and the aged 6, 9, 15, 21 groups of females ($P < 0.05$). The difference recorded was ranged from -2.4~4.8bpm and -3.6~2.6bpm for males and females, respectively (Table 2-2-2-17).

Table 2-2-2-17 Comparison of average resting pulse in students aged 6~22 (bpm)

Age group	Male			Female		
	2020	2015	Difference	2020	2015	Difference
6 years	88.9	90.1	-1.2	89.3	92.3	-3.0*
7 years	88.4	85.8	2.6*	87.9	89.2	-1.3
8 years	85.9	85.1	0.8	87.9	87.0	0.9
9 years	84.0	84.1	-0.1	84.0	87.6	-3.6*
10 years	86.9	86.3	0.6	87.0	88.8	-1.8
11 years	85.7	83.9	1.8	90.1	88.4	1.7
12 years	88.0	84.3	3.7*	87.9	85.9	2.0
13 years	85.2	80.7	4.5*	88.2	86.9	1.3
14 years	85.2	80.4	4.8*	85.0	84.2	0.8
15 years	81.6	81.1	0.5	86.1	83.5	2.6*
16 years	82.7	79.6	3.1*	86.7	85.8	0.9
17 years	81.2	78.5	2.7*	82.9	82.6	0.3
18 years	79.9	79.8	0.1	83.3	85.1	-1.8
19 years	78.9	78.0	0.9	82.6	82.1	0.5
20 years	77.8	76.9	0.9	82.5	83.4	-0.9
21 years	75.3	77.7	-2.4*	82.9	80.3	2.6*
22 years	81.5	79.6	1.9	77.9	78.4	-0.5

2.2.2 Blood Pressure

When the ventricle contracts, the blood pressure of artery rises and the highest value is called the systolic blood pressure (SBP), which reflects mainly the volume of blood being pumped out by each pulse. When the ventricle relaxes, the blood pressure of artery descends and the lowest value is called the diastolic blood pressure (DBP), which mainly reflects the peripheral resistance. The difference between SBP and DBP is called pressure difference, which reflects the elasticity of the artery wall.

Compared with the results in 2015, the SBP and DBP of male and female students aged 6~18 were higher in 2020 than in 2015 in most of the age groups, with statistically significant difference observed ($P < 0.05$); besides, the SBP and DBP of male and female students aged 19~22 were lower in 2020 than in 2015, with statistically significant difference found in males ($P < 0.05$). The difference in the SBP was ranged from -9.6~4.9mmHg and -3.6~5.7mmHg for males and females, respectively; and the difference in the DBP was ranged from -4.0~3.6mmHg and -1.8~3.3mmHg for males and females, respectively (Tables 2-2-2-18, 2-2-2-19).

Table 2-2-2-18 Comparison of average SBP in students aged 6~22 (mmHg)

Age group	Male			Female		
	2020	2015	Difference	2020	2015	Difference
6 years	100.9	97.0	3.9*	100.1	94.4	5.7*
7 years	103.9	100.8	3.1*	102.3	98.8	3.5*
8 years	105.0	102.7	2.3*	105.5	101.0	4.5*
9 years	106.8	101.9	4.9*	104.6	100.9	3.7*
10 years	105.0	103.0	2.0*	104.6	100.6	4.0*
11 years	108.1	105.4	2.7*	107.6	105.6	2.0
12 years	112.2	107.4	4.8*	107.0	104.5	2.5*
13 years	116.9	114.0	2.9*	109.6	110.1	-0.5
14 years	119.5	117.8	1.7	110.4	111.3	-0.9
15 years	122.0	120.8	1.2	111.9	109.4	2.5*
16 years	124.2	125.3	-1.1	111.2	110.8	0.4
17 years	125.4	125.2	0.2	110.6	109.9	0.7
18 years	124.1	125.6	-1.5	108.1	111.7	-3.6*
19 years	122.6	126.5	-3.9*	108.2	109.4	-1.2
20 years	123.2	126.5	-3.3*	109.8	109.3	0.5
21 years	122.5	132.1	-9.6*	111.2	110.1	1.1
22 years	125.2	127.3	-2.1*	109.3	110.1	-0.8

Table 2-2-2-19 Comparison of average DBP in students aged 6~22 (mmHg)

Age group	Male			Female		
	2020	2015	Difference	2020	2015	Difference
6 years	62.1	59.9	2.2*	63.2	59.9	3.3*
7 years	62.7	61.6	1.1	64.6	62.1	2.5*
8 years	62.5	63.3	-0.8	65.8	63.9	1.9*
9 years	66.7	63.6	3.1*	65.6	64.7	0.9
10 years	65.4	64.3	1.1	65.9	64.3	1.6
11 years	67.3	64.2	3.1*	68.6	67.1	1.5
12 years	67.4	63.8	3.6*	67.4	66.8	0.6
13 years	69.2	65.7	3.5*	69.7	67.4	2.3*
14 years	70.9	68.3	2.6*	69.8	69.0	0.8
15 years	71.4	70.6	0.8	70.1	68.4	1.7
16 years	73.2	71.9	1.3	70.9	70.1	0.8
17 years	73.2	71.2	2.0*	70.5	69.3	1.2
18 years	70.5	72.9	-2.4*	69.1	70.6	-1.5
19 years	70.6	72.6	-2.0*	68.6	69.1	-0.5
20 years	70.2	74.2	-4.0*	68.3	69.7	-1.4
21 years	71.1	74.0	-2.9*	67.8	68.5	-0.7
22 years	71.5	73.9	-2.4*	67.9	69.7	-1.8

Compared with the results in 2015, the average pressure difference of male and female students was higher in 2020 than 2015 in most of the age groups, with the difference between two studies ranging from -6.4~3.0mmHg in males and -2.7~2.8mmHg in females. Statistically significant difference was seen in the aged 7~8, 16, 21 groups of males and the aged 6, 8~10, 12~13, 18 groups of females ($P < 0.05$) (Table 2-2-2-20).

Table 2-2-2-20 Comparison of average pressure difference in students aged 6~22 (mmHg)

Age group	Male			Female		
	2020	2015	Difference	2020	2015	Difference
6 years	38.7	37.2	1.5	36.9	34.9	2.0*
7 years	41.2	39.3	1.9*	37.7	36.8	0.9
8 years	42.4	39.4	3.0*	39.7	37.1	2.6*
9 years	40.1	38.3	1.8	38.9	36.1	2.8*
10 years	39.6	38.9	0.7	38.8	36.3	2.5*
11 years	40.8	41.2	-0.4	39.0	38.5	0.5
12 years	44.8	43.5	1.3	39.6	37.8	1.8*
13 years	47.7	48.3	-0.6	40.0	42.7	-2.7*
14 years	48.6	49.5	-0.9	40.5	42.3	-1.8
15 years	50.6	50.2	0.4	41.8	41.0	0.8
16 years	51.0	53.4	-2.4*	40.3	40.8	-0.5
17 years	52.2	54.0	-1.8	40.0	40.6	-0.6
18 years	53.6	52.8	0.8	39.1	41.2	-2.1*
19 years	52.0	54.2	-2.2	39.7	40.3	-0.6
20 years	53.0	52.3	0.7	41.5	39.7	1.8
21 years	51.4	57.8	-6.4*	43.6	41.6	2.0
22 years	53.7	53.4	0.3	41.4	40.3	1.1

2.2.3 Vital Capacity

Vital capacity refers to the maximum amount of air that can be exhaled after a maximum inhalation. This indicates the maximum working capacity of the respiratory system of a human body.

Compared with the results in 2015, the average vital capacity of male students was lower in 2020 than in 2015 in most of the age groups. The difference was ranged from -352.8~222.2ml, with statistically significant difference found in most of the age groups ($P < 0.05$); the average vital capacity of female students was lower in 2020 than in 2015 in most of the age groups, with no significant difference found, and the difference among age groups was ranged from -171.9~69.4ml (Table 2-2-2-21).

Compared with the results in 2015, the average vital capacity/weight of male students was lower in 2020 than in 2015 in each age group, and the difference was ranged from -7.6~0.5ml/kg, with statistically significant difference observed in most of the age groups ($P < 0.05$); besides, the average vital capacity/weight of female students was lower in 2020 than in 2015 in most of the age groups, with no significant difference observed, and the difference among age groups was ranged from -6.6~0.9ml/kg (Table 2-2-2-22).

Table 2-2-2-21 Comparison of average vital capacity in students aged 6~22 (ml)

Age group	Male			Female		
	2020	2015	Difference	2020	2015	Difference
6 years	915.7	1089.7	-174.0*	858.9	974.8	-115.9*
7 years	1112.0	1227.4	-115.4*	1081.7	1134.5	-52.8
8 years	1447.6	1528.1	-80.5*	1319.6	1351.1	-31.5
9 years	1666.9	1721.7	-54.8*	1492.6	1525.5	-32.9
10 years	1848.4	1980.7	-132.3*	1790.4	1831.8	-41.4
11 years	2135.7	2166.3	-30.6	2055.8	2204.9	-149.1*
12 years	2571.1	2719.3	-148.2*	2337.0	2331.6	5.4
13 years	3005.2	3045.6	-40.4	2418.6	2443.8	-25.2
14 years	3317.9	3329.8	-11.9	2509.0	2638.3	-129.3*
15 years	3534.4	3714.1	-179.7*	2583.4	2755.3	-171.9*
16 years	3547.6	3900.4	-352.8*	2653.6	2797.3	-143.7*
17 years	3697.7	3972.5	-274.8*	2706.1	2732.4	-26.3
18 years	3891.9	4007.0	-115.1*	2657.8	2768.9	-111.1*
19 years	3868.6	3968.2	-99.6*	2738.7	2669.3	69.4*
20 years	4069.8	3963.9	105.9*	2806.0	2766.8	39.2
21 years	3918.4	3960.6	-42.2	2799.1	2779.2	19.9
22 years	4163.1	3940.9	222.2*	2781.8	2741.1	40.7

Table 2-2-2-22 Comparison of average vital capacity/weight in students aged 6~22 (ml/kg)

Age group	Male			Female		
	2020	2015	Difference	2020	2015	Difference
6 years	40.7	48.3	-7.6*	40.4	47.0	-6.6*
7 years	44.0	49.5	-5.5*	44.9	47.1	-2.2
8 years	51.5	53.2	-1.7	47.8	49.2	-1.4
9 years	50.7	53.0	-2.3	49.3	49.1	0.2
10 years	50.0	53.8	-3.8*	50.2	51.5	-1.3
11 years	49.9	53.0	-3.1*	49.7	52.1	-2.4
12 years	53.8	57.8	-4.0*	51.4	52.0	-0.6
13 years	56.2	57.5	-1.3	50.0	49.1	0.9
14 years	58.1	59.4	-1.3	49.7	51.1	-1.4
15 years	58.8	62.5	-3.7*	50.6	52.0	-1.4
16 years	56.8	62.3	-5.5*	51.2	52.2	-1.0
17 years	57.8	64.1	-6.3*	52.1	52.3	-0.2
18 years	61.1	65.4	-4.3*	51.0	51.6	-0.6
19 years	57.8	62.0	-4.2*	51.2	51.0	0.2
20 years	60.4	62.5	-2.1	51.3	52.6	-1.3
21 years	55.9	60.1	-4.2*	51.3	52.7	-1.4
22 years	62.6	62.1	0.5	51.9	52.8	-0.9

2.3 Comparison of Physical Fitness

2.3.1 Speed

50m run was used to reflect the speed of students. Through comparison of the 50m run results, the average time for 50m run of male students increased in 2020 in most of the age groups, with statistically significant difference found in the aged 6, 8~11 groups ($P < 0.05$), indicating that the speed of male students decreased slightly. The average time for 50m run of female students increased slightly in 2020, and no statistically significant difference was found in most of the age groups. The difference between the two studies was ranged from -0.4~0.8 second and -0.6~0.6 second for male and female students, respectively (Table 2-2-2-23).

Table 2-2-2-23 Comparison of average time for 50m run in students aged 6~22 (sec)

Age group	Male			Female		
	2020	2015	Difference	2020	2015	Difference
6 years	12.8	12.2	0.6*	13.0	12.7	0.3
7 years	11.6	11.6	0.0	12.2	11.9	0.3
8 years	11.6	10.8	0.8*	11.7	11.5	0.2
9 years	11.2	10.6	0.6*	11.4	10.9	0.5*
10 years	10.9	10.3	0.6*	11.2	10.6	0.6*
11 years	10.4	9.8	0.6*	10.7	10.1	0.6*
12 years	9.7	9.4	0.3	10.0	10.0	0.0
13 years	9.0	8.8	0.2	9.8	9.8	0.0
14 years	8.5	8.5	0.0	9.9	9.9	0.0
15 years	8.4	8.1	0.3	9.6	9.7	-0.1
16 years	8.1	8.0	0.1	9.8	9.8	0.0
17 years	8.0	7.8	0.2	9.7	9.8	-0.1
18 years	7.9	7.8	0.1	9.9	9.7	0.2
19 years	8.0	8.3	-0.3	9.8	10.1	-0.3
20 years	8.0	8.4	-0.4*	9.8	10.3	-0.5*
21 years	8.1	8.4	-0.3	9.9	10.5	-0.6*
22 years	8.2	8.6	-0.4*	10.2	10.1	0.1

2.3.2 Strength

Standing long jump, vertical jump, pull-ups (inclined pull-ups), one-minute sit-ups, grip strength and back strength were used to reflect the strength of students. Standing long jump and vertical jump mainly reflect the explosive power, while pull-ups (inclined pull-ups) and one-minute sit-ups mainly reflect muscle endurance. Grip strength and back strength reflect the maximum force that the muscle can exert.

Compared with the results in 2015, the average grip and back strength of male and female students tended to decrease in 2020, with statistically significant decrease found in most of the age groups ($P < 0.05$). The difference of grip strength in males and females between the two studies was ranged from -3.2~-0.5kg and -2.0~0.4kg, respectively. Whereas the back strength of males and females between the two studies was ranged from -3.6~6.6kg and -6.4~3.5kg respectively. (Tables 2-2-2-24, 2-2-2-25).

Table 2-2-2-24 Comparison of average grip strength in students aged 6~22 (kg)

Age group	Male			Female		
	2020	2015	Difference	2020	2015	Difference
6 years	7.8	8.3	-0.5	7.2	7.5	-0.3
7 years	9.2	10.4	-1.2*	8.4	9.5	-1.1*
8 years	10.9	12.3	-1.4*	10.0	10.8	-0.8
9 years	13.3	13.8	-0.5	12.3	12.5	-0.2
10 years	15.3	16.2	-0.9	14.6	15.5	-0.9
11 years	17.8	18.4	-0.6	17.5	18.4	-0.9
12 years	20.6	23.1	-2.5*	18.2	20.2	-2.0*
13 years	25.9	27.6	-1.7*	20.1	20.8	-0.7
14 years	28.4	30.2	-1.8*	21.4	22.4	-1.0*
15 years	32.6	34.2	-1.6*	22.1	23.2	-1.1*
16 years	34.4	35.7	-1.3*	22.1	23.4	-1.3*
17 years	35.1	36.9	-1.8*	22.9	22.6	0.3
18 years	37.0	37.5	-0.5	23.6	24.5	-0.9
19 years	37.6	38.5	-0.9	23.1	22.7	0.4
20 years	37.7	40.9	-3.2*	24.3	25.3	-1.0*
21 years	39.8	41.4	-1.6*	24.2	24.9	-0.7
22 years	40.4	41.7	-1.3*	23.2	24.7	-1.5*

Table 2-2-2-25 Comparison of average back strength in students aged 6~22 (kg)

Age group	Male			Female		
	2020	2015	Difference	2020	2015	Difference
6 years	25.5	26.0	-0.5	23.2	21.3	1.9*
7 years	29.6	31.2	-1.6*	25.1	27.8	-2.7*
8 years	33.8	36.9	-3.1*	28.2	31.1	-2.9*
9 years	40.2	43.2	-3.0*	33.1	35.9	-2.8*
10 years	45.1	46.6	-1.5*	37.1	41.8	-4.7*
11 years	54.6	49.5	5.1*	45.2	45.8	-0.6
12 years	62.9	61.3	1.6*	46.4	49.1	-2.7*
13 years	75.5	74.6	0.9	51.2	53.0	-1.8*
14 years	82.5	81.9	0.6	56.2	53.9	2.3*
15 years	91.9	91.7	0.2	57.6	59.7	-2.1*
16 years	97.2	99.1	-1.9*	53.8	60.2	-6.4*
17 years	100.2	102.1	-1.9*	56.5	55.4	1.1
18 years	107.2	100.6	6.6*	58.4	58.7	-0.3
19 years	105.2	100.7	4.5*	53.8	51.3	2.5*
20 years	107.2	109.4	-2.2*	58.7	55.2	3.5*
21 years	107.1	110.7	-3.6*	61.7	60.7	1.0
22 years	107.1	107.9	-0.8	58.4	60.7	-2.3*

Comparison of pull-ups or inclined pull-ups for male students in the two studies showed that the results of male students were generally lower in 2020 than in 2015, in which an overall significant decrease was observed in inclined pull-ups for male students aged 6~12 ($P<0.05$), and the results of pull-ups also decreased in the aged 17, 19~21 groups with significant difference ($P<0.05$). However, the results of sit-ups of female students mainly increased in 2020, in which significant increase was seen in the aged 6, 7, 15, 17, 18, 20 and 21 groups ($P<0.05$). The difference ranges between the two studies were as follows: -7.0~-2.1 times for inclined pull-ups in male students aged 6~12; -0.7~0.2 time for pull-ups in male students aged 13~22; -2.7~3.1 times for sit-ups in female students (Table 2-2-2-26).

Table 2-2-2-26 Comparison of average strength endurance in students aged 6~22

Age group	Male			Female		
	2020	2015	Difference	2020	2015	Difference
6 years	10.7	13.0	-2.3*	11.8	10.5	1.3*
7 years	10.8	12.9	-2.1*	17.4	14.3	3.1*
8 years	10.8	13.9	-3.1*	19.0	19.1	-0.1
9 years	11.2	15.5	-4.3*	20.8	20.5	0.3
10 years	12.2	18.1	-5.9*	23.7	24.5	-0.8*
11 years	11.9	18.9	-7.0*	24.1	26.8	-2.7*
12 years	12.6	17.9	-5.3*	25.7	26.3	-0.6*
13 years	0.6	0.6	0.0	27.9	27.7	0.2
14 years	0.7	0.7	0.0	28.1	28.4	-0.3
15 years	1.3	1.1	0.2*	28.9	28.4	0.5*
16 years	1.3	1.3	0.0	28.0	27.6	0.4
17 years	1.6	1.8	-0.2*	29.1	27.2	1.9*
18 years	1.8	1.7	0.1	28.3	27.3	1.0*
19 years	2.5	2.7	-0.2*	24.0	24.3	-0.3
20 years	3.1	3.8	-0.7*	26.3	25.0	1.3*
21 years	2.5	2.7	-0.2*	27.4	25.8	1.6*
22 years	2.6	2.6	0.0	24.4	24.2	0.2

Note: Strength endurance testing of students: inclined pull-ups (times) for male students aged 6~12, pull-ups (times) for male students aged 13~22, and one-minute sit-ups (times/minute) for female students aged 6~22.

The results of the two studies showed that the average standing long jump distance of male students decreased in 2020, with significant decrease recorded in the aged 8~14, 17~19 groups ($P<0.05$); the results of female students varied irregularly in 2020, in which significant difference was seen in the aged 6, 9~11, 13, 16~19 and 21~22 groups ($P<0.05$). The differences between the two studies were ranged from -11.3~2.1cm in males and -8.0~8.3cm in females (Table 2-2-2-27).

Our study showed that the average vertical jump distance of male and female students both decreased in 2020, which differed significantly in the aged 6, 9~12, 20~21 groups of males ($P<0.05$), as well as the aged 7, 9~12, 14, 15 and 18 groups of females ($P<0.05$). The differences between the two studies were ranged from -3.3~0.9cm in males and -1.9~0.8cm in females (Table 2-2-2-28).

Table 2-2-2-27 Comparison of average standing long jump distance in students aged 6~22 (cm)

Age group	Male			Female		
	2020	2015	Difference	2020	2015	Difference
6 years	102.1	100.6	1.5	98.1	93.3	4.8*
7 years	111.6	109.5	2.1*	105.7	104.1	1.6
8 years	121.1	123.1	-2.0*	113.7	115.5	-1.8
9 years	125.4	134.1	-8.7*	120.9	126.3	-5.4*
10 years	133.5	138.1	-4.6*	129.0	132.0	-3.0*
11 years	140.3	151.6	-11.3*	129.8	137.8	-8.0*
12 years	152.6	156.8	-4.2*	136.7	135.6	1.1
13 years	165.6	169.6	-4.0*	137.2	140.3	-3.1*
14 years	175.9	180.1	-4.2*	137.1	137.8	-0.7
15 years	188.1	188.7	-0.6	143.2	142.4	0.8
16 years	192.5	191.7	0.8	144.9	141.5	3.4*
17 years	191.8	198.5	-6.7*	144.6	142.4	2.2*
18 years	194.7	198.1	-3.4*	140.9	144.9	-4.0*
19 years	194.5	197.7	-3.2*	143.3	135.0	8.3*
20 years	197.4	198.9	-1.5	139.6	140.1	-0.5
21 years	194.4	194.0	0.4	145.9	141.2	4.7*
22 years	196.7	197.6	-0.9	145.1	141.8	3.3*

Table 2-2-2-28 Comparison of average vertical jump distance in students aged 6~22 (cm)

Age group	Male			Female		
	2020	2015	Difference	2020	2015	Difference
6 years	18.7	19.7	-1.0*	18.4	19.2	-0.8
7 years	21.1	21.5	-0.4	20.2	21.3	-1.1*
8 years	22.9	23.1	-0.2	21.9	22.1	-0.2
9 years	23.4	25.0	-1.6*	22.4	23.4	-1.0*
10 years	24.8	25.9	-1.1*	23.3	24.5	-1.2*
11 years	26.7	28.4	-1.7*	24.6	25.8	-1.2*
12 years	29.0	30.9	-1.9*	25.3	26.4	-1.1*
13 years	33.2	33.7	-0.5	26.2	26.3	-0.1
14 years	35.7	36.5	-0.8	25.6	26.6	-1.0*
15 years	39.2	38.3	0.9	26.0	27.9	-1.9*
16 years	41.2	40.5	0.7	26.0	26.9	-0.9
17 years	40.8	41.7	-0.9	27.6	27.1	0.5
18 years	40.8	41.7	-0.9	26.5	27.5	-1.0*
19 years	40.5	41.2	-0.7	25.1	25.7	-0.6
20 years	39.9	41.2	-1.3*	25.4	25.0	0.4
21 years	37.4	40.7	-3.3*	26.1	25.3	0.8
22 years	38.2	40.4	-2.2*	25.6	25.7	-0.1

2.3.3 Endurance Run

Endurance of students aged 6~12 was reflected by 50m×8 shuttle run, while endurance of male students aged 13~22 was reflected by the by 1,000m run and endurance of female students aged 13~22 was reflected by the by 800m run.

In the 2020 study, the average time for male students to finish 50m×8 shuttle runs and 1,000m run increased in most of the age groups, with statistically significant difference observed ($P<0.05$), indicating an overall decline in their cardiorespiratory endurance. The average time for female students to finish 50m×8 shuttle runs and 800m runs varied irregularly among age groups. In particular, the results increased significantly in the aged 9~11, 13, 17 and 18 groups ($P<0.05$), revealing that their performance declined; whereas the results decreased significantly in the aged 6, 19~21 groups, reflecting their performance was improved ($P<0.05$). The range of difference between the two studies was as follows: -4.1~10.7 seconds for males aged 6~12 and -5.7~11.2 seconds for females in 50m×8 shuttle run; -3.7~27.1 seconds for males aged 13~22 in 1,000m run; and -20.9~14.5 seconds for females in 800m run (Table 2-2-2-29).

Table 2-2-2-29 Comparison of average time of endurance run in students aged 6~22 (sec)

Age group	Male			Female		
	2020	2015	Difference	2020	2015	Difference
6 years	151.6	155.1	-3.5	153.6	159.3	-5.7*
7 years	142.6	146.7	-4.1*	146.7	149.7	-3.0
8 years	140.2	138.2	2.0*	145.1	143.6	1.5
9 years	145.9	135.2	10.7*	146.2	140.3	5.9*
10 years	142.2	134.0	8.2*	142.3	133.3	9.0*
11 years	136.7	126.2	10.5*	138.9	127.7	11.2*
12 years	127.5	117.9	9.6*	130.0	130.0	0.0
13 years	348.1	325.0	23.1*	297.0	282.5	14.5*
14 years	327.0	316.9	10.1*	287.0	291.4	-4.4
15 years	322.5	305.9	16.6*	280.6	282.9	-2.3
16 years	316.4	295.7	20.7*	290.4	285.3	5.1
17 years	309.0	281.9	27.1*	289.4	282.9	6.5*
18 years	304.4	279.9	24.5*	296.9	288.3	8.6*
19 years	312.9	292.8	20.1*	285.4	303.5	-18.1*
20 years	305.7	302.5	3.2	290.9	310.3	-19.4*
21 years	316.4	305.9	10.5*	275.1	296.0	-20.9*
22 years	318.5	322.2	-3.7*	297.5	292.8	4.7

Note: Endurance run of students: 50 m×8 shuttle run for students aged 6~12; 1,000m run for male students aged 13~22; and 800m run for female students aged 13~22

2.3.4 Flexibility

Sit and reach was used to reflect flexibility. Comparative analysis of the 2020 and 2015 results on sit and reach showed that, the results of male students in 2020 varied irregularly in each age group, in which statistically significant difference was not observed in most of the age groups; the results of female students decreased in the aged 7, 10, 11 and 15 groups, but increased in other age groups, with significant difference found in most of the age groups ($P < 0.05$). The difference between the two studies was ranged from -4.0~1.9cm in males and -1.8~2.8cm in females (Table 2-2-2-30).

Table 2-2-2-30 Comparison of average sit and reach in students aged 6~22 (cm)

Age group	Male			Female		
	2020	2015	Difference	2020	2015	Difference
6 years	4.3	3.6	0.7	7.6	7.2	0.4
7 years	3.3	4.0	-0.7	7.4	8.6	-1.2*
8 years	2.9	3.7	-0.8	8.3	7.5	0.8
9 years	2.4	3.8	-1.4	7.8	7.1	0.7
10 years	0.3	1.4	-1.1*	6.4	7.0	-0.6
11 years	1.0	1.7	-0.7	6.4	8.2	-1.8*
12 years	0.9	1.3	-0.4	8.4	6.9	1.5*
13 years	1.5	2.1	-0.6	9.8	7.9	1.9*
14 years	3.9	2.0	1.9*	10.4	8.4	2.0*
15 years	3.6	2.6	1.0	9.2	9.7	-0.5
16 years	3.5	4.2	-0.7	10.2	8.0	2.2*
17 years	4.2	2.9	1.3	9.5	8.1	1.4*
18 years	4.4	3.6	0.8	10.5	7.7	2.8*
19 years	2.9	2.7	0.2	8.1	7.1	1.0
20 years	4.3	3.9	0.4	8.8	6.6	2.2*
21 years	0.6	4.6	-4.0*	8.4	7.4	1.0
22 years	3.2	3.2	0.0	5.3	5.1	0.2

2.3.5 Reaction

Comparison of the choice reaction time in the two studies showed that except for the decrease observed in the aged 6, 18~21 groups, the average choice reaction time of male students in 2020 all increased (indicating a slightly decreased reaction) with no statistically significant difference. The average choice reaction time of female students decreased in the aged 6, 18~22 groups, with significant difference seen in the aged 19 and 20 groups ($P < 0.05$), and no significant difference seen in other age groups. The difference between the two studies was ranged from -0.03~0.04 second in males and -0.05~0.03 second in females (Table 2-2-2-31).

Table 2-2-2-31 Comparison of average choice reaction time in students aged 6~22 (sec)

Age group	Male			Female		
	2020	2015	Difference	2020	2015	Difference
6 years	0.60	0.61	-0.01	0.61	0.64	-0.03
7 years	0.57	0.55	0.02	0.58	0.57	0.01
8 years	0.54	0.51	0.03	0.55	0.54	0.01
9 years	0.51	0.47	0.04	0.53	0.50	0.03
10 years	0.47	0.45	0.02	0.49	0.47	0.02
11 years	0.45	0.43	0.02	0.47	0.46	0.01
12 years	0.43	0.41	0.02	0.46	0.46	0.00
13 years	0.43	0.42	0.01	0.45	0.45	0.00
14 years	0.41	0.41	0.00	0.44	0.43	0.01
15 years	0.41	0.40	0.01	0.43	0.43	0.00
16 years	0.40	0.39	0.01	0.43	0.42	0.01
17 years	0.39	0.39	0.00	0.43	0.43	0.00
18 years	0.38	0.40	-0.02	0.41	0.43	-0.02
19 years	0.37	0.40	-0.03	0.40	0.45	-0.05*
20 years	0.37	0.39	-0.02	0.40	0.44	-0.04*
21 years	0.38	0.39	-0.01	0.41	0.43	-0.02
22 years	0.39	0.39	0.00	0.41	0.42	-0.01

2.3.6 Balance

One foot stands with eyes closed (OFSEC) was used to reflect balance. Comparison of the results in 2020 and 2015 showed that, the average OFSEC time of male students was lower in 2020 than in 2015 in most of the age groups, in which significant difference was found in the 16~18, 20 and 22 year age groups ($P < 0.05$). The average OFSEC time of female students was lower in 2020 than in 2015 in the 11 and 16~19 year age groups with significant difference observed ($P < 0.05$), but it was significantly higher in 2020 in the 7, 9, 14, 15 and 22 year age groups ($P < 0.05$). The difference between the two studies was ranged from -13.8~3.0 seconds in males and -23.6~5.9 seconds in females (Table 2-2-2-32).

Table 2-2-2-32 Comparison of average OFSEC time in students aged 6~22 (sec)

Age group	Male			Female		
	2020	2015	Difference	2020	2015	Difference
6 years	13.8	13.1	0.7	17.6	15.4	2.2
7 years	15.9	14.9	1.0	24.4	18.9	5.5*
8 years	19.7	17.5	2.2	25.0	27.2	-2.2
9 years	23.2	22.3	0.9	30.4	26.0	4.4*
10 years	25.7	22.7	3.0*	30.9	30.9	0.0
11 years	26.0	28.8	-2.8	28.5	32.6	-4.1*
12 years	32.7	34.8	-2.1	35.5	33.0	2.5
13 years	33.2	35.6	-2.4	41.6	43.3	-1.7
14 years	32.0	30.9	1.1	44.2	39.5	4.7*
15 years	33.1	33.7	-0.6	53.2	48.4	4.8*
16 years	40.7	54.5	-13.8*	47.3	70.9	-23.6*
17 years	44.4	48.4	-4.0*	50.7	57.3	-6.6*
18 years	40.6	53.0	-12.4*	42.7	50.8	-8.1*
19 years	40.3	39.4	0.9	38.8	42.6	-3.8*
20 years	41.5	46.4	-4.9*	43.3	44.1	-0.8
21 years	44.9	45.4	-0.5	47.5	45.0	2.5
22 years	40.9	45.6	-4.7*	55.4	49.5	5.9*

2.4 Comparison of Teeth Status

2.4.1 Occurrence of Decayed Primary Teeth

Dental caries of primary teeth among male and female students occurred mainly between ages 6~12. With the substitution of primary teeth by permanent teeth, the prevalence of decayed primary teeth decreased gradually.

The prevalence of decayed primary teeth in male students was higher in 2020 than in 2015 in the aged 10, 15 groups, and the prevalence was not observed in the aged 18 group (the same as in 2015). In other age groups, the prevalence of decayed primary teeth was lower in 2020 than in 2015, which differed significantly in the aged 6 and 9 groups ($P < 0.05$). The prevalence of decayed primary teeth in female students was lower in 2020 than in 2015 except for an increase recorded in the 9 and 18 year age groups. No significant difference was found in each age group and the difference was ranged from -9.6%~0.7% in males and -10.3%~5.7% in females (Table 2-2-2-33).

The prevalence of filled primary teeth in male students was lower in 2020 than in 2015 in the aged 12, 13, 16 groups, and there was no student with filled primary teeth in the aged 17 group (the same as in 2015). In other age groups, the prevalence of filled primary teeth was found to be higher in 2020 than in 2015, which differed significantly in the aged 6, 7 and 9 groups ($P < 0.05$). The prevalence of filled primary teeth in female students was lower in 2020 than in 2015 in the aged 11, 12, 14, 15 groups, and there was no student with filled primary teeth in the aged 16, 17, 18 groups (the same as in 2015). In other age groups, the prevalence of filled primary teeth was higher in 2020 than in 2015, which differed significantly in the aged 8 and 14 groups ($P < 0.05$). The difference for males peaked at age 7, ranging from -0.8~16.4%; and the difference for females peaked at age 8, ranging from -2.8~22.1% (Table 2-2-2-34).

Table 2-2-2-33 Comparison of decayed primary teeth in students (%)

Age group	Male			Female		
	2020	2015	Difference	2020	2015	Difference
6 years	61.4	70.6	-9.2*	65.2	71.4	-6.2
7 years	66.4	73.5	-7.1	68.6	69.7	-1.1
8 years	65.8	71.3	-5.5	62.4	72.7	-10.3
9 years	57.4	67.0	-9.6*	60.6	54.9	5.7
10 years	49.7	49.4	0.3	43.0	43.2	-0.2
11 years	25.6	32.7	-7.1	18.0	18.8	-0.8
12 years	8.7	13.7	-5.0	5.4	9.9	-4.5
13 years	3.5	6.1	-2.6	3.2	7.3	-4.1
14 years	1.1	3.0	-1.9	3.3	4.9	-1.6
15 years	1.2	0.5	0.7	1.3	1.9	-0.6
16 years	2.9	4.0	-1.1	0.6	2.0	-1.4
17 years	0.6	1.9	-1.3	0.0	0.6	-0.6
18 years	0.0	0.0	0.0	1.8	0.6	1.2

Table 2-2-2-34 Comparison of filled primary teeth in students (%)

Age group	Male			Female		
	2020	2015	Difference	2020	2015	Difference
6 years	33.5	23.3	10.2*	35.0	30.7	4.3
7 years	41.6	25.2	16.4*	36.0	33.0	3.0
8 years	47.5	41.0	6.5	47.1	25.0	22.1*
9 years	38.3	29.4	8.9*	31.3	24.6	6.7
10 years	26.1	23.5	2.6	27.5	19.6	7.9
11 years	11.7	11.1	0.6	5.3	6.0	-0.7
12 years	2.4	3.2	-0.8	2.7	3.5	-0.8
13 years	0.5	1.1	-0.6	1.3	0.0	1.3
14 years	0.5	0.0	0.5	0.0	2.8	-2.8*
15 years	0.6	0.5	0.1	0.0	0.6	-0.6
16 years	0.0	0.5	-0.5	0.0	0.0	0.0
17 years	0.0	0.0	0.0	0.0	0.0	0.0
18 years	1.3	0.0	1.3	0.0	0.0	0.0

Comparison of the prevalence of missing primary teeth in the two studies showed that the prevalence was generally higher in 2020 than in 2015 or similar to that in 2015, except a decrease recorded in the aged 10 of males. No significant difference between gender was found in each age group. In the 2020 study, the prevalence of missing primary teeth was not observed in male students aged 12 onwards and female students aged 9 onwards. Comparing the results of the two studies, the difference for male students was ranged from -0.8%~1.3% and that for female students was ranged from 0%~6.5%, with the largest difference recorded at age 7 (Table 2-2-2-35).

Table 2-2-2-35 Comparison of missing primary teeth in students (%)

Age group	Male			Female		
	2020	2015	Difference	2020	2015	Difference
6 years	1.2	1.1	0.1	2.3	0.0	2.3
7 years	4.6	4.2	0.4	7.6	1.1	6.5
8 years	4.3	3.7	0.6	4.5	1.5	3.0
9 years	2.7	1.4	1.3	1.9	0.0	1.9
10 years	1.0	1.8	-0.8	0.0	0.0	0.0
11 years	0.6	0.0	0.6	0.0	0.0	0.0
12 years	0.0	0.0	0.0	0.0	0.0	0.0
13 years	0.0	0.0	0.0	0.0	0.0	0.0
14 years	0.0	0.0	0.0	0.0	0.0	0.0

2.4.2 Occurrence of Decayed Permanent Teeth

The prevalence of decayed permanent teeth in male students was lower in 2020 than in 2015 in each age group, which differed significantly in the 6, 7, 8, 11 and 13 year age groups ($P < 0.05$). The prevalence of decayed permanent teeth in female students was higher in 2020 than in 2015 in the 7, 11 and 13 year age groups, but lower in other age groups, with no significant difference found in each age group. The difference was ranged from -10.2%~-3.7% in male students and -6.7%~11.1% in female students (Table 2-2-2-36).

Table 2-2-2-36 Comparison of decayed permanent teeth in students (%)

Age group	Male			Female		
	2020	2015	Difference	2020	2015	Difference
6 years	2.8	7.8	-5.0*	9.0	10.7	-1.7
7 years	8.8	16.0	-7.2*	15.7	12.4	3.3
8 years	7.4	14.4	-7.0*	16.6	19.7	-3.1
9 years	12.8	16.5	-3.7	16.3	16.9	-0.6
10 years	17.1	22.4	-5.3	28.9	32.4	-3.5
11 years	18.9	28.7	-9.8*	26.7	26.2	0.5
12 years	23.6	27.9	-4.3	38.9	42.6	-3.7
13 years	29.0	39.2	-10.2*	49.0	37.9	11.1
14 years	36.0	39.7	-3.7	41.1	47.2	-6.1
15 years	34.3	42.9	-8.6	40.1	45.6	-5.5
16 years	42.5	49.0	-6.5	44.9	49.3	-4.4
17 years	40.2	44.4	-4.2	46.4	53.1	-6.7
18 years	34.2	39.9	-5.7	43.6	44.8	-1.2

The prevalence of filled permanent teeth in male students was higher in 2020 than in 2015 except the 8, 9, 10 and 13 year age groups, in which significant increase was found in the aged 11 group ($P < 0.05$). The prevalence of filled permanent teeth in female students was higher in 2020 than 2015 in the 11, 13, 14, 15 and 18 year age groups, but lower in other age groups, in which significant difference was seen in the 13, 14, 15 and 18 year age groups ($P < 0.05$). The difference was ranged from -3.2%~7.1% in male students and -10.3%~20.5% in female students (Table 2-2-2-37).

The prevalence of missing permanent teeth in 2020 was generally higher than in 2015 except that male students aged 7~9 and female students aged 6~9, in which the prevalence remained similar. Significant difference was found in the aged 13~16, 18 groups of male students and the aged 13~18 groups of female students ($P<0.05$) and the difference was ranged from 0%~9.8% in male students and 0%~20.7% in female students (Table 2-2-2-38).

Table 2-2-2-37 Comparison of filled permanent teeth in students (%)

Age group	Male			Female		
	2020	2015	Difference	2020	2015	Difference
6 years	1.2	0.0	1.2	0.0	2.1	-2.1
7 years	3.8	3.4	0.4	3.5	3.8	-0.3
8 years	7.8	8.5	-0.7	7.0	10.6	-3.6
9 years	9.6	12.8	-3.2	13.8	18.3	-4.5
10 years	12.6	15.3	-2.7	11.3	21.6	-10.3
11 years	19.4	12.3	7.1*	21.3	18.8	2.5
12 years	21.2	21.1	0.1	25.4	31.2	-5.8
13 years	22.5	25.4	-2.9	40.6	27.4	13.2*
14 years	24.7	21.1	3.6	49.7	29.2	20.5*
15 years	32.0	31.5	0.5	48.7	34.8	13.9*
16 years	30.5	29.5	1.0	39.9	40.7	-0.8
17 years	33.3	30.8	2.5	42.2	42.6	-0.4
18 years	35.5	31.3	4.2	52.7	39.1	13.6*

Table 2-2-2-38 Comparison of missing permanent teeth in students (%)

Age group	Male			Female		
	2020	2015	Difference	2020	2015	Difference
6 years	0.4	0.0	0.4	0.0	0.0	0.0
7 years	0.0	0.0	0.0	0.0	0.0	0.0
8 years	0.0	0.0	0.0	0.0	0.0	0.0
9 years	0.0	0.0	0.0	0.0	0.0	0.0
10 years	0.5	0.0	0.5	1.4	0.0	1.4
11 years	1.7	0.0	1.7	1.3	0.0	1.3
12 years	1.4	0.0	1.4	2.2	1.4	0.8
13 years	2.0	0.0	2.0*	6.5	0.0	6.5*
14 years	3.8	0.5	3.3*	9.9	0.0	9.9*
15 years	5.9	0.5	5.4*	9.9	0.0	9.9*
16 years	10.3	0.5	9.8*	12.7	2.0	10.7*
17 years	9.8	1.4	8.4	21.9	1.2	20.7*
18 years	9.2	1.2	8.0*	9.1	1.1	8.0*

2.5 Comparison of Vision

Poor vision is defined as naked-eye vision falling below 5.0. A naked-eye vision of 4.9 is considered as mild poor vision, while a naked-eye vision within 4.6~4.8 is considered as moderate poor vision and naked-eye vision below or equal to 4.5 is severe poor vision. Each subject was considered as a unit when doing the analysis. If the vision was different in both eyes, the one with poorer vision was used.

Comparison of the proportion of poor eyesight in 2020 and 2015 showed that the incidence rate of poor eyesight vision remained high in each age group in 2020. Generally, the proportion of male students with poor eyesight vision in male students decreased by 2.1%, from 70.0% in 2015 to 67.9% in 2020, with no statistically significant difference observed. By contrast, the proportion of students with poor eyesight was lower in 2020 than in 2015 in the 6~11 year age groups, indicating an improved level of eyesight vision in these age groups. However, no statistically significant difference between the two studies was observed among age groups except the aged 6 group ($P<0.05$). The proportion of students with poor vision was generally higher in 2020 than in 2015 in the 12~17 year age groups, in which no statistically significant difference was observed among age groups except the aged 17 group ($P<0.05$). The proportion of students with poor vision fluctuated among the 18~22 year age groups in the two studies, with no statistically significant difference observed. The proportion of poor vision in female students was 73.8% in 2020 which was as same as that in 2015. Our study also indicated that the proportion of students with poor vision in the two studies varied irregularly. No statistically significant difference between the two studies was found among age groups except the aged 9 group ($P<0.05$) (Table 2-2-2-39).

Table 2-2-2-39 Comparison of the proportion of students with poor vision at aged 6~22 (%)

Age group	Male			Female		
	2020	2015	Difference	2020	2015	Difference
6 years	43.7%	56.1%	-12.4%*	48.5%	60.0%	-11.5%
7 years	45.4%	48.7%	-3.3%	49.4%	53.3%	-3.9%
8 years	52.1%	56.4%	-4.3%	55.4%	50.4%	5.0%
9 years	60.1%	63.1%	-3.0%	72.5%	60.6%	11.9%*
10 years	60.8%	65.3%	-4.5%	71.8%	70.7%	1.1%
11 years	66.1%	69.4%	-3.3%	72.7%	69.8%	2.9%
12 years	77.4%	70.5%	6.9%	73.5%	80.9%	-7.4%
13 years	74.0%	78.3%	-4.3%	73.5%	81.5%	-8.0%
14 years	77.4%	71.2%	6.2%	82.1%	82.6%	-0.5%
15 years	81.7%	81.0%	0.7%	80.9%	77.8%	3.1%
16 years	82.2%	81.5%	0.7%	88.0%	80.0%	8.0%
17 years	82.6%	75.7%	6.9%*	89.5%	82.1%	7.4%
18 years	79.1%	79.1%	0.0%	85.9%	83.3%	2.6%
19 years	80.3%	80.0%	0.3%	80.3%	82.9%	-2.6%
20 years	79.2%	82.4%	-3.2%	82.5%	84.5%	-2.0%
21 years	81.0%	82.4%	-1.4%	84.4%	81.1%	3.3%
22 years	80.5%	76.3%	4.2%	84.4%	84.4%	0.0%
Total	67.9%	70.0%	-2.1%	73.8%	73.8%	0.0%

In comparison of the proportion of students with moderate and severe poor vision in 2020 and 2015, the total proportion of male and female students with moderate poor vision was generally lower in 2020 than 2015, in which statistically significant difference was seen in most of the age groups ($P < 0.05$); the total proportion of students with severe poor eyesight fluctuated between the two studies, with no statistically significant difference seen in most of the age groups (Table 2-2-2-40).

Table 2-2-2-40 Comparison of the proportion of students with moderate and severe poor vision at aged 6~22 (%)

Age group	Moderate			Severe		
	2020	2015	Difference	2020	2015	Difference
6 years	18.3	24.7	-6.4*	7.3	9.1	-1.8*
7 years	18.5	17.6	0.9	16.3	16.4	-0.1
8 years	17.6	20.1	-2.5	26.6	23.8	2.8
9 years	22.1	20.1	2.0	32.8	30.9	1.9
10 years	17.3	16.7	0.6	41.9	45.1	-3.2
11 years	15.4	18.2	-2.8*	47.4	45.5	1.9
12 years	17.8	20.8	-3.0*	53.2	50.8	2.4
13 years	15.5	18.4	-2.9*	52.7	54.9	-2.2
14 years	12.2	15.8	-3.6*	63.8	55.6	8.2
15 years	11.2	14.9	-3.7*	65.7	58.2	7.5
16 years	14.8	12.0	2.8*	65.7	63.7	2.0
17 years	11.5	13.6	-2.1*	71.6	59.8	11.8*
18 years	15.4	13.1	2.3*	63.3	63.2	0.1
19 years	11.9	12.3	-0.4	64.3	64.0	0.3
20 years	10.8	14.4	-3.6*	66.5	64.9	1.6
21 years	12.4	13.7	-1.3	63.6	60.6	3.0
22 years	12.3	11.6	0.7	58.9	63.5	-4.6

2.6 Comparison of Color Vision

Color vision reflects the children and adolescents' ability to distinguish colors. Through comparison of the results in the two studies, the proportion of students with abnormal color vision was lower in 2020 than in 2015, and the difference was significant in most of the age groups ($P < 0.05$), which revealed that students in most age groups had better color vision in 2020 than in 2015 (Table 2-2-2-41).

Table 2-2-2-41 Comparison of the proportion of students with abnormal color vision at aged 6~22 (%)

Age group	Male			Female		
	2020	2015	Difference	2020	2015	Difference
6 years	4.2	12.2	-8.0*	5.8	7.9	-2.1*
7 years	5.5	10.1	-4.6*	3.5	5.9	-2.4*
8 years	4.3	4.3	0.0	1.3	2.3	-1.0*
9 years	2.1	4.1	-2.0*	2.5	1.4	1.1*
10 years	2.5	2.4	0.1	0.0	0.7	-0.7*
11 years	2.2	5.8	-3.6*	0.7	0.0	0.7*
12 years	6.3	5.3	1.0	0.0	3.5	-3.5*
13 years	5.5	4.4	1.1*	0.6	1.6	-1.0*
14 years	3.8	5.0	-1.2*	1.3	0.0	1.3*
15 years	4.8	3.8	1.0*	0.0	1.9	-1.9*
16 years	2.9	4.5	-1.6*	0.6	0.0	0.6*
17 years	4.3	4.2	0.1	0.5	0.0	0.5*
18 years	3.7	8.6	-4.9*	0.6	0.6	0.0
19 years	2.4	5.7	-3.3*	0.9	1.6	-0.7*
20 years	4.8	4.3	0.5	1.0	0.0	1.0*
21 years	3.4	7.1	-3.7*	1.6	0.0	1.6*
22 years	2.4	3.2	-0.8	0.0	1.0	-1.0*

(III) Summary

1. Summary of 2020 Results on Physical Fitness Study of Children and Adolescents (Students)

1.1 Living Habits and Physical Exercises

In terms of average daily sleep time on school days and rest days of primary students, Macao primary students who slept an average of 8 hours or more daily exceeded 80% in 2020. The proportion of Macao male and female primary students who spent an average daily time of 2 hours or more on watching TV or using electronic devices on rest days in 2020 accounted for 50.8% and 45.5% respectively, far higher than on school days (17.7% for males and 17.4% for females). In 2020, the proportion of Macao primary students participating in physical exercises every week was relatively high, in which the proportion of participation in extracurricular physical exercises accounted for 84.2%.

In terms of average daily sleep time on school days and rest days of secondary students, Macao secondary students who slept 8 hours or more daily exceeded 50% in 2020. Macao secondary students spent much more time on TV and electronic devices in 2020, and the proportion of male and female students spending 2 hours or more daily accounted for 71.2% and 76.6% respectively. In 2020, the proportion of secondary students participating in physical exercises every week was relatively high, in which the proportion of participation in extracurricular physical exercises was 73.9%.

In terms of average daily sleep time on school days and rest days of male and female university students, Macao university students having an average sleep time of 8 hours or more daily exceeded 40% in 2020. The

proportion of Macao university students who participated in physical exercises 3 times or more a week in 2020 accounted for 48.0% in males and 31.5% in females, and those who never participated in strength training accounted for 35.8% and 49.9% in males and females, respectively.

1.2 Anthropometric Measurements

Regarding anthropometric measurements, Macao children and adolescents had obvious growth and development, grew and developed significantly, with the main growth period between ages 6~16 for males, and ages 6~15 for females, and the growth speed peaked in the growth spurt period (ages 7~14 for males and ages 7~11 for females), The length indicators increased with advancing age, and in which the height, sitting height, foot length, weight, width and other indicators were fully developed or nearly developed during the growth spurt period. As for the age features of overweight and obesity, the prevalence of overweight increased with advancing age in males, showing an overall incremental trend, while the prevalence of females showed a first increased first and then decreased trend. The prevalence of obesity decreased and then became stable in males as age increased, i.e. it decreased between ages 6~12 and 13~18, then remained level stable between til ages 19~22; while the prevalence of obesity decreased first and then increased in females as age increased, i.e. it decreased from the stage of primary school to senior secondary school, but then tended to increase after entering senior secondary school.

1.3 Physiological Function

In terms of physiological function, the resting pulse of Macao children and adolescents decreased with advancing age, while their blood pressure and vital capacity increased with advancing age, which differed significantly between gender. The resting pulse, blood pressure and vital capacity of males were better than those of females, with gender difference gradually increasing with age.

1.4 Physical Fitness

In terms of physical fitness, the physical fitness level of Macao children and adolescents generally improved with advancing age, with the highest increase recorded in grip strength and back strength. In comparison, males had better speed, strength and reaction, while females had better flexibility and slightly better balance than males. The gender difference in speed and strength increased with age, especially in strength.

1.5 Teeth

The prevalence of decayed primary teeth in male and female students varied in similar ways as age increased and it peaked between ages 6~9 for both genders, and then decreased gradually after age 10. The prevalence of decayed permanent teeth occurred at age 6 for both gender, accounting for 2.8% and 9.0% for males and females respectively, and afterwards it increased with age, reaching 42.5% in males aged 16 and 49.0% in females aged 13.

1.6 Vision

The proportion of students with poor vision showed a rapid increase in each age group between ages 6~17 in males and ages 6~17 in females, and then it maintained at a relatively high level.

2. Comparison of 2020 and 2015 Physical Fitness Study Results of Children and Adolescents (Students)

The proportion of male and female primary students in 2020 who had an average daily sleep time of less than 8 hours was 9.3% lower than that in 2015, revealing the average sleep time of primary students had increased

over the 5 years. In 2020, the proportion of male and female primary students spending an average daily time of 2 hours or more on TV or electronic devices in a typical week accounted for 27.1% and 25.4% respectively, which was increased by 9.4% and 9.7% respectively compared with the results in 2015. In 2020, the proportion of Macao primary students who participated in extracurricular physical exercises was 84.2%, which was increased by 8.4% from 75.8% in 2015. Statistical analysis was conducted in students who participated in extracurricular physical exercises based on the definition of “frequent exercisers”, and the results showed that the proportion of “frequent exercisers” in primary students increased from 11.8% in 2015 to 25.5% in 2020, with an increase of 13.7% recorded over the 5 years.

The proportion of male and female secondary students in 2020 who slept less than 8 hours daily decreased by 24.5% and 27.2% respectively compared with the results in 2015, indicating that the sleep time of Macao secondary students had increased considerably over the 5 years. In 2020, the proportion of secondary students spending an average daily time of 2 hours or more on TV or electronic devices in a typical week accounted for 71.2% in male students and 76.6% in female students, which was increased by 27.0% and 33.8% respectively compared with the results in 2015. In 2020, 73.9% of Macao secondary students participated in extracurricular physical exercises, which was increased by 1.8% from 72.1% in 2015. The proportion of “frequent exercisers” in secondary students accounted for 18.13% in 2020, remaining basically constant to 18.06% in 2015.

The proportion of male and female university students in 2020 who slept less than 8 hours daily accounted for 54.3% and 55.0% respectively, which decreased by 17.7% and 26.2% respectively compared with the results in 2015, reflecting that the average daily sleep time of Macao university students had improved over the 5 years.

As compared with the results in 2015, the average height of students increased in most of the age groups with no statistically significant difference. The average chest and hip circumferences of male and female students increased considerably in most of the age groups with statistically significant difference ($P < 0.05$). Besides, the shoulder width and pelvic width increased in most of the age groups, but statistically significant difference was not observed in male students, while it was statistically significant different in female students in most of the age groups ($P < 0.05$).

Compared with the results in 2015, the average vital capacity of male students was generally lower in 2020 than in 2015, and statistically significant difference was found in most of the age groups ($P < 0.05$), while the average vital capacity of most female students differed slightly in 2020 from that in 2015. In the aged 6~18 groups, majority of students had higher systolic blood pressure and diastolic blood pressure in 2020 than in 2015, with statistically significant difference observed ($P < 0.05$), whereas students aged 19~22 had lower systolic blood pressure and diastolic blood pressure in 2020 than in 2015, in which statistically significant difference was found in male students ($P < 0.05$).

Compared with the results in 2015, the physical fitness indicators of most male students aged 6~22 decreased in 2020, in which statistically significant decrease was observed in the results of standing long jump, inclined pull-ups or pull-ups, endurance run, grip strength, back strength and vertical jump in most of the age groups ($P < 0.05$); however, while the difference in the records of 50m run, sit and reach, OFSEC and choice reaction time was not statistically significant in most of the age groups. Among female students aged 6~22, the study indicators such as sit and reach, sit-ups, choice reaction time, and OFSEC generally increased, with statistically significant difference observed in sit and reach and sit-ups in most of the age groups ($P < 0.05$); while indicators comprising speed, back strength, vertical jump, grip strength, cardiorespiratory

endurance, etc. decreased in most of the age groups, with statistically significant decrease found in some of the age groups ($P < 0.05$).

Compared with the dental caries status in 2015, the prevalence of decayed primary teeth in male and female students decreased in 2020, whereas the prevalence of filled and missing primary teeth increased. The prevalence of decayed permanent teeth decreased in 2020, whereas the prevalence of filled and missing permanent teeth increased slightly. The study indicated a mild improvement in dental caries of Macao students in 2020. However, prevention efforts were required to be further enhanced.

The incidence rate of poor vision was higher in 2020 than in 2015 in each age group. In 2020, it was decreased by 2.1% in male students from that in 2015, and remained unchanged in female students.

III. Adults

(I) Physical Fitness Conditions of Adults in 2020

1. Basic Information of the Subjects

Adult subjects were divided into two categories: 1) labor intensive worker engaged in light physical labor (daily work done seated with upper limb movements, or standing or walking most of the work time) and heavy physical labor (daily work requires heavy physical activities, manual load handling, lifting or digging, etc.); and 2) non-labor intensive worker mainly engaged in sedentary work. These two categories were further divided into 32 groups according to gender and age. The sample size by gender in each age group was shown in Table 2-3-1-1. There were a total of 949 subjects (418 males and 531 females) drawn from government institutions and 2,943 subjects (1,083 males and 1,860 females) from private institutions and organizations (Table 3-3-1-1).

Table 2-3-1-1 Sample size of adult subjects in each age group

Gender	Age group	Labor intensive worker	Non-labor intensive worker	Subtotal
Male	20~24 years	83	86	169
	25~29 years	107	108	215
	30~34 years	107	106	213
	35~39 years	87	106	193
	40~44 years	93	85	178
	45~49 years	83	84	167
	50~54 years	94	87	181
	55~59 years	99	86	185
Female	20~24 years	95	101	196
	25~29 years	117	308	425
	30~34 years	128	334	462
	35~39 years	103	226	329
	40~44 years	85	125	210
	45~49 years	122	144	266
	50~54 years	123	117	240
	55~59 years	166	97	263
Total		1692	2200	3892

According to the occupation of subjects, there were 89 legislative officers, administrators or managers from the public or private institutions (39 males and 50 females), 580 professionals (240 males and 340 females), 529 technicians and professional assistants (236 males and 293 females), 1,205 office clerks (325 males and 880 females), 645 customer service and sales representatives (302 males and 343 females), seven workers in agricultural and fishery fields (3 males and 4 females), 36 handicraft workers (24 males and 12 females), 58 machine operators, drivers or assemblers (53 males and 5 females), 61 non-technicians

(22 males and 39 females) and 369 subjects with other occupations (184 males and 185 females) (Table 3-3-1-2).

Among the subjects, 1,339 subjects were drawn from the north area (Nossa Senhora de Fátima); 977 subjects were from the central area (Santo António and São Lázaro); 1,556 subjects were from the south area (São Francisco Xavier, Nossa Senhora do Carmo, São Lourenço and Sé Catedral); and 20 subjects were residing in Mainland China. Additionally, 2,200 of all subjects mainly engaged in sedentary work (such as computer use, paperwork, etc.); 1,593 subjects mainly engaged in the work done by sitting with upper limb movements, or standing or walking most of the work time (such as taxi drivers, sales personnel, assembly line workers, etc.); and 99 subjects mainly engaged in heavy physical activities, manual load handling, lifting or digging, etc. (such as construction workers, etc.). In 2020, the proportion of subjects engaged in sedentary work, the work done by sitting with upper limb movements, and heavy physical activities accounted for 49.8%, 45.5% and 4.7% in males and 60.7%, 38.1% and 1.2% in females, respectively (Tables 3-3-1-3 and 3-3-1-4).

In terms of birthplace, 69.1% of males and 61.4% of females were born in Macao; 4.6% of males and 3.7% of females were born in Hong Kong; and 23.1% of males and 32.1% of females were born in Mainland China. The proportion of those born in Mainland China increased with advancing age (Table 3-3-1-5).

In terms of education level, subjects who had college or university education contributed to the biggest proportion, of over 60% for both males and females; those who had primary and secondary education exhibited a similar proportion in males (23.7%) and females (23.3%); and subjects with doctoral degrees and those who had below primary school education accounted for an extremely low proportion (Table 3-3-1-6).

Among adult subjects with regular work, the majority of them normally worked 5 days a week, with 66.0% of males and 71.6% of females; followed by 6 days a week (28.6% of males and 23.3% of females); those who worked 7 days a week and 4 days or less a week accounted for a small proportion. In terms of longitudinal study of age, the proportion of subjects who worked 5 days a week tended to increase with advancing age, whereas those who worked 6 days a week decreased with age (Table 3-3-1-7).

In regards to the daily working hours, 70.4% of males and 72.5% of females worked an average of 5 to 9 hours each day. However, 9.9% of males and 8.5% of females worked an average of 10 hours or more each day (Table 3-3-1-8).

2. Lifestyle

Information regarding lifestyle which encompassed five areas, namely, living habits, physical exercise, occurrence of diseases, perception of the physical fitness study and fitness literacy was analyzed. The results were shown as follows:

2.1 Living Habits

Living habits mainly included average daily sleep time, average daily sitting time, transportation means and leisure-time activities.

The study results showed that in 2020, male and female adults aged 20~39 who sleep less than 6 hours (exclusive) daily accounted for 3.5% and 4.3%, respectively; male and female adults aged 40~59 who sleep less than 6 hours (exclusive) daily accounted for 2.8% and 7.0%, respectively. Among adults aged 20~59, the proportion of those having an average sleep time of less than 6 hours (exclusive) daily was 3.2% in males and 5.4% in females. Therefore, it was indicated that Macao adults had sufficient sleep time. Males who have a sleeping time of less than 6 hours (exclusive) were significantly lower than females ($P < 0.05$), whereas females

who had 6~9 hours of sleep were significantly lower in proportion compared to males ($P < 0.05$). However, no significant difference between genders was found in those having an average daily sleep time of more than 9 hours (Table 3-3-2-1).

In terms of average daily accumulated sitting time of adults, the proportion of adults who sat for an average of less than 3 hours daily accounted for 6.0% in males and 5.4% in females in 2020, with no significant gender difference; the proportion of those having an average daily sitting time of 9 hours or more accounted for 25.2% in males and 30.4% in females, with the proportion of females significantly higher than that of males ($P < 0.05$); and the proportion of males and females who sat for an average of 6~9 hours daily accounted for 42.8% and 41.6% respectively, with no significant gender difference. Our study showed that Macao adults' daily sitting duration is relatively long, particularly females (Table 3-3-2-2).

In 2020, the proportion of male and female adults' means of transportation that are non-motorized (such as walking or bicycling) was remarkably lower than that of those whose means of transportation are motorized (e.g. motorcycling, driving private cars or taking public transport) ($P < 0.05$). Males who ride the motorcycled contributed to the highest proportion of 34.8%, while females commuting by vehicle (car or bus) had the highest proportion of 40.8%. Among subjects, the proportion of males and females aged 20~39 who walk or ride the bicycle accounted for 19.3% and 28.1% respectively, while that of males and females aged 40~59 accounted for 23.3% and 39.2%, respectively. As age increased, the proportion of subjects who preferred walking increased. The proportion of females who walk, ride the bicycle, and commute by public transport/private car/motorcycle was significantly higher than males; whereas the proportion of females who ride the motorcycle and drive was considerably lower than males in motorcycling and driving ($P < 0.05$) (Tables 3-3-2-3 and 3-3-2-4).

The largest proportion of subjects who walk or ride the bicycle for at least 10 minutes a day in a typical week was recorded as 0~2 days per week and 6~7 days per week for males and females, respectively. Female adults walk or ride the bicycle more frequently than males. The proportion of male adults who walk or ride the bicycle reached a peak of 35.1% in the aged 55~59 group, with the lowest proportion of 27.4% recorded in the aged 25~29 group; and the proportion of female adults who walk or ride the bicycle reached a peak of 58.6% in the aged 55~59 group, with the lowest proportion of 31.1% observed in the aged 20~24 group (Table 3-3-2-5).

The proportion of males and females who walk or ride the bicycle of less than 0.5 hour accounted for 49.8% and 41.1% respectively, in which the proportion of females aged 55~59 who spend 2 hours or more in walking or bicycling peaked at 15.2% (Table 3-3-2-6).

The most popular leisure-time activities for adults in descending order were using laptop computers/mobile phones/game consoles, watching TV, physical exercising, chatting, social gathering, doing house chores, listening to the radio and music, and playing with children, in which males had higher proportion in using computers/mobile phones/game consoles, physical exercising, listening to the radio and music, and playing with children than females ($P < 0.05$), whereas chatting, social gathering and doing house chores had higher proportion in females than males ($P < 0.05$) (Table 3-3-2-7).

2.2 Physical Exercise

In terms of frequency (times per week) of physical exercise, the proportion of male and female adults aged 20~39 who exercise 3 times or more per week accounted for 49.9% and 32.9% respectively; and those who exercise once or less per week accounted for 19.2% and 31.4%, respectively. Among adults aged 40~59, 53.6% of males and 51.9% of females exercise 3 times or more per week; and 16.5% of males and 17.4% of females exercise once or less per week. Therefore, the proportion of adults aged 20~39 who exercise every week was far lower than that of adults aged 40~59. In the aged 20~59 groups, the proportion of males taking

physical exercises 3 times or more per week was significantly higher than that of females ($P < 0.05$); whereas the proportion of females who exercise once or less per week, less than once per month and never exercised was noticeably higher than that of males ($P < 0.05$). No significant gender difference was observed in those who exercise 2 times per week (Figure 2-3-1-1, Table 3-3-2-8).

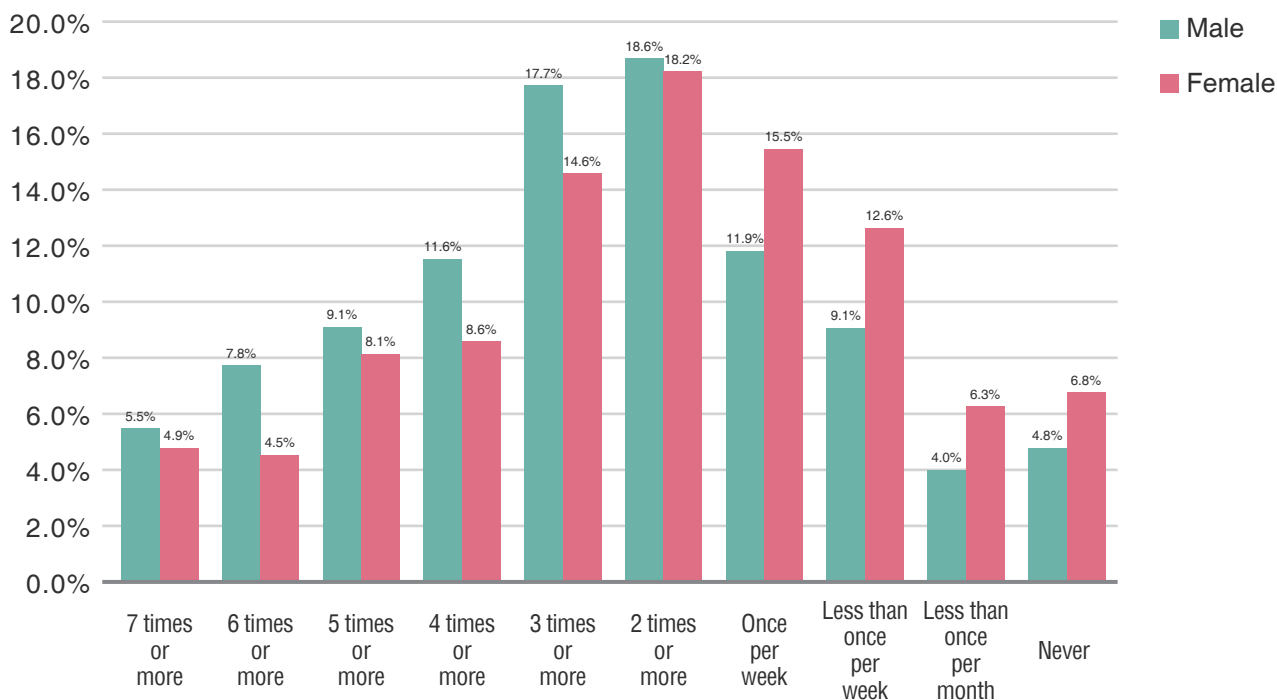

Figure 2-3-1-1 Proportion of average frequency of physical exercise per week in adults

Among those who exercise, the proportion of males and females aged 20~39 who exercise for 30 minutes or more each time accounted for 82.4% and 73.5% respectively, while the proportion of males and females aged 40~59 were 78.8% and 79.3%, respectively. Therefore, the proportion of males aged 20~39 who exercise for 30 minutes or more was 3.6% higher than that of males aged 40~59, while the proportion of females aged 20~39 who exercise for 30 minutes or more was 5.8% lower than that of females aged 40~59. Among adults aged 20~59, the proportion of male adults who spend more than 120 minutes in each exercise session peaked at 13.2% in the 20~24 year age group, and the lowest proportion was recorded in the 40~44 year age group with 3.6%. The exercise duration of male adults generally ranged from 30~119 minutes. The proportion of female adults who exercise for more than 120 minutes is extremely low, with the highest at 5.0% in the 55~59 year age group, while merely 2.0% of females aged 35~44 exercised for more than 120 minutes. Female adults generally spent 30~59 minutes in each exercise session. Exercise duration of Macao adults chiefly ranged from 30~59 minutes, followed by 60~119 minutes. In general, male adults had slightly longer average exercise duration than female adults (Figure 2-3-1-2, Table 3-3-2-9).

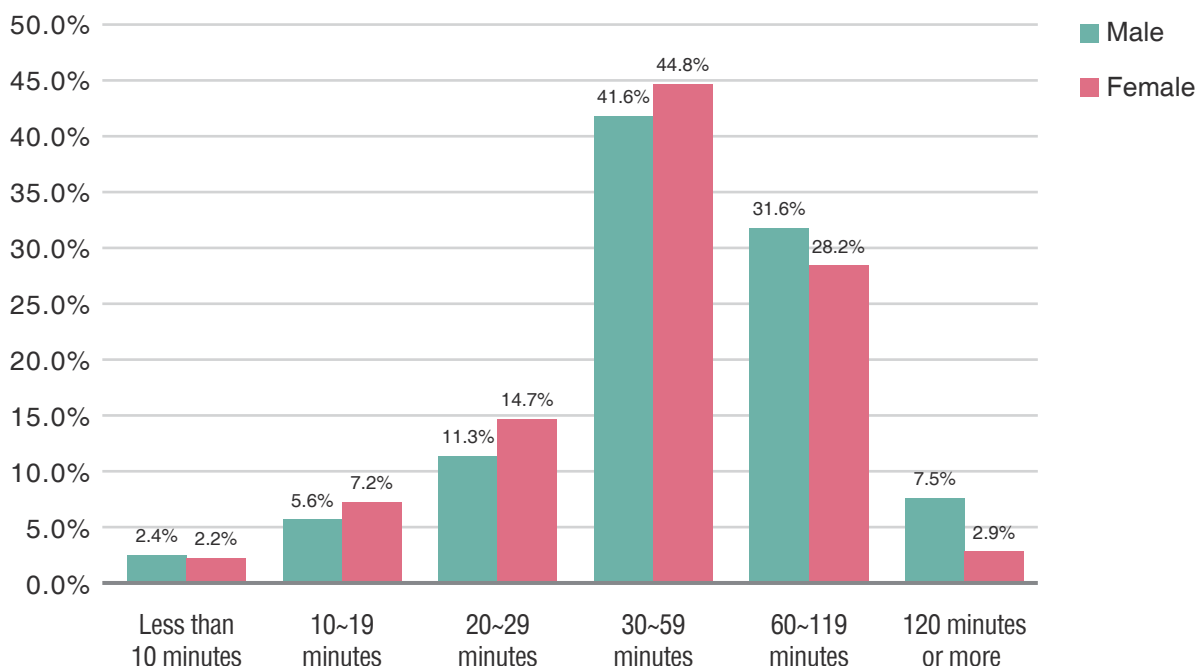

Figure 2-3-1-2 Proportion of average duration of each physical exercise in adults

In terms of exercise intensity, 59.1% of male adults had significant increased in breathing, heart rate and sweating at each exercise session, and 36.4% had slight increase in breathing, heart rate and sweating. Only 4.5% of males felt little change in breathing and heart rate during exercise. The proportion of male adults who were able to reach high exercise intensity peaked at 69.0% in the 30~34 year age group, however, only 49.7% of males aged 45~49 reached high exercise intensity. Among female adults who exercise, the proportion of those who were able to reach self-perceived high exercise intensity peaked at 47.0% in the 40~44 year age group, but only 25.7% in the 55~59 year age group. Our study showed that the proportion of self-perceived high exercise intensity of males was higher than that of females in each age group, whereas the proportion of males was significantly lower than that of females in low and moderate exercise intensity ($P < 0.05$) (Figure 2-3-1-3, Table 3-3-2-10).

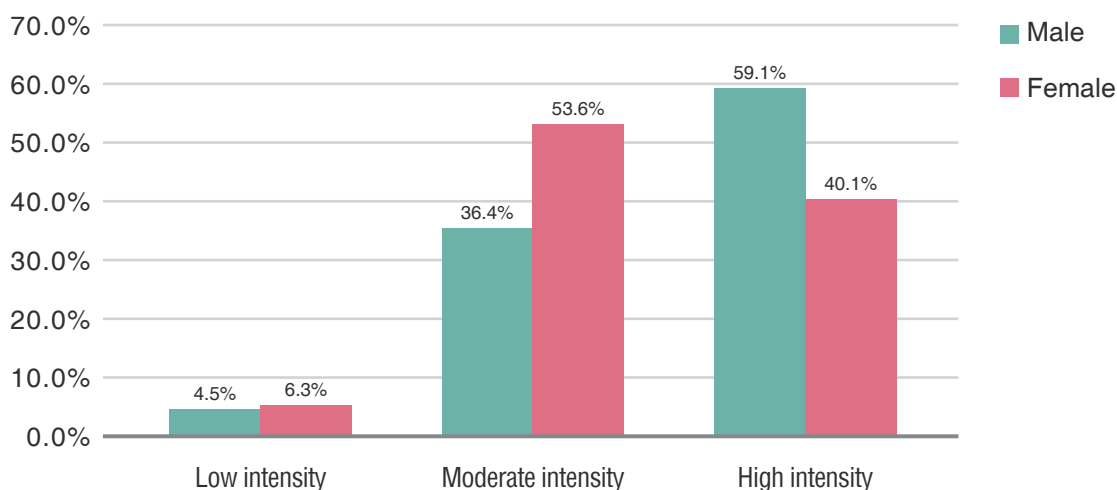

Figure 2-3-1-3 Proportion of intensity of physical exercise in adults

Subjects who concurrently met the three criteria of “exercising 3 or more times weekly”, “each exercise session for 30 minutes or more” and “each exercise session reaches moderate exercise intensity or above” were defined as “frequent exercisers”. In 2020, the proportion of frequent exercisers, occasional exercisers and non-exercisers accounted for 36.1%, 57.9% and 6.0%, respectively, among which 43.5% of males and 31.5% of females were frequent exercisers, indicating that such proportion was higher in males than females ($P < 0.05$). The proportion of male frequent exercisers reached a peak of 55.0% in the aged 20~24 group, and female frequent exercisers peaked at 42.6% in the aged 55~59 group (Tables 3-3-2-11 and 3-3-2-12).

Among subjects who participated in physical exercise as per the given exercise frequency, duration and intensity, the proportion of adults who persisted in exercising for 1 year or more reached a peak of 43.2%, followed by 1~3 months (16.3%). The proportion of males who persisted in exercising for more than 6 months was significantly higher than that of females ($P < 0.05$), and the proportion of females who persisted in exercising for less than 6 months or did not keep on exercising ($P < 0.05$) was considerably higher than males. The proportion of male and female adults who persisted in exercising for 1 year or more increased with advancing age, with the highest proportion observed in the aged 55~59 group with 62.6% for males and 69.7% for females (Table 3-3-2-13).

In addition, among subjects who exercise, the frequency of adults who do strength training (including bodyweight exercise such as push-ups, sit-ups, pull-ups, and squats; or equipment workout such as using dumbbells and elastic bands, etc.) per week was as follows: The proportion of subjects who do strength exercises ranged from 0 days to 7 days and decreased in descending order, with the highest proportion recorded in those who do 0 day per week, and the lowest proportion in 6 days or 7 days per week. The proportion of males who has no habit of strength training was 36.1% and that of females was 59.5%, which indicated that the proportion of females with no habit of strength training was significantly higher than that of males ($P < 0.01$). The proportion of adults not taking any strength training increased with advancing age, with the highest proportion recorded in the aged 55~59 group, 46.0% for males and 74.3% for females (Figure 2-3-1-4, Table 3-3-2-14).

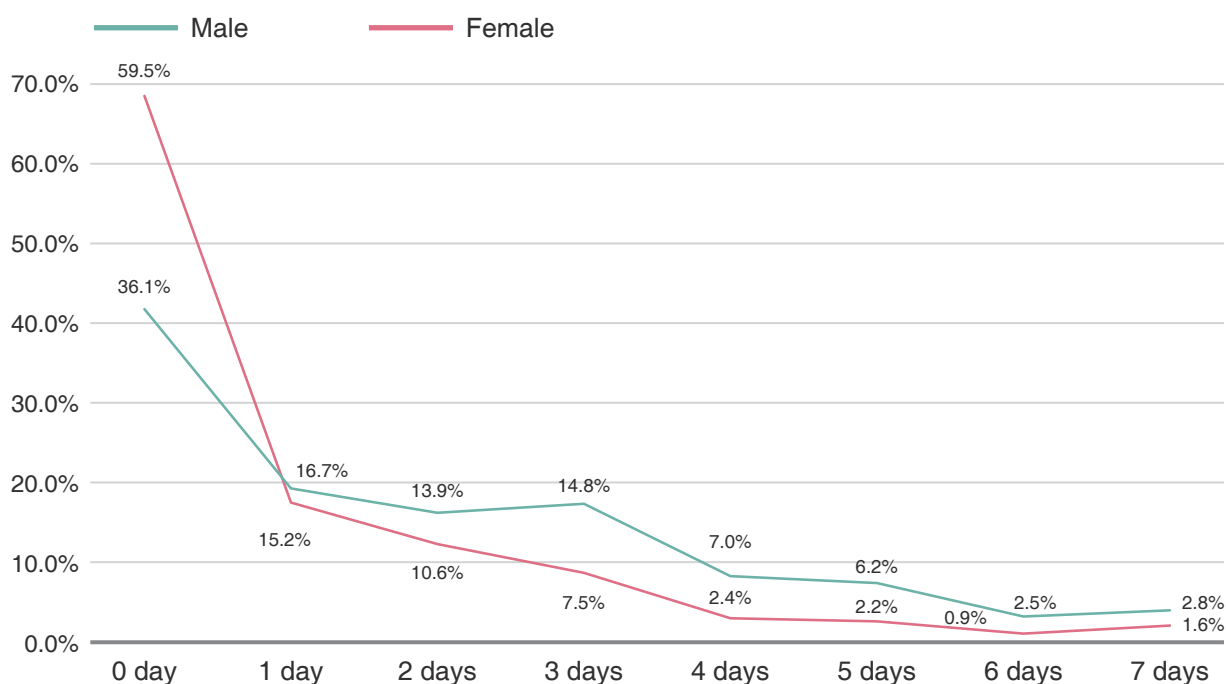

Figure 2-3-1-4 Proportion of adults who does strength training with varying frequency per week

Among adult subjects who exercise, the top six types of exercises for male adults were running, walking, swimming, playing badminton, bicycling and strength training, which accounted for 74.6%, 60.2%, 47.3%, 36.5%, 34.9% and 30.2% in males, respectively. The top six types of exercises for female adults were walking, running, yoga and Pilates, swimming, playing badminton and bicycling, accounting for 71.6%, 50.8%, 45.4%, 36.6%, 30.0% and 27.1% in females, respectively. The proportion of males who does strength training and body-building was nearly twice than that of females, while the proportion of females doing yoga and Pilates was multiple times than that of males. Males and females who did not participate in any physical exercises accounted for 3.1% and 5.4%, respectively (Table 3-3-2-15).

The major reasons for adults taking the above-mentioned physical exercises were as follows, in descending order: random choices, convenient to practice, and making choice paralleled with their families, friends or colleagues. These reasons accounted for 42.9%, 28.1% and 20.1% among males, and 39.2%, 33.1% and 17.5% among females, respectively (Table 3-3-2-16).

The major obstacles that hindered adults to participate in physical exercises were as follows: the major obstacles for males in descending order were busy work schedule, lack of venues, burden of house chores, lack of venues nearby, lack of coaching advice and concerns of injuries, which accounted for 77.1%, 35.4%, 31.5%, 27.6%, 21.1% and 15.9% respectively; the major obstacles for females in descending order included busy work schedule, lack of venues nearby, burden of house chores, lack of coaching advice, lack of venues and lack of interest, which accounted for 69.1%, 32.7%, 32.5%, 29.9%, 23.0% and 13.9% ,respectively. The proportion of males who were not available for exercise due to busy work was higher than that of females ($P < 0.05$), and the proportion of males not available for exercise for venue-related reasons was also higher than that of females (35.4% for males and 23.0% for females) (Table 3-3-2-17).

2.3 Occurrence of Diseases

The study results showed that 42.5% of adult subjects had suffered from hospital-diagnosed diseases in the past 5 years, and the prevalence of disease in females (44.7%) was higher than that in males (38.9%) ($P < 0.05$). The highest prevalence was recorded in the aged 50~54 group, accounting for 55.2% and 59.6% of males and females respectively, while the lowest prevalence was found in the aged 20~24 group, accounting for 21.9% and 29.6% of males and females, respectively (Table 3-3-2-18).

Among adult subjects with hospital-diagnosed diseases, the top five common diseases among males were enteritis, gastritis (18.5%), accidental injury (15.6%), hypertension (14.7%), pharyngitis (14.1%) and rhinitis (12.8%); the top five diseases among females were enteritis and gastritis (22.8%), pharyngitis (14.0%), anemia (12.3%), rhinitis (9.8%) and allergic dermatitis (9.0%). The prevalence of accidental injuries and hypertension among males was relatively high, while that of pharyngitis and anemia was relatively high among females. The prevalence of diseases, such as hypertension, hyperlipemia and intervertebral disc herniation, increased with advancing age, which differed significantly among age groups ($P < 0.05$), but no obvious trend was found in other diseases among age groups (Table 3-3-2-19).

2.4 Perception of the Physical Fitness Study

The study results indicated that the proportion of adults who had heard of the physical fitness study exceeded 50% in all age groups, among which males aged 50~54 peaked at 69.1%, and females aged 40~44 accounted for 68.6%. As age increased, the proportion of adults who had previously participated in the physical fitness study tended to increase, the proportion of females over aged 40 who had participated in the physical fitness study exceeded 30.0%. In terms of perception of the physical fitness study, subjects who considered the study helpful to understand their own physical fitness status exhibited the highest proportion of 97.2%, followed by those who

considered it helpful to recognize the importance of physical exercise and enhance knowledge of scientific fitness, and only 2.4% considered the study meaningless (Tables 3-3-2-20 and 3-3-2-21).

2.5 Fitness Literacy

The study was based on the questionnaire survey conducted among Macao residents aged 3~79 in 2020. All the evaluative dimensions of scientific fitness literacy were examined in the aged 19~59 groups (subdivided into the aged 19~29, 30~39, 40~49, 50~59 groups), and the study results of 4,533 samples collected were analyzed as follows:

2.5.1 Cognition

91% of adult subjects had the right perception of exercising. The proportion of adults with positive perception of exercising was 20% higher than that of children and adolescents, and younger subjects had a higher proportion than eldersubjects, i.e. 91.3% for subjects aged 19~29, 93.8% for subjects aged 30~39, 89.8% for subjects aged 40~49, and 89.1% for subjects aged 50~59. In terms of their perception of the functions of exercising, being healthy and fit is still considered to be the biggest function, followed by to relieve pressure, and to hone the will.

2.5.2 Attitude

More than 80% of adults held a positive attitude of exercising. Generally, adults had a higher proportion than children and adolescents in holding a positive attitude towards exercising, and the proportion of positive attitude became higher as age increases. The proportion of subjects aged 19~29 with a positive attitude was relatively low, 35% of them considered exercising boring and 20% thought exercising was worthless. The proportion was generally equivalent to that of adults of Mainland China (Figure 2-3-1-5).

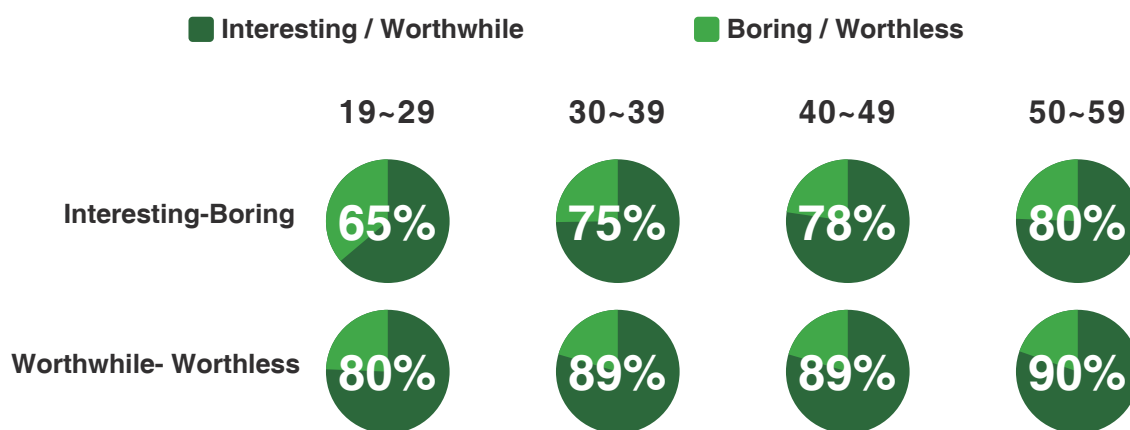

Figure 2-3-1-5 Proportion of physical fitness emotion in adults

Approximately 40% of adults had prepared with concrete plans when exercising. About 70% of adults believed that they could keep on exercising as long as they had the desire for fitness. However, research indicates that individuals often need concrete plans (such as time and location) to transition from wishful thinking to actual action. Otherwise, many ideas will only stay at the psychological level. The proportion of adults with behavior tendency was 40%, which meant that the connection from emotion to belief to behavior tendency was not connected close enough, and a certain proportion of subjects did not transfer their fitness preferences into feasible plans. In contrast, the behavior tendency of adults of Mainland China was relatively high, with up to 60% in general.

2.5.3 Ability and Skill

Adult subjects participated in a relatively narrow range of physical exercises than children and adolescents. The average number of exercises in which adults participated was 4.32 per person between aged 19~29, 4.07 per person between aged 30~39, 4.2 per person between aged 40~49 and 3.64 per person between aged 50~59, large difference when compared to that of children and adolescents. However their participation in each type of exercise was relatively high, with a high proportion of over 70% recorded in some exercises. Based on the study of exercise types, the exercises chosen by adults were also quite different from those of children and adolescents. Popular exercises among adults were generally with lower intensity of physical confrontation, less restrictions on exercising (such as the requirements for the number of participants, venue and equipment), and were mainly rhythmic exercises that help with body shaping. In terms of exercise persistence, swimming, bicycling and playing badminton had the best continuity from childhood to adulthood (excluding running and brisk walking, because these were easily confused with walking and running among daily activities, and it was difficult to determine whether they were conducted for exercise purposes). Continuous participation in these exercises can lay a solid foundation for lifelong exercise of individuals. In contrast, the number of physical exercises in which mainland adults participated was fewer, with an average of less than 3 exercises per person. Yet, they had a much higher level of participation rate despite relatively mononymous types of exercises participated (Figure 2-3-1-6).





	20~29	30~39	40~49	50~59
	Running 66.9%	Running 64.8%	Walking 72.1%	Walking 78.7%
	Walking 58.1%	Walking 63.2%	Running 59.7%	Running 45.5%
	Swimming 42.2%	Swimming 42.0%	Swimming 41.0%	Swimming 36.8%
	Badminton 40.2%	Yoga or Pilates 35.2%	Bicycling 35.0%	Yoga or Pilates 25.8%
	Yoga or Pilates, strength exercise or body building, bicycling, hiking or rock climbing, basketball, rope skipping	Bicycling, badminton, strength exercise or body building, hiking or rock climbing, rope skipping, aerobics	Badminton, yoga or Pilates, hiking or rock climbing, table tennis, aerobics, basketball	Bicycling, hiking or rock climbing, badminton, table tennis, aerobics

Figure 2-3-1-6 Proportion of types of exercise participation in adults

2.5.4 Behavior and Habit

31% of adults reached the amount of exercise recommended by the World Health Organization (WHO). According to the Guidelines on Physical Activity and Sedentary Behavior (2020 version) issued by WHO, the recommended amount of exercise for adults aged 18~64 is at least 150~300 minutes of moderate-intensity aerobic exercise or 75~150 minutes of high-intensity aerobic exercise including at least 2 days of strength training. According to the criteria, the proportion of subjects who were able to reach the above criteria accounted

for 31.3%, 24.6%, 29.0% and 39.5% in the aged 19~29, 30~39, 40~49 and 50~59 groups, respectively. Based on the standard of frequent exercisers, 35.5% of adults were frequent exercisers, and those who met the standards accounted for 35.1%, 30.0%, 36.4% and 43.2% in the aged 19~29, 30~39, 40~49 and 50~59 groups, respectively.

3. Anthropometric Measurements

3.1 Length Indicators

The average height of Macao male adults aged 20~39 declined with advancing age, afterwards increased slightly, with the average height of 171.8cm recorded in the 40~44 years age group, which remained almost constant to that of males aged 30~34; then the average height decreased with advancing age in males aged 45 onwards. The average height of female adults generally declined with advancing age. The highest average height was found in the 20~24 year age group, 173.0cm for males and 160.4cm for females; the lowest average height was observed in the 55~59 year age group, 167.6cm for males and 156.3cm for females (Figure 2-3-1-7 and Table 3-3-3-1).

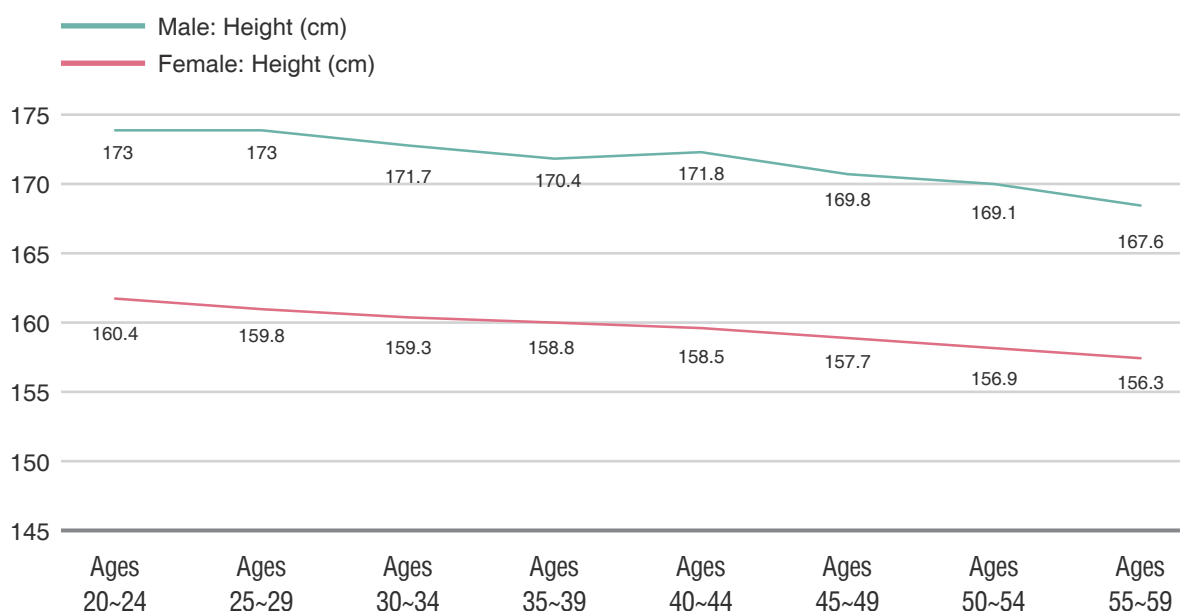

Figure 2-3-1-7 Average height of male and female adults in each age group

The average sitting height of males aged 20~39 declined with advancing age, and increased slightly between ages 40~44, afterwards tended to decline again with age after the age of 45. The average sitting height of females tended to decline with advancing age. The average sitting height of males and females ranged from 90.3~92.3cm and 85~86.7cm, respectively (Figure 2-3-1-8 and Table 3-3-3-2).

Foot length stopped increasing during adolescence, then remained stable and varied little during adulthood. The average foot length of males and females ranged from 24.6~25.4cm and 22.7~22.9cm, respectively (Figure 2-3-1-9 and Table 3-3-3-3).

Length indicators differed between genders, with height, sitting height and foot length higher in males than females ($P < 0.05$). The difference between males and females were 11.3~13.3cm for height, 5.3~6.0cm for sitting height and 1.8~2.6cm for foot length.

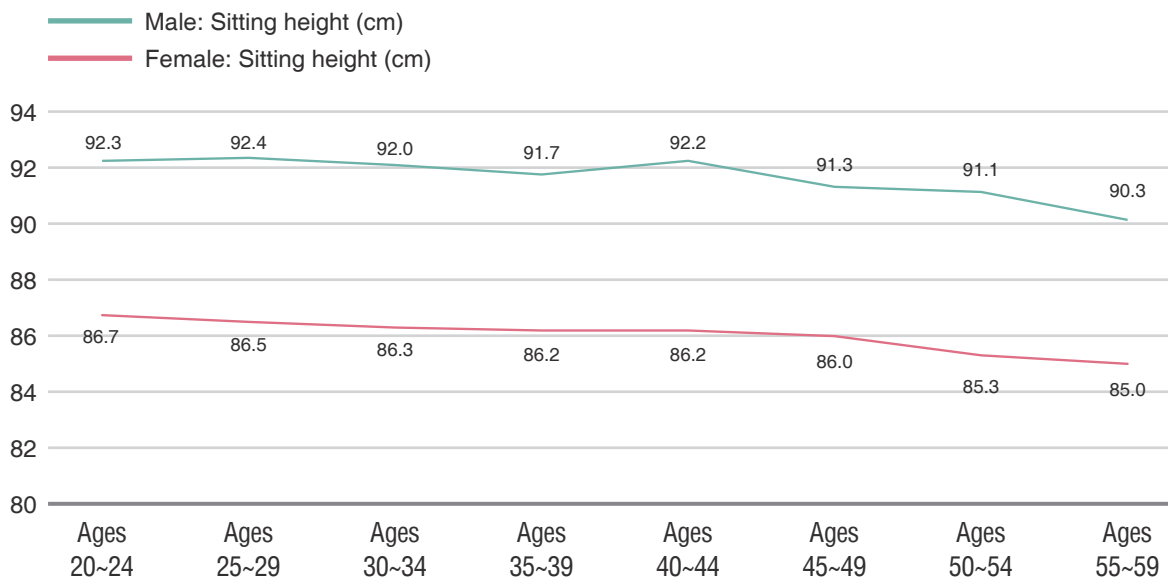

Figure 2-3-1-8 Average sitting height of adults

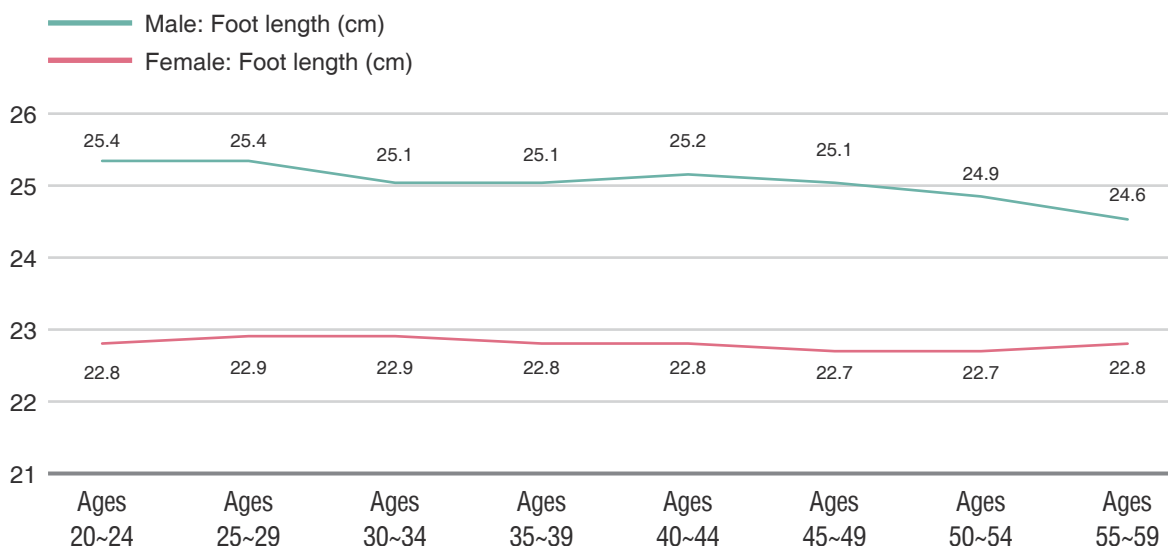

Figure 2-3-1-9 Average foot length of adults

3.2 Weight and BMI

Before age 29, weight of male adults continued to increase with advancing age, and varied mildly between ages 30~54, afterwards declined from age 55 onwards. The maximum weight of males was 70.6kg recorded in the 40~44 year age group and the minimum weight of 67.4kg was found in the 55~59 year age group. For female adults, the minimum weight was 53.3kg recorded in the 20~24 year age group and the maximum weight was 56.4kg in the 50~54 year age group. Males had a significantly higher weight than females ($P < 0.05$) and the gender difference decreased with advancing age, ranging from 11.4~15.6kg (Figure 2-3-1-10, Table 3-3-3-4).

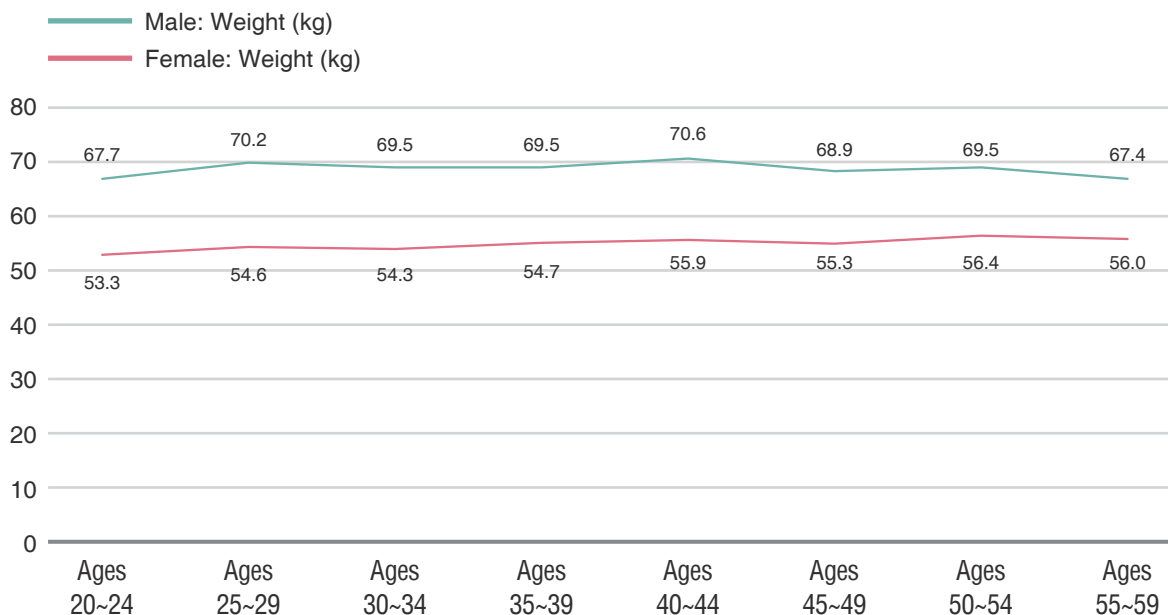

Figure 2-3-1-10 Average weight of male and female adults in each age group

The body mass index (BMI) is the value of body mass (kg) divided by height (m²), which is a universal measure to determine the level of fatness of individuals. According to the recommended standard of BMI classification by the China Obesity Problem Working Group, underweight is defined as having a BMI < 18.5, normal weight is defined as 18.5 ≤ BMI < 24.0, overweight is considered as 24.0 ≤ BMI < 28.0, and obesity is defined as BMI ≥ 28.0.

Between ages 20~54, BMI of male adults increased with advancing age, and then declined with age between ages 50~59. The highest BMI of 24.3 was recorded in the 50~54 year age group, while the lowest BMI of 22.6 was recorded in the 20~24 year age group. BMI of female adults increased generally with advancing age, and kept steady in the 25~34, 40~49 and 50~59 year age groups. The maximum BMI of 22.9 was found between 50~59 and the minimum BMI of 20.7 was in the 20~24 year age group. Males had a significantly higher BMI than females (P < 0.05) and the gender difference decreased as age increased, ranging from 1.1~2.2 (Figure 2-3-1-11, Table 3-3-3-5).

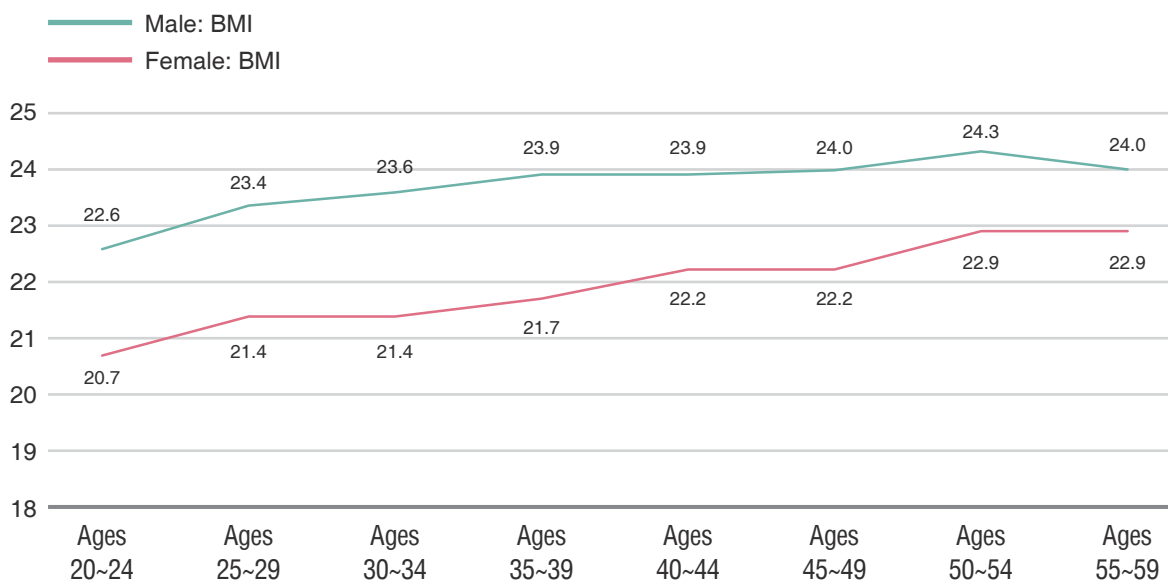

Figure 2-3-1-11 Average BMI of male and female adults in each age group

The proportion of Macao male adults with normal weight exceeded 50% in each age group, reaching a peak of 63.9% in the aged 20~24 group. The highest prevalence of underweight in males was 7.1%, also recorded in the aged 20~24 group, and no occurrence of underweight was observed among males aged 55~59. The prevalence of overweight and obesity peaked at 48.6% in males aged 50~54, and the prevalence of obesity peaked at 11.8% in males aged 40~44. For female adults, the proportion of those with normal weight exceeded 65% which was higher than that of males. The highest proportion of normal weight was 73.7% observed in the aged 45~49 group. The proportion of underweight peaked at 22.5% in females aged 20~24. The prevalence of overweight and obesity peaked at 33.5% in females aged 55~59. Males had a far lower underweight or normal weight proportion than females, whereas the prevalence of overweight and obesity in males was almost twice that of females (Table 3-3-3-6).

3.3 Circumference Indicators

Before age 55, waist circumference of male adults as well as chest and waist circumferences of female adults increased with advancing age, and remained stable thereafter. Chest circumference of males increased obviously in aged 20~29, and maintained steady afterwards. The average chest circumference for males and females ranged from 91.9~94.3cm and 83.2~88.3cm, and the average waist circumference for males and females ranged from 78~85.6cm and 70.5~81.0cm, respectively (Figures 2-3-1-12 and 2-3-1-13, Tables 3-3-3-7 and 3-3-3-8). Hip circumference of male adults increased with advancing age in aged 20~29, and remained fairly stable in aged 30~54, in which it slightly declined in aged 55~59. Hip circumference of female adults increased with advancing age in aged 20~44, and then varied little after aged 45. The average hip circumference of males and females ranged from 93.5~95.6cm and 92.5~94.7cm, respectively (Figure 2-3-1-14 and Table 3-3-3-9).

Chest and waist circumferences of males were higher than females, but the difference decreased as age increased. The difference between males and females ranged from 5.0~9.5cm for chest circumference and 3.5~8.7cm for waist circumference, with significant gender difference ($P < 0.05$). After aged 55, hip circumference of males was lower than that of females, with significant gender difference found in the 20~39 year age group ranging from 1.2~1.9cm ($P < 0.05$). The difference in other age groups were relatively small.

The waist-to-hip ratios (WHR) of males and females increased with advancing age, ranging from 0.835~0.904 and 0.761~0.862, respectively. The WHR of males was higher than that of females, with significant difference ranging from 0.042~0.074 ($P < 0.05$). This was probably due to a rather small difference in hip circumference between males and females, and a significantly higher waist circumference of males compared to females (Figure 2-3-1-15 and Table 3-3-3-10).

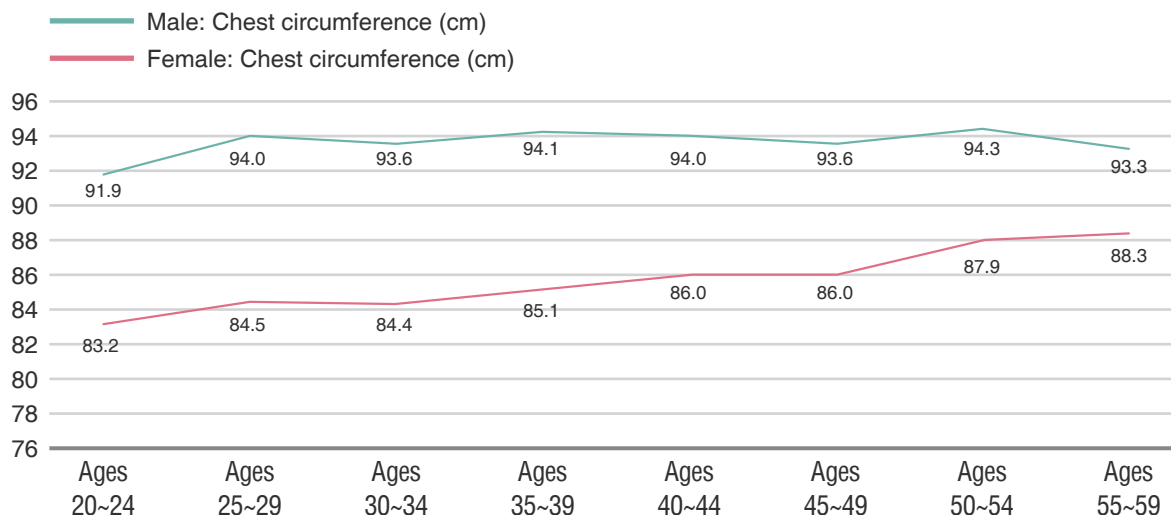

Figure 2-3-1-12 Average chest circumference of male and female adults in each age group

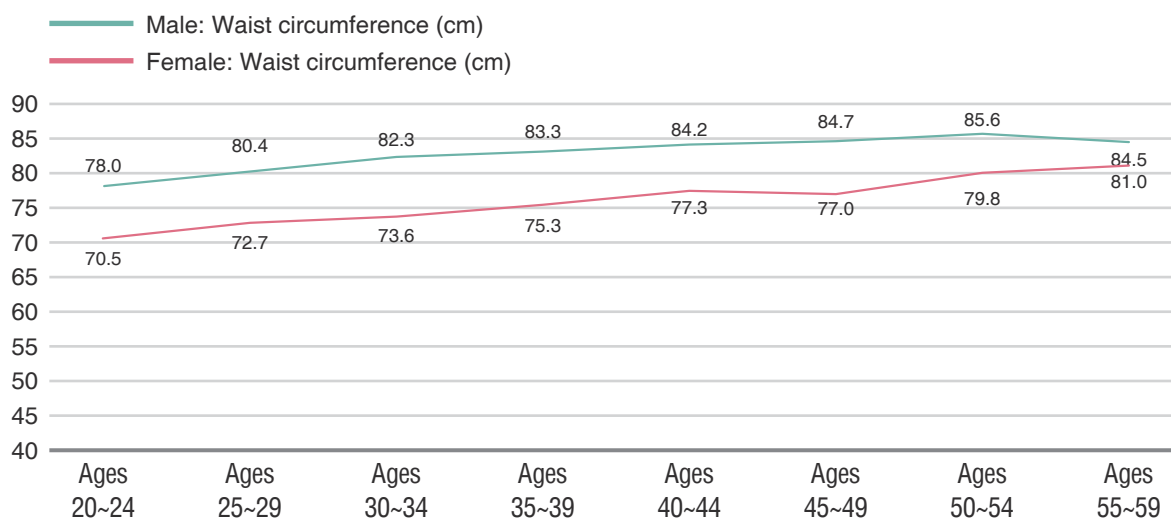

Figure 2-3-1-13 Average waist circumference of male and female adults in each age group

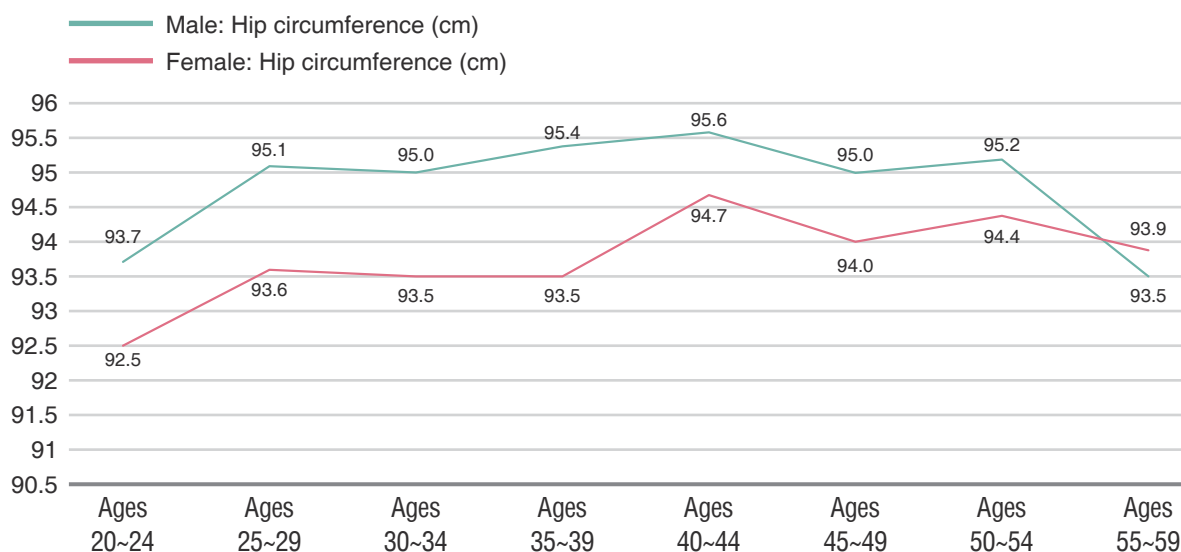

Figure 2-3-1-14 Average hip circumference of male and female adults in each age group

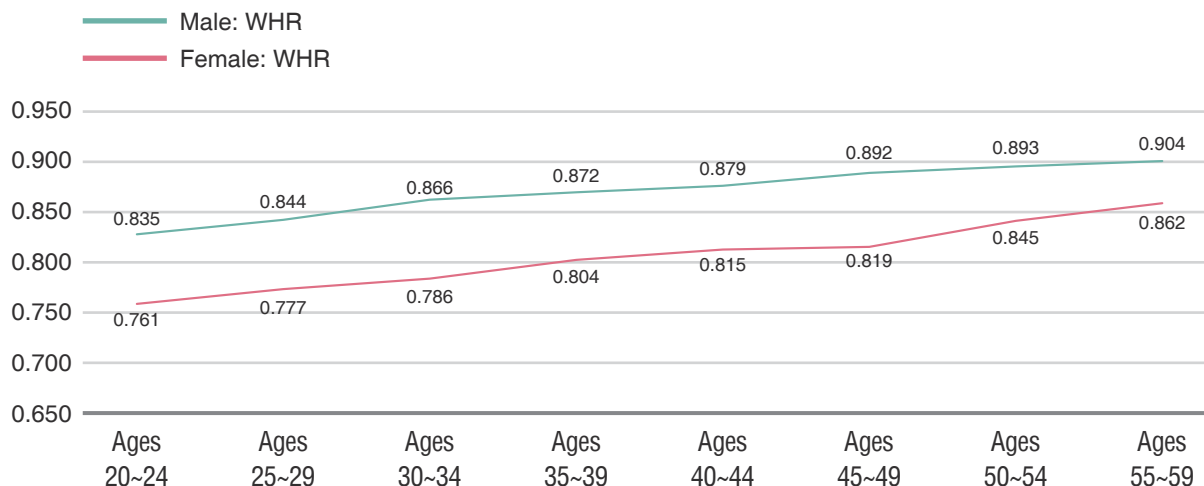

Figure 2-3-1-15 Average WHR of male and female adults in each age group

3.4 Width Indicators

The average shoulder width of male adults aged 20~34 increased then decreased as age progressed, with the highest value of 40.1cm recorded in the aged 25~29 group; the average shoulder width of males declined with advancing age between aged 40~59, ranging from 38.9~40.1cm. The average shoulder width of female adults varied mildly among age groups, ranging from 35.1~35.5cm. The shoulder width of males was 3.6~4.8cm wider than that of females ($P < 0.05$) (Figure 2-3-1-16 and Table 3-3-3-11).

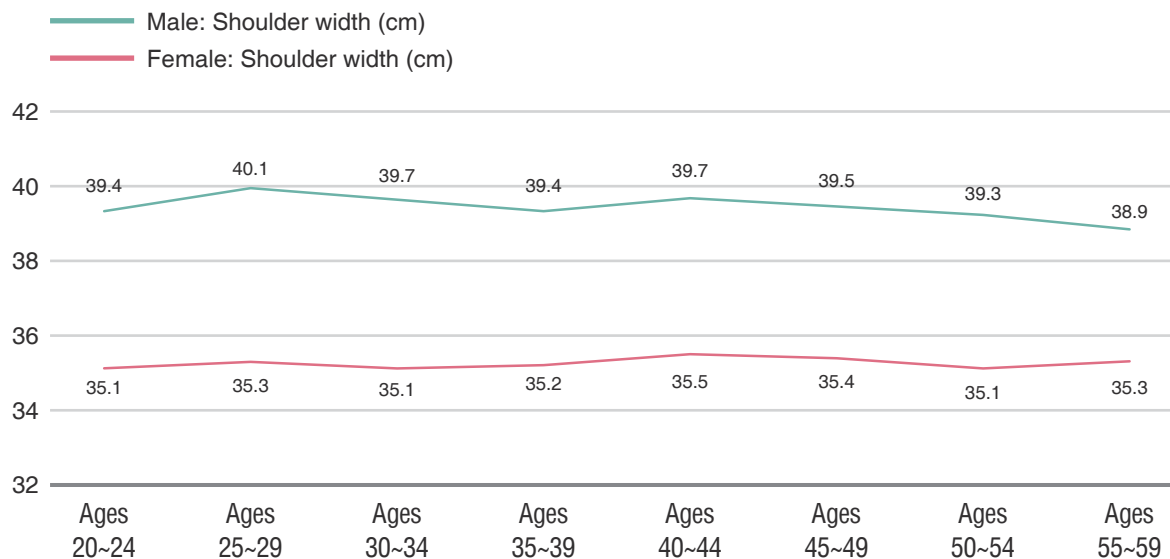

Figure 2-3-1-16 Average shoulder width of male and female adults in each age group

The average pelvis width of male adults aged 25~44 increased with advancing age, and that of males aged 45~49 was significantly reduced compared with that of males aged 40~44. The average pelvis width of males increased steadily between aged 45~59. For female adults, their average pelvis width increased with advancing age. The average pelvis width of males and females ranged from 28.2~28.9cm and 27.2~28.7cm, respectively. The average pelvis width of males was wider than that of females in the 20~54 year age groups, and this difference declined with advancing age. The average pelvis width differed significantly between genders in the 20~44 year age groups ($P < 0.05$), with the difference ranging from 0.6~1.0cm (Figure 2-3-1-17 and Table 3-3-3-12).

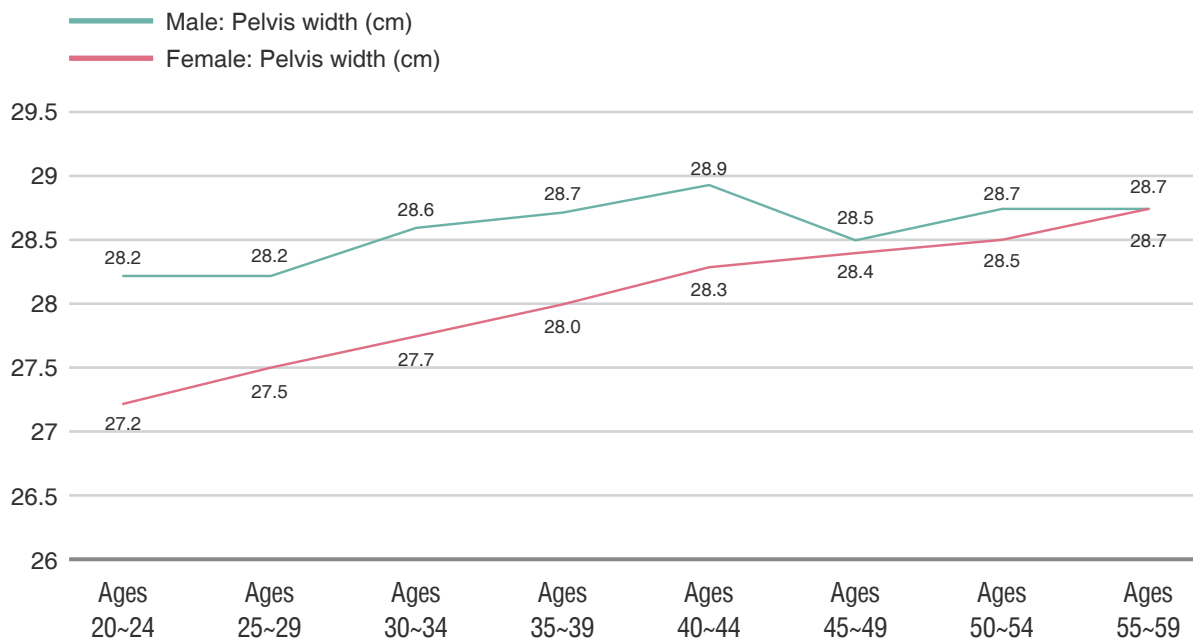

Figure 2-3-1-17 Average pelvis width of male and female adults in each age group

3.5 Body Composition

Body fat percentage of female adults increased with advancing age between aged 20~59 and peaked at 30.4% in aged 55~59. Body fat percentage of male adults increased with advancing age between ages 20~44, kept steady afterwards, and peaked at 22.8% between ages 50~54. The lowest body fat percentage was recorded in the aged 20~24 group for both males and females, which were 19.3% and 24%, respectively. Males had a significantly lower body fat percentage than females ($P < 0.05$), with the difference ranging from 4.3%~8.3%. (Figure 2-3-1-18 and Table 3-3-3-13).

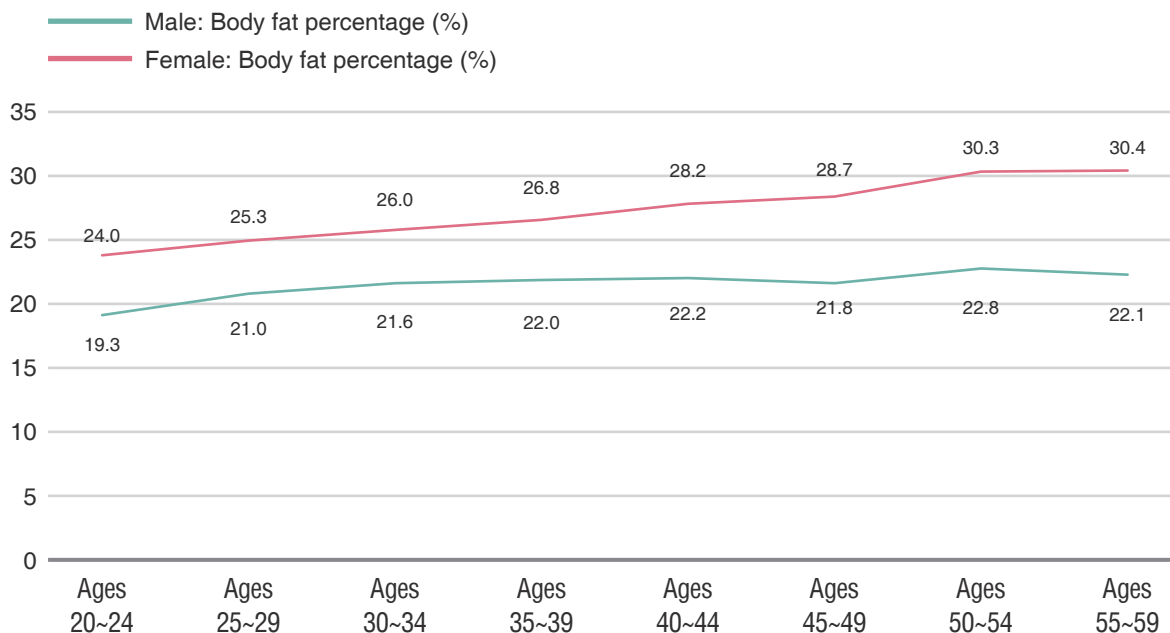

Figure 2-3-1-18 Average body fat percentage of male and female adults in each age group

Lean body mass of male and female adults was relatively steady, which varied little with advancing age, ranging from 52.2~54.9kg for males and 38.6~40.2kg for females. Lean body mass of males was significantly higher than that of females ($P < 0.05$), with the difference between genders ranging from 13.5~14.7kg (Figure 2-3-1-19 and Table 3-3-3-14).

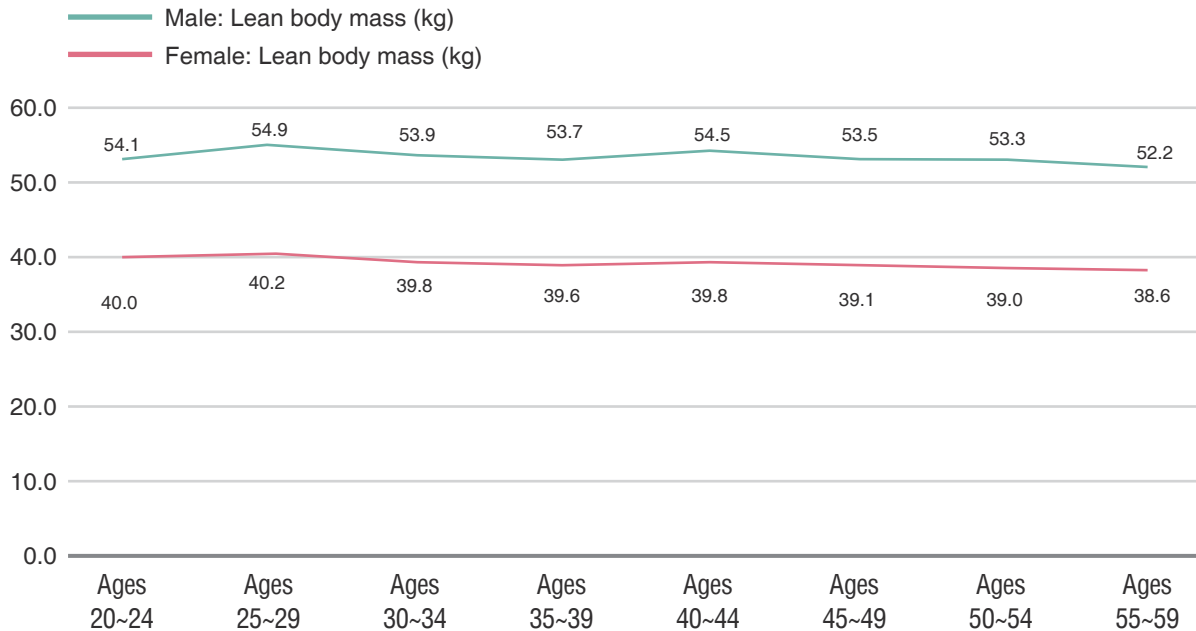

Figure 2-3-1-19 Average lean body mass of male and female adults in each age group

4. Physiological Function

4.1 Resting Pulse

The resting pulse of male adults varied irregularly, ranging from 69.2~72.9 bpm. The resting pulse of female adults decreased with advancing age before aged 55, ranging from 71.6~78.7 bpm. The resting pulse of females was significantly higher than that of males in the aged 20~49 and 55~59 groups ($P < 0.05$), and fairly similar to that of males in the aged 50~54 group (Figure 2-3-1-20 and Table 3-3-4-1).

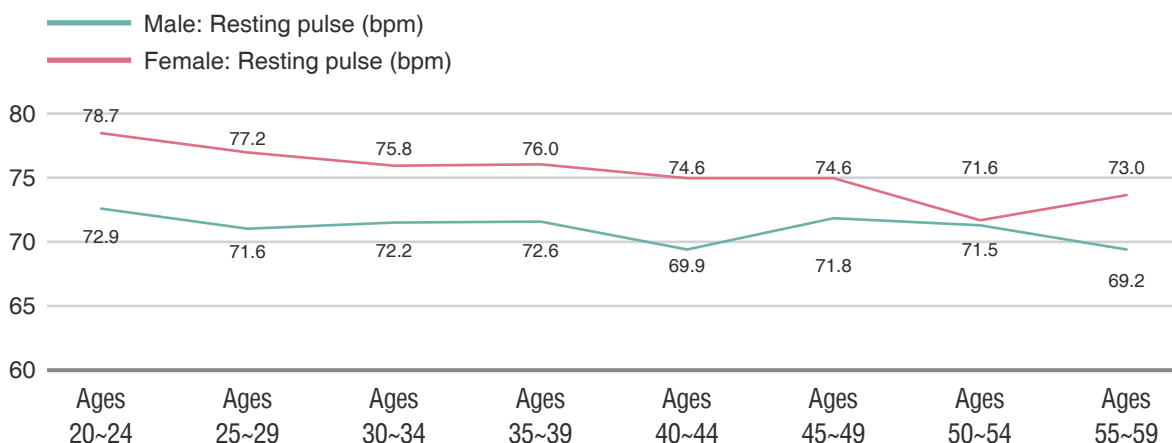

Figure 2-3-1-20 Average resting pulse of male and female adults in each age group

4.2 Blood Pressure

The systolic blood pressure (SBP) of male adults was relatively stable and varied little in each age group, while the SBP of female adults tended to increase slowly with advancing age. The SBP of males and females were 126.5~133.2 mmHg and 110.8~126.4 mmHg, respectively. The average SBP of males was usually higher than females, with significant gender difference ranging from 4.6~16.3 mmHg ($P < 0.05$) (Figure 2-3-1-21 and Table 3-3-4-2).

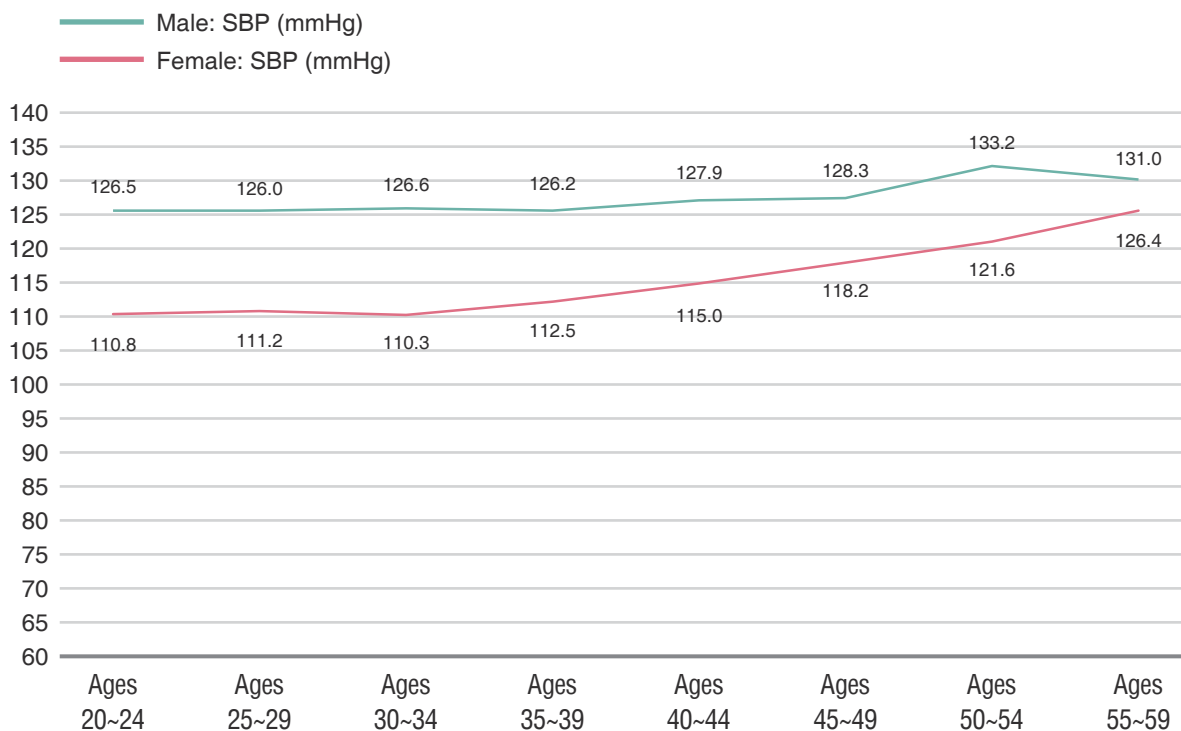

Figure 2-3-1-21 Average SBP of male and female adults in each age group

The diastolic blood pressure (DBP) of male adults increased with advancing age between aged 20~54, and then declined after aged 55; and that of female adults tended to increase slowly with advancing age. The DBP of males and females were 72.4~80.1 mmHg and 68.8~73.2 mmHg, respectively. Males had a significantly higher DBP than females ($P < 0.05$), with the difference between genders ranging from 3.5~7.7 mmHg (Figure 2-3-1-22 and Table 3-3-4-3).

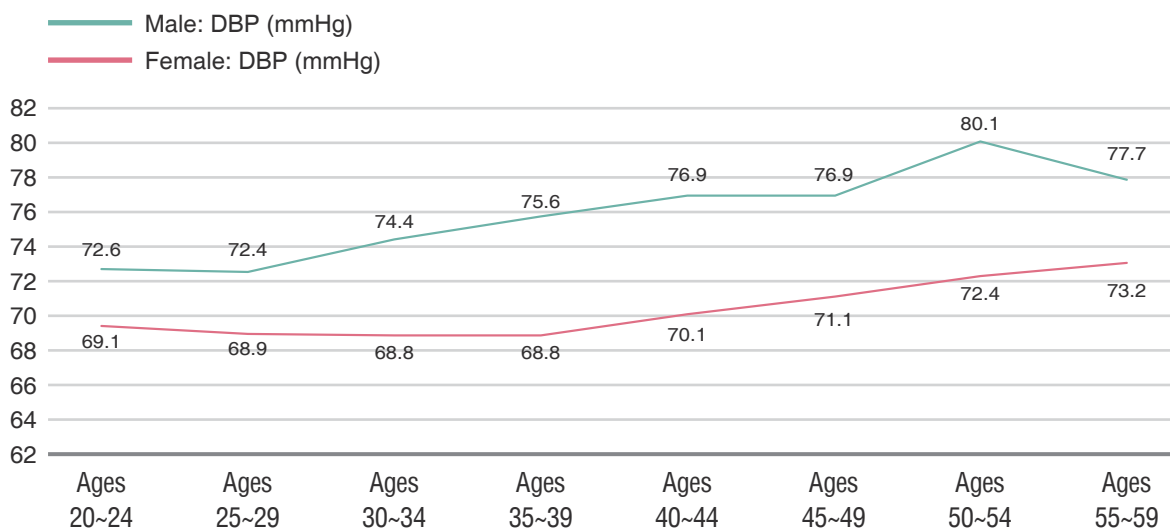

Figure 2-3-1-22 Average DBP of male and female adults in each age group

The difference of pulse pressure in male adults remained fairly stable as age increased, ranging from 50.6~53.9 mmHg; the difference of pulse pressure in female adults tended to increase slowly with advancing age, ranging from 41.6~53.2 mmHg. The difference in pulse pressure in males was significantly higher than that of females before aged 55 ($P < 0.05$), and the difference between males and females became increasingly smaller with advancing age. No significant gender difference was observed in the aged 55~59 group (Figure 2-3-1-23 and Table 3-3-4-4).

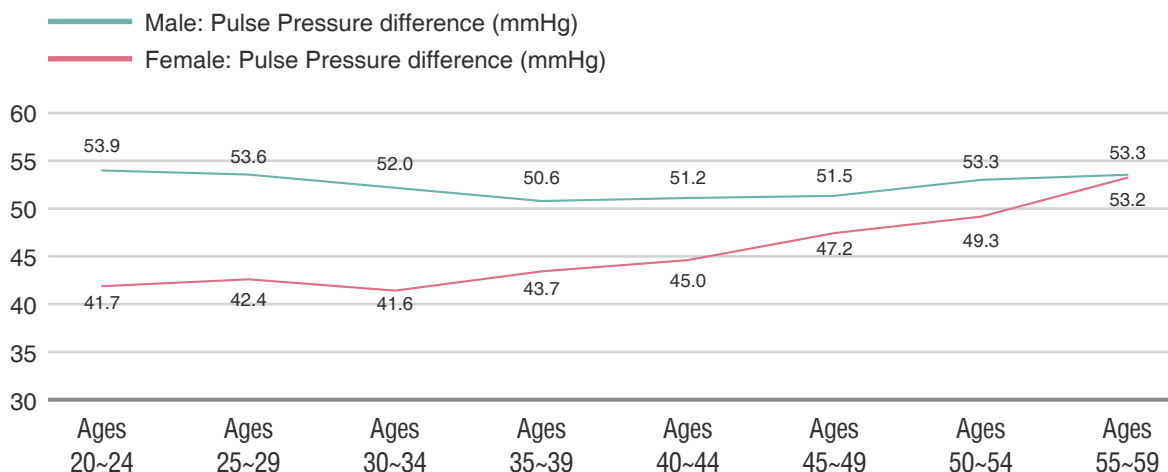

Figure 2-3-1-23 Average pulse pressure difference of male and female adults in each age group

4.3 Vital Capacity

The vital capacity of male and female adults aged 20~34 showed a relatively stable trend with mild change. The vital capacity of male and female adults aged 30~59 showed a decreasing trend as age increased. The vital capacity ranged from 3,423.8~4,058.1ml for males and 2,225~2,773.8ml for females. Males had a significantly higher vital capacity than females ($P < 0.05$), with difference between genders ranging from 1,091.2~1,389.5ml (Figure 2-3-1-24 and Table 3-3-4-5).

As age increased, the vital capacity/weight of male and female adults decreased, ranging from 51.4~60.7 ml/kg and 40.7~51.9 ml/kg, respectively. Males had a higher vital capacity/weight than females ($P < 0.05$), with significant gender difference ranging from 4.6~10.7 ml/kg (Figure 2-3-1-25 and Table 3-3-4-6).

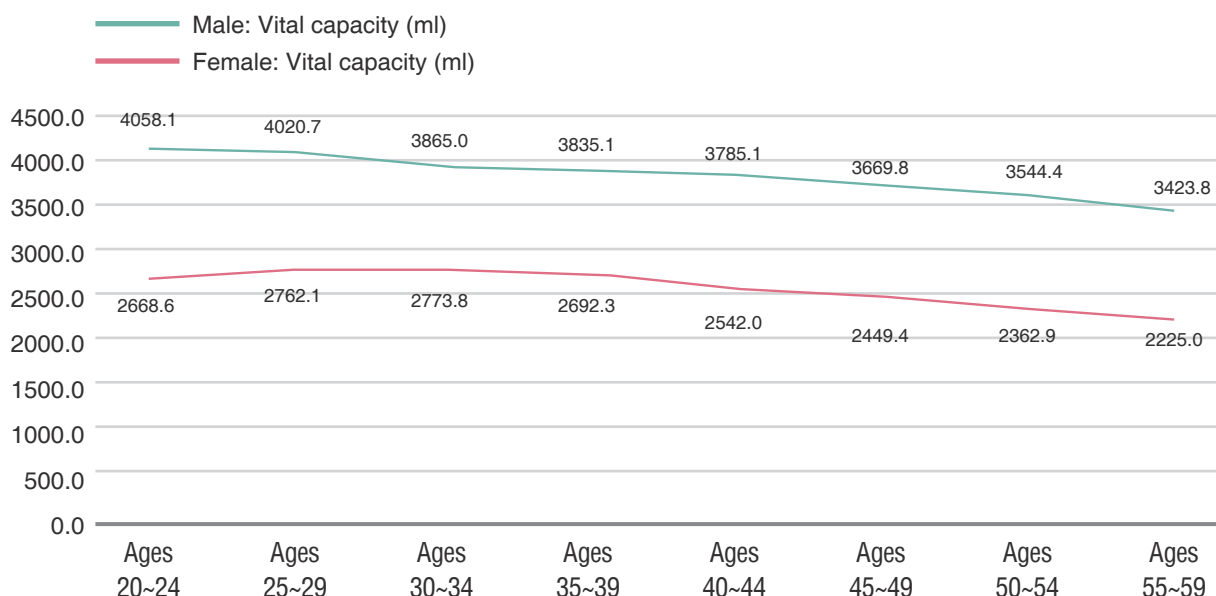

Figure 2-3-1-24 Average vital capacity of male and female adults in each age group

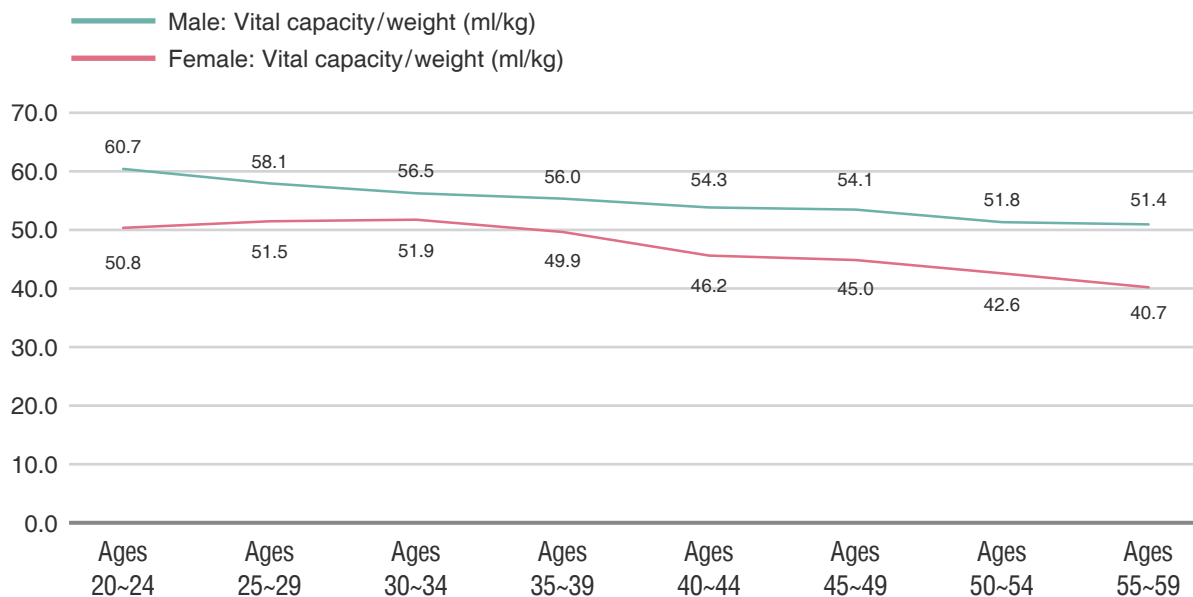

Figure 2-3-1-25 Average vital capacity/weight of male and female adults in each age group

4.4 Step Test Index

Step test is a simple quantitative load experiment used to evaluate cardiovascular function. By observing the relationship between exercising continuously in an established time, the cardiovascular respond and heart rate recovery speed after the exercise (step test index), the cardiovascular function can be assessed.

The step test index of male adults aged 20~59 increased with advancing age, while that of female adults remained fairly stable among age groups. The step test index ranged from 56.1~61.5 for males and 56.4~60.8 for females. The step test index was slightly higher in females than males between aged 25~54, with no significant difference between genders (Figure 2-3-1-26 and Table 3-3-4-7).

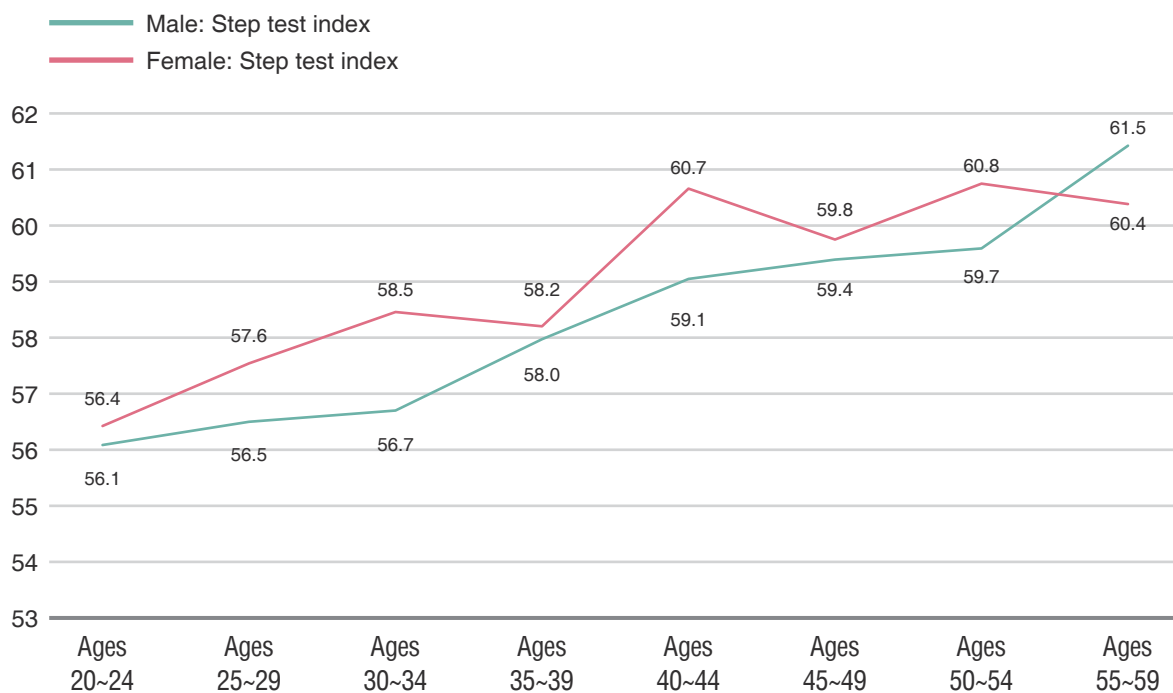

Figure 2-3-1-26 Average step test index of male and female adults in each age group

4.5 Submaximal Bicycle Ergometer Exercise Test

Submaximal bicycle ergometer exercise test is used to indirectly predict the maximal oxygen consumption of subjects. It evaluates the cardiopulmonary function of subjects by estimating the maximal oxygen uptake based on heart rate and cardiac output through incremental load and submaximum programme, which is one of the best experimental methods for large-scale research of the VO_2 max data. As an optional test, subjects had to complete the sports risk screening questionnaire and was deemed suitable before volunteering for the test. The results showed that the cardiopulmonary endurance of males aged 20~39 was lower than that of females, but statistically significant difference was only observed in the aged 25~29 group ($P < 0.05$). The cardiopulmonary endurance of males was significantly higher than that of females in aged 40~59 ($P < 0.05$) (Figure 2-3-1-27 and Table 3-3-4-8).

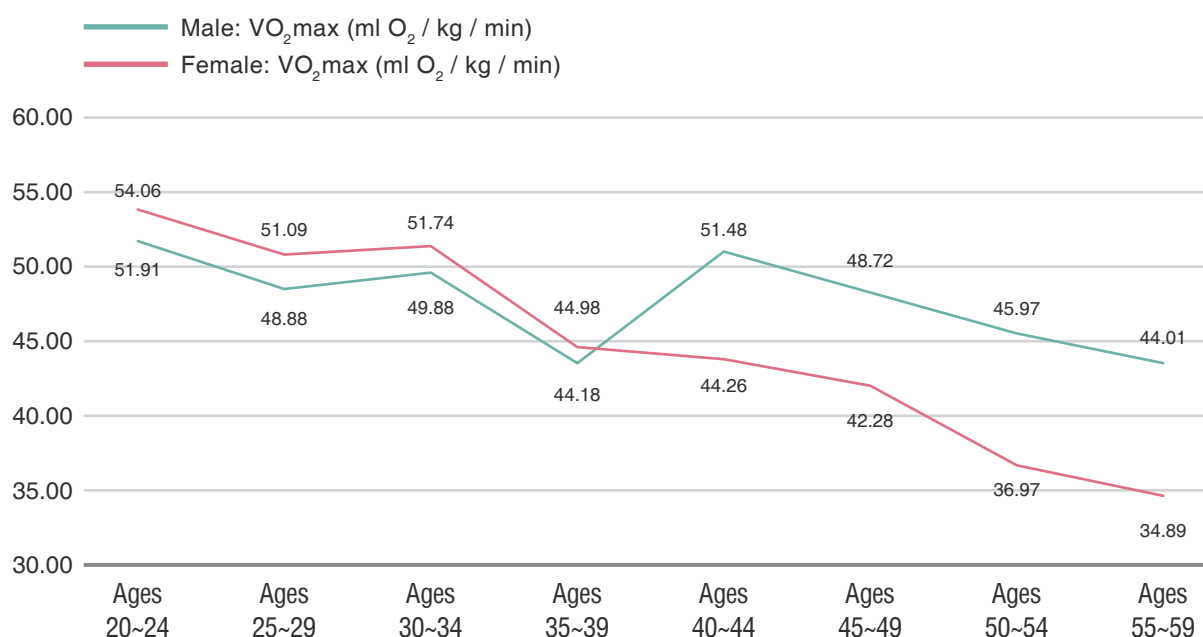

Figure 2-3-1-27 Average maximal oxygen consumption of male and female adults in each age group

5. Physical Fitness

5.1 Strength

Strength of adults in age groups below 39 years old was reflected by four different indicators, i.e. vertical jump, push-ups (male)/one-minute sit-ups (female), grip strength and back strength. Among all, push-ups (male)/one-minute sit-ups (female) reflected strength endurance of individuals and grip strength reflected strength of adults aged 40 onwards.

Vertical jumps peaked in the aged 20~24 group for both males and females, one-minute sit-ups (female) also peaked in the aged 20~24 group. As for push-ups (male), it reached the peak in the aged 25~29 group and afterwards decreased with advancing age (Figures 2-3-1-28 and 2-3-1-29). Grip strength of males stayed relatively stable before aged 54 and tended to decline thereafter between aged 55~59; grip strength of females became stable with advancing age before aged 44 and then dropped after aged 45. Back strength of males decreased gradually with advancing age except for an increase observed between aged 20~29. As age increased, back strength of females remained relatively stable among age groups (Figures 2-3-1-30 and 2-3-1-31).

The indicators for vertical jump, push-ups, grip strength and back strength in males ranged from 34.6~38.6cm, 26.4~31.7 times, 38.6~41.4kg and 106.8~118.2kg, respectively. For females, the indicators for vertical jump, one-minute sit-ups, grip strength and back strength ranged from 23.2~24.7cm, 22.5~26.6 times/minute, 22.1~24.1kg and 58.3~61.2kg, respectively. Males were generally stronger than females, with significant gender difference observed ($P < 0.05$) (Tables 3-3-5-1, 3-3-5-2, 3-3-5-3 and 3-3-5-4).

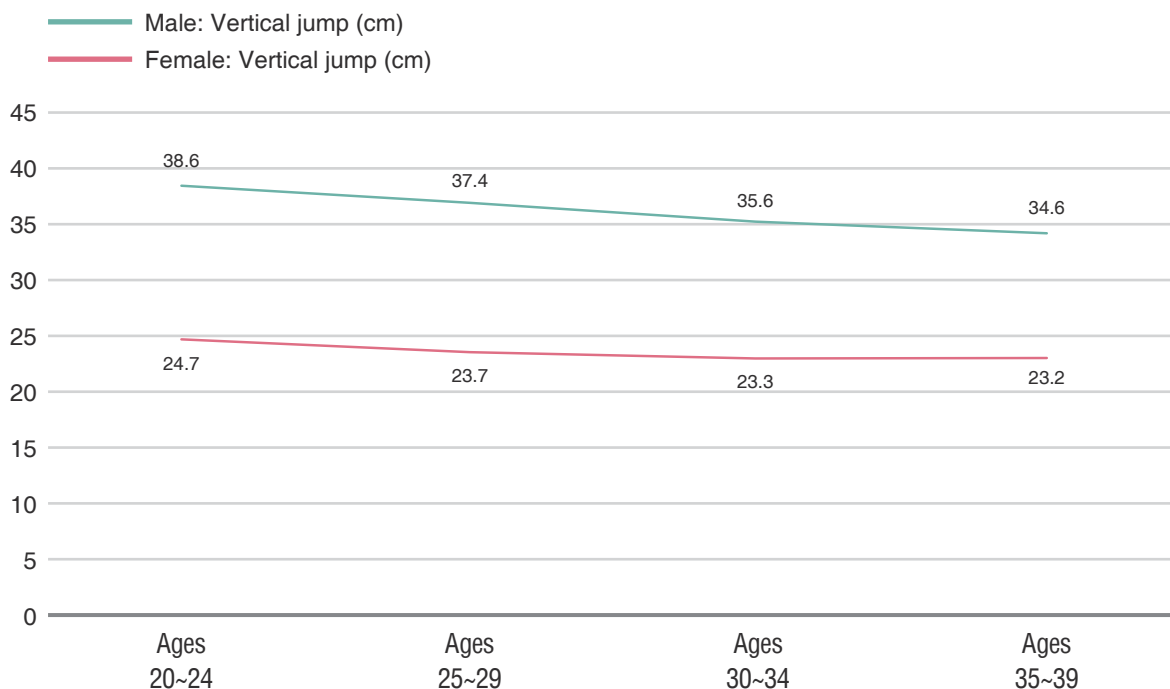

Figure 2-3-1-28 Average vertical jump of male and female adults in each age group

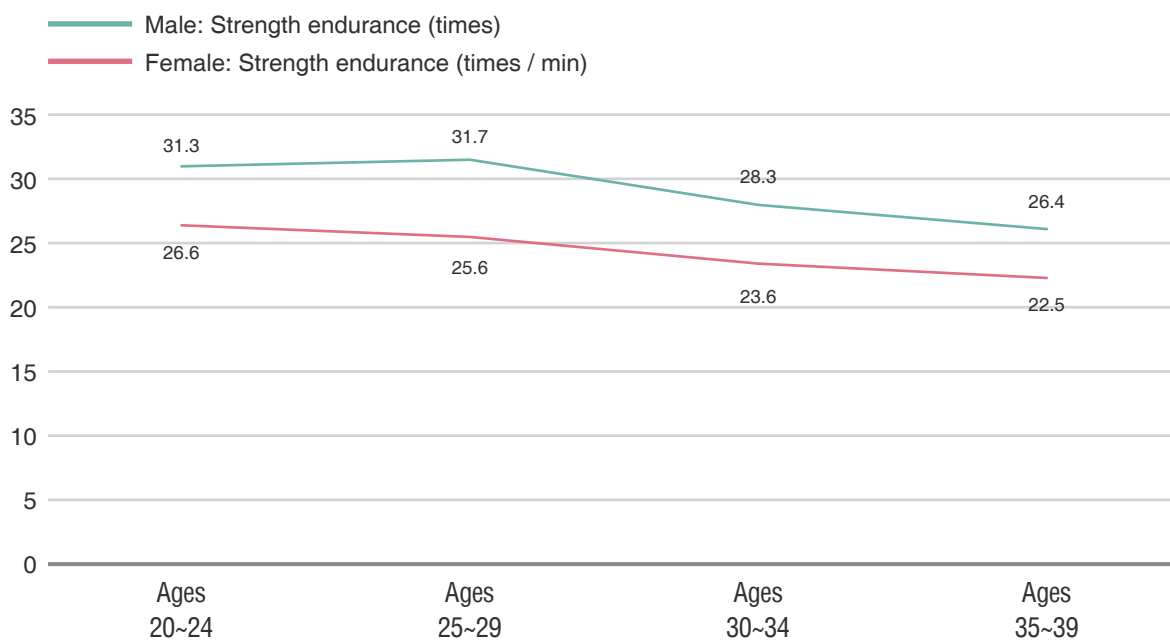

Figure 2-3-1-29 Average push-ups (male) / one-minute sit-ups (female) of male and female adults in each age group

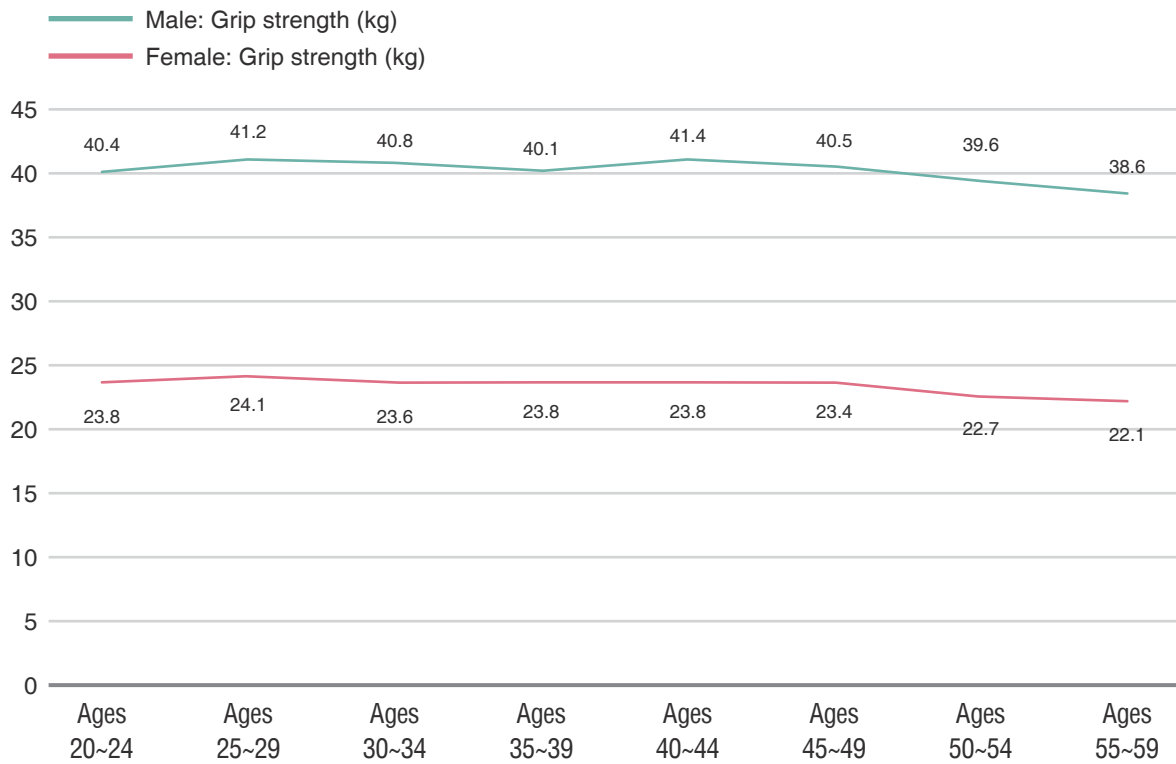

Figure 2-3-1-30 Average grip strength of male and female adults in each age group

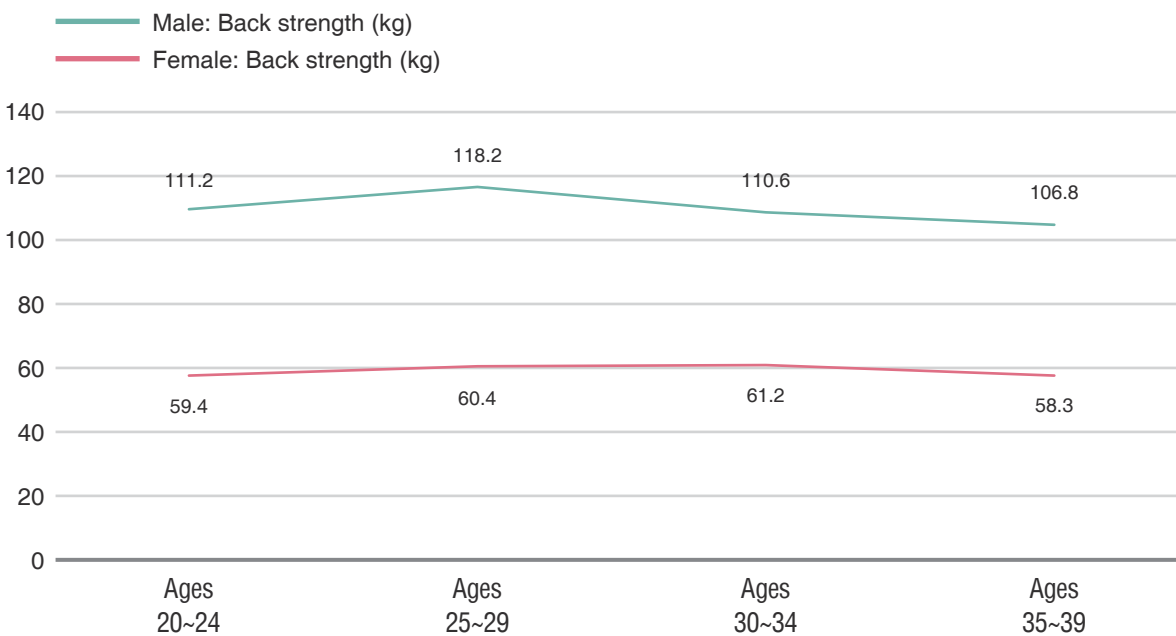

Figure 2-3-1-31 Average back strength of male and female adults in each age group

5.2 Flexibility

Sit and reach reflects flexibility. The sit and reach for males between aged 20~54 decreased as age increased and increased slightly after aged 54, with no statistically significant difference among age groups. The sit and reach for females between aged 25~44 decreased with advancing age. The difference ranged from -0.6~2.9cm and 6.2~9.6cm for males and females, respectively (Table 3-3-5-5).

The sit and reach for females was higher than that for males in each age group ($P < 0.05$), with the biggest difference of 7.3cm observed in the 45~49 year age group (Figure 2-3-1-32).

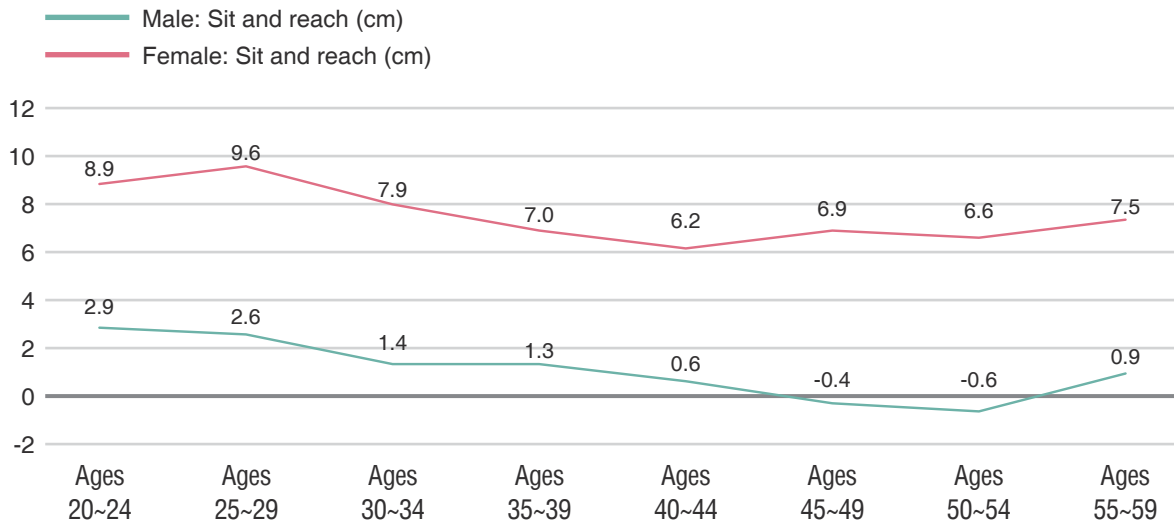

Figure 2-3-1-32 Average sit and reach of male and female adults in each age group

5.3 Reaction

Choice reaction time reflects reaction. Choice reaction time for male and female adults tended to decrease with advancing age and the rate of decrease was generally the same for both genders. Both males and females had the shortest reaction time in aged 20~24 and the longest time in aged 55~59. The reaction time for males and females ranged from 0.39~0.46 seconds and 0.44~0.50 seconds, respectively (Table 3-3-5-6). Males generally had a faster reaction time than females and the difference between genders was significant ($P < 0.05$) (Figure 2-3-1-33).

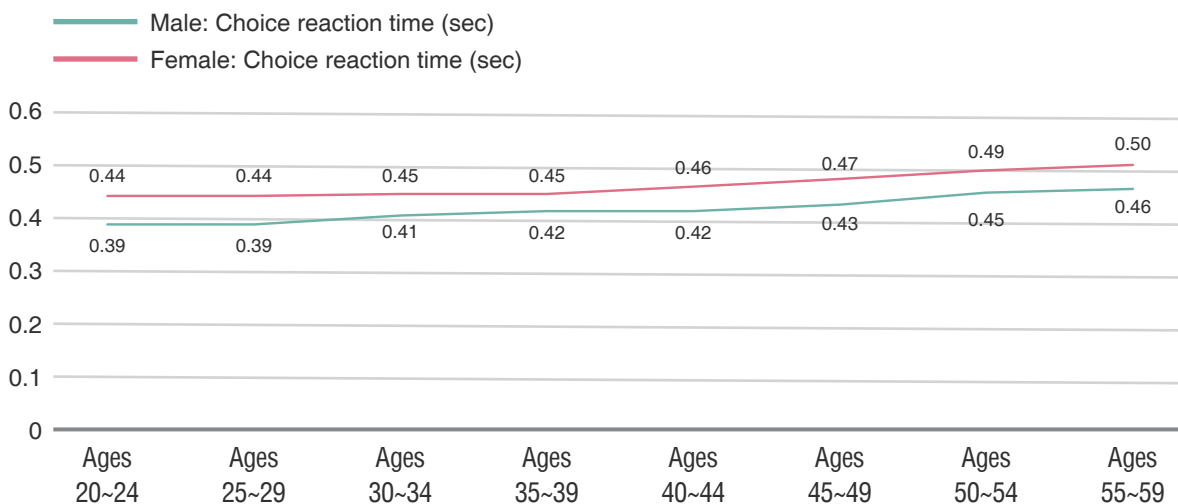

Figure 2-3-1-33 Average choice reaction time of male and female adults in each age group

5.4 Balance

One foot stands with eyes closed (OFSEC) reflects balance. The OFSEC time for males and females showed a descending trend with advancing age. The longest balance time for males and females occurred in the 25~29 year age group and the 30~34 year age group, respectively; whereas the shortest time for both genders occurred in the 55~59 year age group (Table 3-3-5-7). The average OFSEC time ranged from 17.5~44.8 seconds for males and 17.8~44.9 seconds for females. Only small difference was seen between genders in balance (Figure 2-3-1-34).

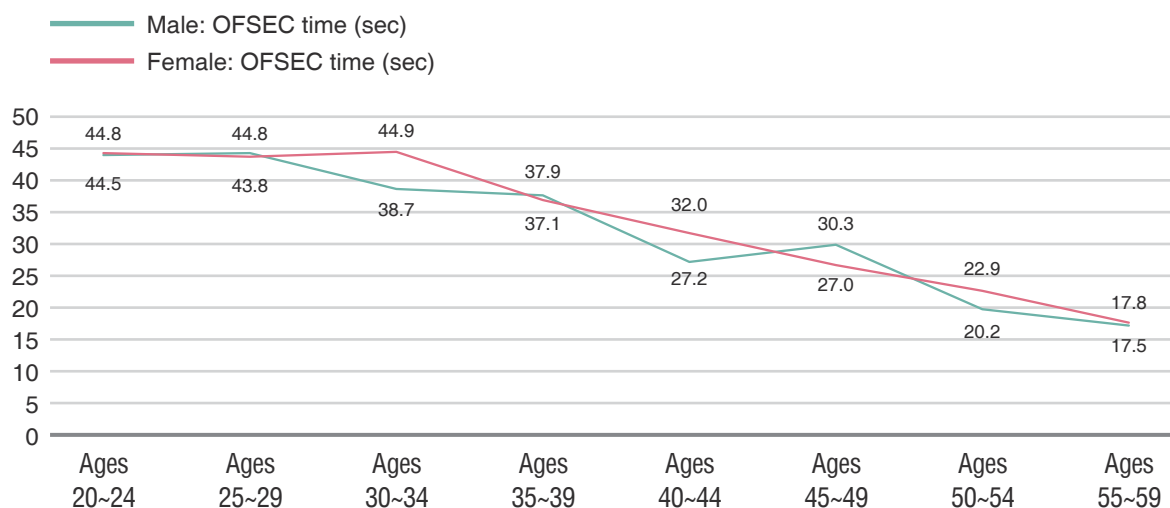

Figure 2-3-1-34 Average OFSEC time of male and female adults in each age group

(II) Comparison of 2020 and 2015 Results on the Physical Fitness Study of Macao Adults

1. Overall Comparison of Adults by Age

1.1 Comparison of Basic Information

In 2020, the total number of adult subjects was 3,892, which was more than 3,290 subjects in 2015. Compared with the results in 2015, the proportion of adults born in Mainland China decreased substantially and those born in Macao increased significantly, especially that of males. The proportion of males born in Mainland China decreased by 8.8% ($P < 0.05$) and that of females decreased by 4.6% ($P < 0.05$); whereas the proportion of males born in Macao increased by 8.8% ($P < 0.05$) and that of females increased by 4.2% ($P < 0.05$). The proportion of adults born in Hong Kong, Portugal and other places changed slightly (Table 2-3-2-1).

Table 2-3-2-1 Comparison of birthplaces in male and female adults (%)

Birthplace	Male			Female		
	2020	2015	Difference	2020	2015	Difference
Mainland China	23.1	31.9	-8.8*	32.1	36.7	-4.6*
Macao	69.1	60.3	8.8*	61.4	57.2	4.2*
Hong Kong	4.6	3.8	0.8	3.7	3.4	0.3
Portugal	0.2	0.4	-0.2	0.1	0.1	0.0
Others	3.1	3.6	-0.5	2.6	2.6	0.0

Note: Difference is calculated using the 2015 data deducted from 2020 data.
The asterisk “*” means $P < 0.05$, which applies to subsequent tables.

In terms of comparison of educational level between 2020 and 2015, significant decrease was seen in the proportion of males and females with secondary education or below ($P < 0.05$), males with post-secondary education and master's degree, as well as females with post-secondary education or above increased significantly ($P < 0.05$) (Table 2-3-2-2).

Table 2-3-2-2 Comparison of educational levels in male and female adults (%)

Education level	Male			Female		
	2020	2015	Difference	2020	2015	Difference
Below primary school education level	0.3	1.0	-0.7*	0.8	2.1	-1.3*
Primary school	3.4	6.8	-3.4*	2.6	7.4	-4.8*
Secondary school	20.3	31.4	-11.1*	20.7	25.8	-5.1*
Post-secondary education	62.2	48.6	13.6*	60.1	51.6	8.5*
Master	12.6	10.8	1.8*	15.1	12.8	2.3*
Doctoral	1.3	1.5	-0.2	0.5	0.3	0.2*

1.2 Comparison of Lifestyle

In our study, lifestyle information of adults was examined, four areas including living habits, physical exercise, occurrence of diseases and perception of the physical fitness study. Comparison of the results in 2020 and 2015 were as follows:

1.2.1 Living Habits

Compared with the results in 2015, the proportion of female adults who sleep for less than 6 hours (including naps) decreased substantially in 2020 ($P < 0.05$) and the proportion of those who sleep for 6~9 hours increased significantly ($P < 0.05$), showing that the sleeping time of adults in Macao has increased in 2020 (Table 2-3-2-3).

Table 2-3-2-3 Comparison of average daily sleep time (including naps) in male and female adults (%)

Sleeping time	Male			Female		
	2020	2015	Difference	2020	2015	Difference
Less than 6 hours	3.2	13.1	-9.9*	5.4	16.4	-11.0*
6~9 hours	91.6	84.8	6.8*	89.0	81.6	7.4*
9 hours or more	5.2	2.1	3.1	5.6	2.0	3.6

The proportion of adults with an average sitting time of less than 3 hours and 3~6 hours per day ($P < 0.05$) has decreased significantly, while those with sitting time of 6 hours or more has increased significantly ($P < 0.05$) (Table 2-3-2-4).

Table 2-3-2-4 Comparison of average daily accumulated sitting hours in male and female adults (%)

Average accumulated sitting time	Male			Female		
	2020	2015	Difference	2020	2015	Difference
Less than 3 hours	6.0	14.2	-8.2*	5.4	10.8	-5.4*
3~6 hours	26.0	38.9	-12.9*	22.7	35.8	-13.1*
6~9 hours	42.8	30.2	12.6*	41.6	30.6	11.0*
9~12 hours	15.7	13.7	2.0*	16.9	17.7	-0.8
12 hours or more	9.5	3.0	6.5*	13.5	5.2	8.3*

1.2.2 Physical Exercise

In 2020, 36.1% of adult subjects participated in physical exercise frequently, which is increased by 20.1% from 16.0% in 2015, indicating that there was an improvement in the popularity and promotion of Sports for All in Macao.

In terms of comparison of weekly exercise frequency, the proportion of males who exercise two times or less per week decreased, and those who exercise three times or more per week increased. The proportion of females who exercise less than one time a week and never exercise decreased significantly, and those who exercise one time or more per week increased significantly ($P < 0.05$) (Table 2-3-2-5).

Table 2-3-2-5 Comparison of weekly exercise frequency in male and female adults (%)

Exercise frequency	Male			Female		
	2020	2015	Difference	2020	2015	Difference
Never	4.8	18.6	-13.8*	6.8	27.8	-21.0*
Less than 1 time	13.1	21.9	-8.8*	18.9	23.3	-4.4*
1~2 times	30.5	34.6	-4.1*	33.7	27.5	6.2*
3~4 times	29.3	17.3	12.0*	23.2	12.5	10.7*
5 times or more	22.4	7.5	14.9*	17.5	8.8	8.7*

Comparison of each exercise duration and exercise intensity indicated that the proportion of male and female adults who exercise for less than 30 minutes and 30~60 minutes decreased significantly ($P < 0.05$), whereas the proportion of those who exercise for 60 minutes or more increased remarkably ($P < 0.05$), showing an increase observed in each exercise duration. In terms of exercise intensity, the proportion of males and females who do moderate and low intensity exercises decreased significantly ($P < 0.05$), whereas the proportion of those who do high intensity exercises increased considerably ($P < 0.05$) (Table 2-3-2-6).

Table 2-3-2-6 Comparison of exercise duration and self-perception in male and female adults (%)

Exercise duration and self-perception	Male			Female		
	2020	2015	Difference	2020	2015	Difference
Less than 30 minutes	19.3	27.9	-8.6*	24.1	35.1	-11.0*
30~60 minutes	41.6	46.0	-4.4*	44.8	48.1	-3.3*
60 minutes or more	39.1	26.1	13.0*	31.1	16.8	14.3*
Breathing & heart rate remained almost constant	4.5	11.9	-7.4*	6.3	15.2	-8.9*
Slightly increased breathing & heart rate and perspiring slightly	36.4	46.9	-10.5*	53.6	62.3	-8.7*
Significantly increased breathing & heart rate and perspiring greatly	59.1	41.2	17.9*	40.1	22.5	17.6*

In terms of comparison of exercise persistence and obstacles that hinder exercise participation, the proportion of males who persisted in exercising for less than 6 months increased, whereas those who persisted in exercising for one year or more decreased. For females, the proportion increased significantly in those who persisted in exercising for 6~12 months ($P < 0.05$). Besides, the proportion of males who did not exercise due to a lack of interest decreased considerably ($P < 0.05$), but the proportion increased significantly in those due to a lack of

time, venues and facilities, coaching advice as well as due to financial restraint ($P < 0.05$). For females, the proportion of those who were hindered in exercise participation due to lack of venues and facilities decreased significantly ($P < 0.05$), whereas the proportion increased significantly in those due to a lack of interest, time, coaching advice and organization as well as due to financial restraint ($P < 0.05$) (Tables 2-3-2-7 and 2-3-2-8).

Table 2-3-2-7 Comparison of duration of persistent exercising in male and female adults (%)

Duration of persistent exercising	Male			Female		
	2020	2015	Difference	2020	2015	Difference
Less than 6 months	36.7	32.9	3.8*	45.6	46.3	-0.7
6~12 months	15.5	15.6	-0.1	14.2	12.5	1.7*
1 year or more	47.9	51.4	-3.5*	40.2	41.2	-1.0

Table 2-3-2-8 Comparison of obstacles to participating in physical exercise in male and female adults (%)

Obstacles	Male			Female		
	2020	2015	Difference	2020	2015	Difference
Lack of interest	8.4	11.5	-3.1*	13.9	10.9	3.0*
Lack of time	77.1	59.4	17.7*	69.1	57.5	11.6*
Lack of venues and facilities	35.4	29.6	5.8*	23.0	24.9	-1.9*
Lack of coaching advice	21.1	11.7	9.4*	29.9	11.3	18.6*
Lack of organization	12.5	13.1	-0.6	13.4	8.9	4.5*
Financial restraint	6.7	3.0	3.7*	6.4	1.6	4.8*

1.2.3 Occurrence of Diseases and Perception of the Physical Fitness Study

In 2020, 42.5% of adult subjects had been diagnosed with diseases in the past five years, which was higher than the proportion in 2015.

Compared with the results in 2015, a significant decrease was seen in the proportion of adults who had heard of and previously participated in the physical fitness study ($P < 0.05$). In terms of perception of the physical fitness study, the proportion increased significantly in adults who perceived the “physical fitness study” as “recognizing the importance of physical exercise” and “improving knowledge of scientific fitness”, and the proportion decreased significantly in those who considered it “meaningless” ($P < 0.05$). Besides, the proportion of males who perceived the “physical fitness study” as “understanding their own physical fitness status” also increased substantially ($P < 0.05$) (Tables 2-3-2-9 and 2-3-2-10).

Table 2-3-2-9 Comparison of adults who had heard of or participated in the physical fitness study (%)

Heard of or participation status	Male			Female		
	2020	2015	Difference	2020	2015	Difference
Heard of	63.3	66.5	-3.2*	61.2	71.1	-9.9*
Never heard of	36.7	33.5	3.2*	38.8	28.9	9.9*
Participated previously	24.5	34.8	-10.3*	26.6	33.2	-6.6*
Never participated	75.5	65.2	10.3*	73.4	66.8	6.6*

Table 2-3-2-10 Comparison of perception of the physical fitness study in male and female adults (%)

Perception of the physical fitness study	Male			Female		
	2020	2015	Difference	2020	2015	Difference
Meaningless	2.7	5.7	-3.0*	2.2	3.1	-0.9*
Understand the physical fitness status of oneself	96.9	92.3	4.6*	97.3	95.9	1.4
Recognize the importance of physical exercise	80.6	55.7	24.9*	82.3	53.1	29.2*
Improve knowledge of scientific fitness	73.0	45.9	27.1*	74.7	41.6	33.1*

1.3 Comparison of Study Indicators

Compared with the results in 2015, indicators including push-ups, step test index, back strength, OFSEC, choice reaction time, pelvis width, chest circumference and hip circumference of male adults aged 20~39 all increased in 2020, with the difference ranging from 2.1%~7.3%. Indicators including waist circumference, vital capacity, sit and reach, diastolic blood pressure, resting pulse and grip strength decreased ranging from 1.2%~7.9%, with the largest reduction of 7.9% recorded in grip strength, and other indicators varied within 1.0% (Figure 2-3-2-1). For females aged 20~39, indicators including sit-ups, sit and reach, OFSEC, back strength, step test index, choice reaction time, shoulder width, pelvis width, hip circumference, chest circumference, waist circumference, weight, systolic and diastolic blood pressure increased by 0.9%~12.8% in 2020. Indicators including vertical jump, resting pulse and grip strength decreased by 0.8%~4.4% (Figure 2-3-2-2).

For male adults aged 40~59, indicators including step test index, vital capacity, pelvis width, hip circumference, weight and chest circumferences increased by 1.3%~6.9% in 2020, and the indicators of resting pulse, sit and reach, one foot stands with eyes closed and grip strength decreased by 4.7%~9.7%, other indicators varied within 1.0% (Figure 2-3-2-3). For females aged 40~59, indicators including one foot stands with eyes closed, choice reaction time, step test index, shoulder width, pelvis width and sit and reach increased by 1.5%~10.8% in 2020, while indicators including resting pulse, weight, BMI and grip strength decreased by 1.7%~7.6%, other indicators varied within 1.0% (Figure 2-3-2-4).

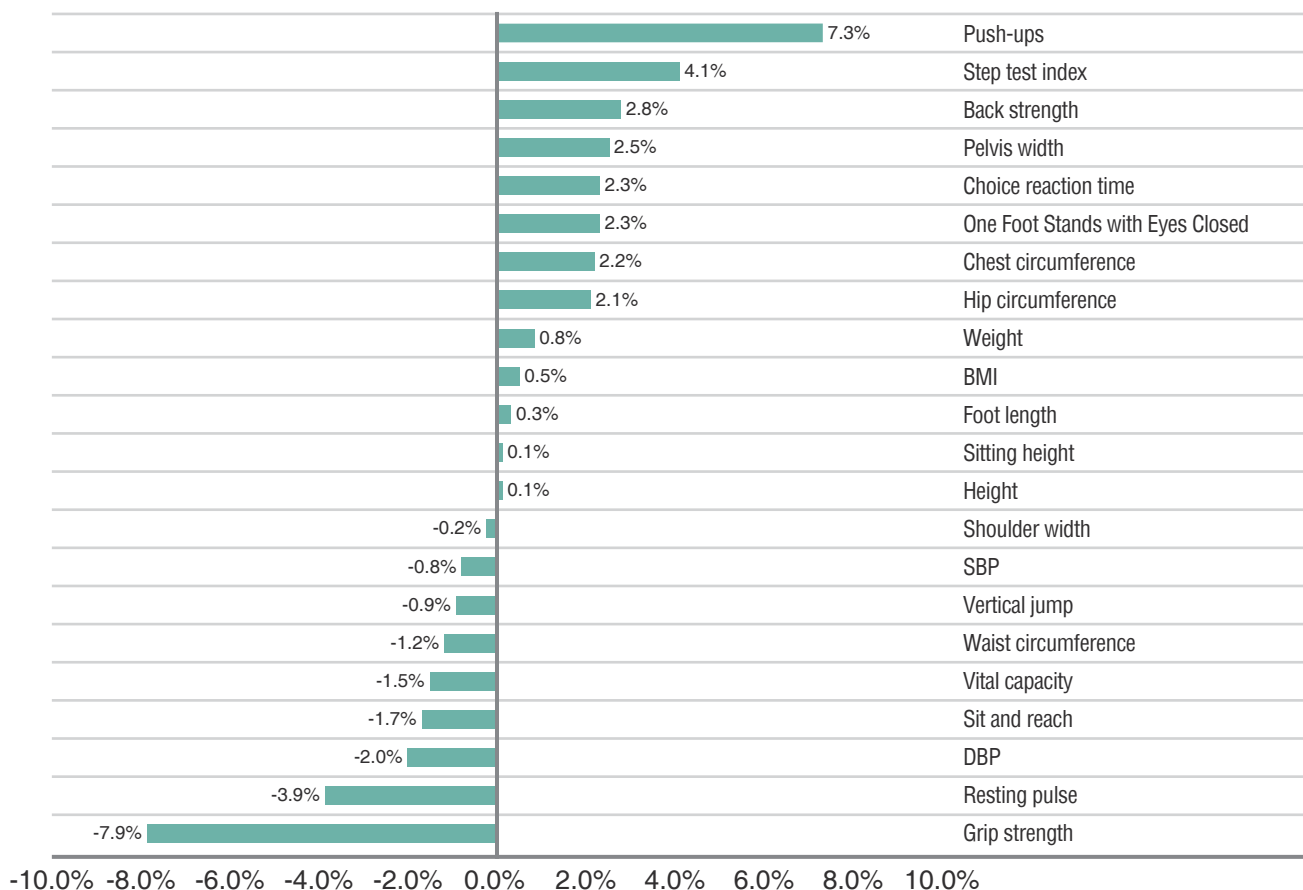

Figure 2-3-2-1 Comparison of study indicators in male adults aged 20~39

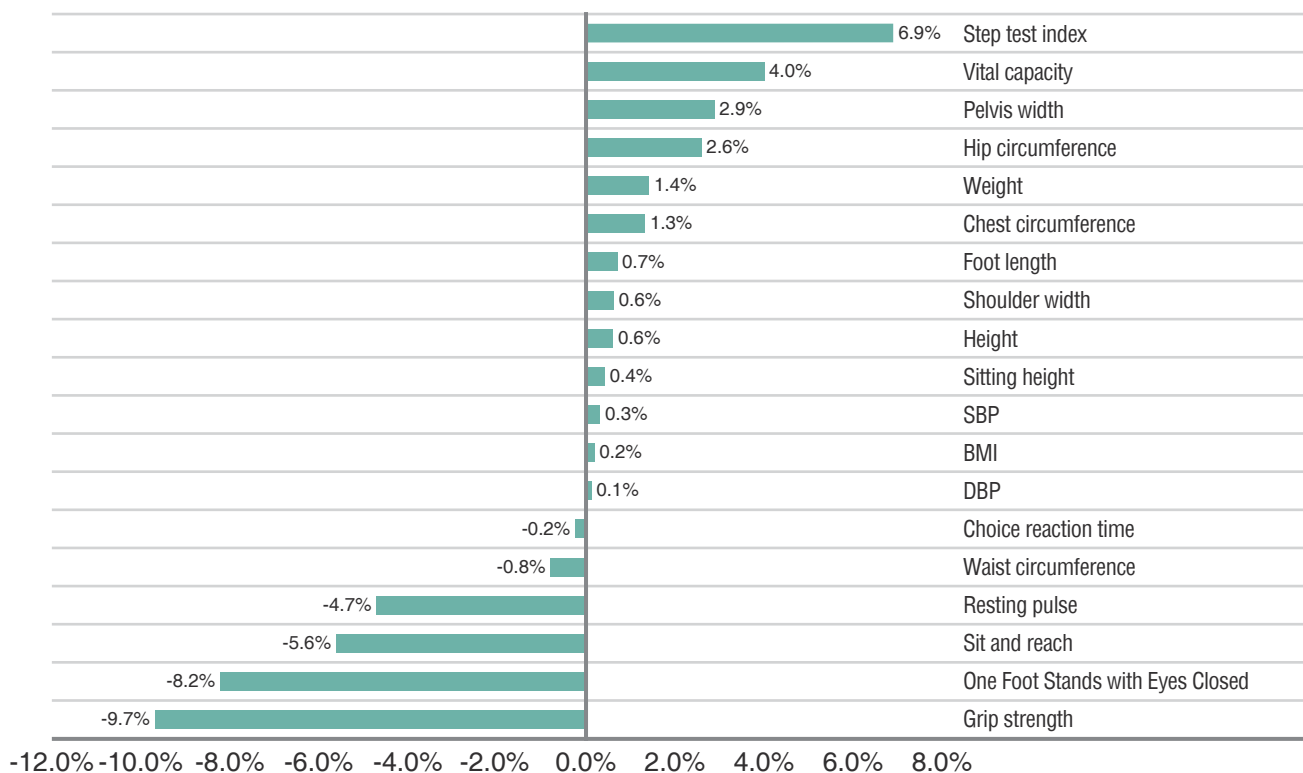

Figure 2-3-2-2 Comparison of study indicators in male adults aged 40~59

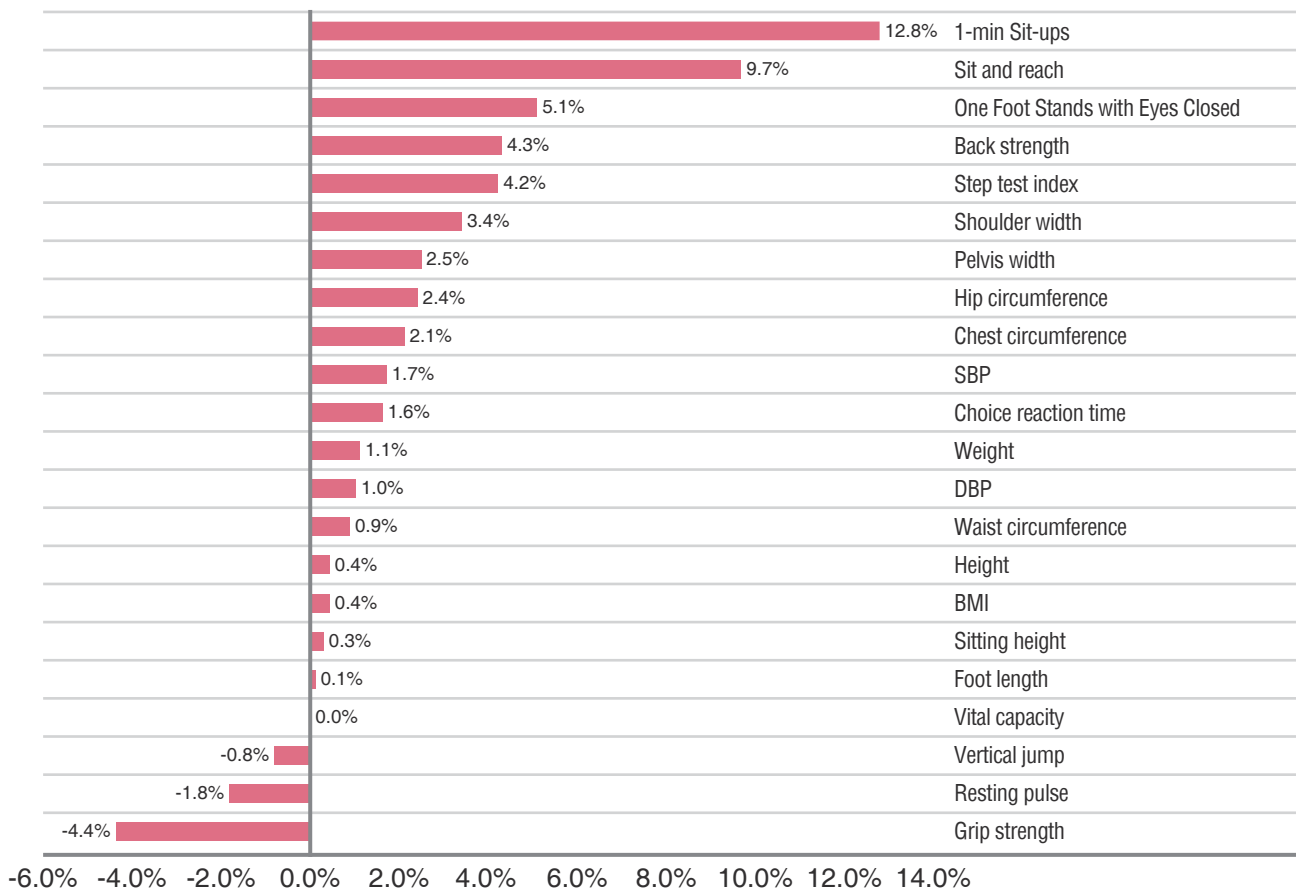

Figure 2-3-2-3 Comparison of study indicators in female adults aged 20~39

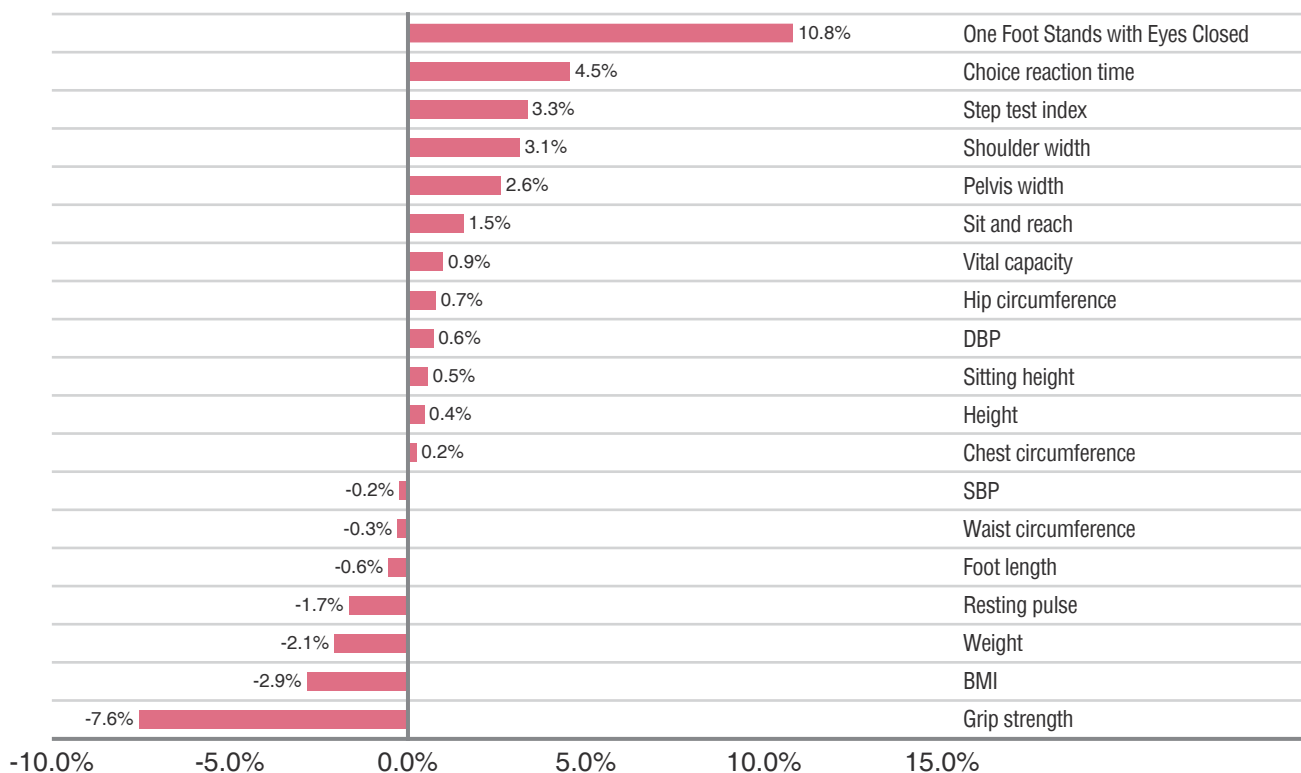

Figure 2-3-2-4 Comparison of study indicators in female adults aged 40~59

2. Comparison of Adults by Age

2.1 Comparison of Anthropometric Measurements

2.1.1 Length Indicators

Statistically significant difference was found in the average height in the aged 25~29 and 40~54 groups of males, as well as in the aged 20~24, 35~39 and 45~59 groups of females between 2015 and 2020 ($P < 0.05$), showing that the average height of adults has increased (Table 2-3-2-11).

Table 2-3-2-11 Comparison of average height in male and female adults in each age group (cm)

Age group	Male			Female		
	2020	2015	Difference	2020	2015	Difference
20~24 years	173.0	172.4	0.6	160.4	159.5	0.9*
25~29 years	173.0	172.3	0.7*	159.8	159.3	0.5
30~34 years	171.7	172.2	-0.5	159.3	158.7	0.6
35~39 years	170.4	170.2	0.2	158.8	158.1	0.7*
40~44 years	171.8	170.4	1.4*	158.5	158.1	0.4
45~49 years	169.8	168.2	1.6*	157.7	156.9	0.8*
50~54 years	169.1	168.4	0.7*	156.9	156.2	0.7*
55~59 years	167.6	167.1	0.5	156.3	155.5	0.8*

Compared with the results in 2015, obvious change was seen in the average sitting height of adults aged 20~59 in 2020, with difference found in most of the age groups. The average sitting height of males aged 20~24 and 40~59 and females aged 25~34 and 45~59 all increased with significant difference ($P < 0.05$), whereas that of males aged 30~34 decreased with significant difference ($P < 0.05$) (Table 2-3-2-12).

Table 2-3-2-12 Comparison of average sitting height in male and female adults of each age group (cm)

Age group	Male			Female		
	2020	2015	Difference	2020	2015	Difference
20~24 years	92.3	91.4	0.9*	86.7	86.5	0.2
25~29 years	92.4	92.2	0.2	86.5	86.1	0.4*
30~34 years	92.0	92.6	-0.6*	86.3	86.0	0.3*
35~39 years	91.7	91.6	0.1	86.2	86.0	0.2
40~44 years	92.2	91.9	0.3*	86.2	86.1	0.1
45~49 years	91.3	90.9	0.4*	86.0	85.6	0.4*
50~54 years	91.1	90.8	0.3*	85.3	85.0	0.3*
55~59 years	90.3	89.8	0.5*	85.0	84.1	0.9*

The average foot length was shorter in 2020 than 2015 in the aged 30~34 group of males and the aged 20~24 and 45~54 groups of females, with significant difference ($P<0.05$), and the average foot length of male adults aged 35~49 was significantly higher than that in 2015 ($P<0.05$). No statistically significant difference was observed in the remaining age groups (Table 2-3-2-13).

Table 2-3-2-13 Comparison of average foot length in male and female adults in each age group (cm)

Age group	Male			Female		
	2020	2015	Difference	2020	2015	Difference
20~24 years	25.4	25.3	0.1	22.8	23.0	-0.2*
25~29 years	25.4	25.3	0.1	22.9	22.9	0.0
30~34 years	25.1	25.3	-0.2*	22.9	22.8	0.1
35~39 years	25.1	24.9	0.2*	22.8	22.8	0.0
40~44 years	25.2	25.0	0.2*	22.8	22.9	-0.1
45~49 years	25.1	24.7	0.4*	22.7	22.9	-0.2*
50~54 years	24.9	24.8	0.1	22.7	22.9	-0.2*
55~59 years	24.6	24.6	0.0	22.8	22.8	0.0

2.1.2 Weight and BMI

Compared with the results in 2015, a significant increase was found in the weight of males aged 20~24, 55~59 and females aged 25~29, and an obvious decrease was found in the weight of females aged 45~54, with significant difference ($P<0.05$). No statistical significant difference was found in other age groups between 2015 and 2020 (Table 2-3-2-14).

Table 2-3-2-14 Comparison of average weight in male and female adults in each age group (kg)

Age group	Male			Female		
	2020	2015	Difference	2020	2015	Difference
20~24 years	67.7	65.7	2.0*	53.3	53.3	0
25~29 years	70.2	70.0	0.2	54.6	52.7	1.9*
30~34 years	69.5	70.1	-0.6	54.3	53.9	0.4
35~39 years	69.5	68.8	0.7	54.7	55.4	-0.7
40~44 years	70.6	69.4	1.2	55.9	56.8	-0.9
45~49 years	68.9	68.8	0.1	55.3	58.1	-2.8*
50~54 years	69.5	68.6	0.9	56.4	57.8	-1.4*
55~59 years	67.4	66.0	1.4*	56.0	55.7	0.3

Compared with the results in 2015, the BMI of males aged 20~24 and females aged 25~29 increased substantially in 2020, whereas the BMI of females aged 40~54 decreased, which differed significantly ($P<0.05$). No significant difference was seen in other age groups (Table 2-3-2-15).

Table 2-3-2-15 Comparison of average BMI in male and female adults of each age group

Age group	Male			Female		
	2020	2015	Difference	2020	2015	Difference
20~24 years	22.6	22.1	0.5*	20.7	20.9	-0.2
25~29 years	23.4	23.6	-0.2	21.4	20.7	0.7*
30~34 years	23.6	23.7	-0.1	21.4	21.4	0.0
35~39 years	23.9	23.7	0.2	21.7	22.1	-0.4
40~44 years	23.9	23.9	0.0	22.2	22.7	-0.5*
45~49 years	24.0	24.3	-0.3	22.2	23.6	-1.4*
50~54 years	24.3	24.2	0.1	22.9	23.7	-0.8*
55~59 years	24.0	23.6	0.4	22.9	23.1	-0.2

Based on BMI classification of underweight, normal weight, overweight and obesity, the comparison of data between 2020 and 2015 showed that: (1) for adults aged 20~39: the prevalence of overweight of males has increased by 5.6% ($P<0.05$), and the prevalence of obesity decreased by 2.5% ($P<0.05$). Although the prevalence of obesity decreased, the proportion of the overweight increased dramatically, with an increase of 3.1% in the combined overweight and obesity rate. In females, the prevalence of overweight decreased by 2.5% ($P<0.05$), and the prevalence of obesity increased by 1.1% ($P<0.05$), resulting in a decrease of 1.4% in overweight and obesity rate. The proportion of underweight females aged 20~39 in both 2015 and 2020 stayed remarkably high, accounting for 15.7% in 2020 and 18.4% in 2015, suggesting attention should be raised. (2) For adults aged 40~59: the prevalence of overweight in males decreased by 4.7% ($P<0.05$), and the prevalence of obesity increased by 1.7% ($P<0.05$), resulting in a decrease of 3.0% in overweight and obesity rate. The prevalence of overweight in females decreased by 4.6% ($P<0.05$), and the prevalence of obesity decreased by 3.5% ($P<0.05$), resulting in a decrease of 8.1% overweight and obesity rate (Tables 2-3-2-16 and 2-3-2-17).

Table 2-3-2-16 Comparison of weight status in adults aged 20~39 (%)

Gender	Year	Underweight	Normal weight	Overweight	Obesity
Male	2020	4.1	58.1	29.7	8.1
	2015	5.7	59.6	24.1	10.6
	2020-2015	-1.6*	-1.5	5.6*	-2.5*
Female	2020	15.7	68.5	10.5	5.4
	2015	18.4	64.3	13.0	4.3
	2020-2015	-2.7*	4.2*	-2.5*	1.1*

Table 2-3-2-17 Comparison of weight status in adults aged 40~59 (%)

Gender	Year	Underweight	Normal weight	Overweight	Obesity
Male	2020	1.7	55.8	32.9	9.6
	2015	1.7	52.8	37.6	7.9
	2020-2015	0.0	3.0	-4.7*	1.7*
Female	2020	5.2	66.5	23.0	5.3
	2015	4.7	58.9	27.6	8.8
	2020-2015	0.5	7.6*	-4.6*	-3.5*

2.1.3 Circumference Indicators

Compared with the results in 2015, except for an insignificant increase found in males aged 45~49, significant increase was found in chest circumference of male adults in all other age groups in 2020 ($p < 0.05$), ranging from 1.1~2.8cm. For females, except for a significant decrease in the aged 45~49 group, chest circumference increased by 0.4~2.9cm among all other age groups in 2020, which differed significantly in the aged 20~34 and 55~59 groups ($P < 0.05$) (Table 2-3-2-18).

Table 2-3-2-18 Comparison of average chest circumference in male and female adults in each age group (cm)

Age group	Male			Female		
	2020	2015	Difference	2020	2015	Difference
20~24 years	91.9	89.1	2.8*	83.2	82.0	1.2*
25~29 years	94.0	91.8	2.2*	84.5	81.6	2.9*
30~34 years	93.6	92.3	1.3*	84.4	82.7	1.7*
35~39 years	94.1	92.1	2.0*	85.1	84.6	0.5
40~44 years	94.0	92.7	1.3*	86.0	85.6	0.4
45~49 years	93.6	92.7	0.9	86.0	87.2	-1.2*
50~54 years	94.3	93.2	1.1*	87.9	87.2	0.7
55~59 years	93.3	91.9	1.4*	88.3	87.3	1.0*

Compared with the results in 2015, waist circumference of males aged 25~29 was significantly reduced in 2020 ($P < 0.05$), and slightly decreased in all other age groups with no statistical significant difference. Waist circumference of females aged 45~49 decreased significantly, whereas that of females aged 25~29 and 55~59 increased, with significant difference ($P < 0.05$). The waist circumference of females fluctuated in other age groups with no statistical significant difference (Table 2-3-2-19).

Table 2-3-2-19 Comparison of average waist circumference in male and female adults in each age group (cm)

Age group	Male			Female		
	2020	2015	Difference	2020	2015	Difference
20~24 years	78.0	78.1	-0.1	70.5	70.7	-0.2
25~29 years	80.4	82.9	-2.5*	72.7	71.2	1.5*
30~34 years	82.3	83.5	-1.2	73.6	72.8	0.8
35~39 years	83.3	83.3	0.0	75.3	75.4	-0.1
40~44 years	84.2	85.0	-0.8	77.3	76.7	0.6
45~49 years	84.7	85.3	-0.6	77.0	79.4	-2.4*
50~54 years	85.6	86.2	-0.6	79.8	80.2	-0.4
55~59 years	84.5	85.2	-0.7	81.0	79.6	1.4*

Compared with the 2015 study, the hip circumference of males increased significantly in all age groups in 2020 ($P < 0.05$), with the increase ranging from 1.5~3.0cm. In females, except for the aged 45~54 group, the hip circumference increased significantly ($P < 0.05$), with the increase ranging from 1.0~3.0cm (Table 2-3-2-20).

Table 2-3-2-20 Comparison of average hip circumference in male and female adults in each age group(cm)

Age group	Male			Female		
	2020	2015	Difference	2020	2015	Difference
20~24 years	93.7	91.6	2.1*	92.5	90.9	1.6*
25~29 years	95.1	93.4	1.7*	93.6	90.6	3.0*
30~34 years	95.0	93.5	1.5*	93.5	91.1	2.4*
35~39 years	95.4	92.9	2.5*	93.5	92.3	1.2*
40~44 years	95.6	92.6	3.0*	94.7	93.3	1.4*
45~49 years	95.0	92.4	2.6*	94.0	94.0	0.0
50~54 years	95.2	93.0	2.2*	94.4	93.9	0.5
55~59 years	93.5	91.5	2.0*	93.9	92.9	1.0*

Compared with the results in 2015, the WHR of males in the aged 20~59 groups decreased considerably in 2020 ($P < 0.05$), with the decrease ranging from 0.02~0.04. For females, the WHR remained level in the aged 40~44 and 50~59 groups, and that of females was 0.01~0.02 lower in 2020 than 2015 in all other age groups, which differed significantly ($P < 0.05$) (Table 2-3-2-21).

Table 2-3-2-21 Comparison of average WHR of adults

Age group	Male			Female		
	2020	2015	Difference	2020	2015	Difference
20~24 years	0.83	0.85	-0.02*	0.76	0.78	-0.02*
25~29 years	0.85	0.88	-0.03*	0.78	0.79	-0.01*
30~34 years	0.87	0.89	-0.02*	0.79	0.80	-0.01*
35~39 years	0.87	0.90	-0.03*	0.81	0.82	-0.01*
40~44 years	0.88	0.92	-0.04*	0.82	0.82	0.0
45~49 years	0.89	0.92	-0.03*	0.82	0.84	-0.02*
50~54 years	0.90	0.93	-0.03*	0.85	0.85	0.0
55~59 years	0.90	0.93	-0.03*	0.86	0.86	0.0

2.1.4 Width Indicators

Compared with the results in 2015, the average shoulder and pelvis width of female adults increased significantly ($P < 0.05$) in 2020, ranging from 0.8~1.5cm for shoulder width and 0.6~0.8cm for pelvis width. The average shoulder width of male adults aged 30~39 significantly decreased ($P < 0.05$), and that of male adults aged 25~29 and 45~59 dramatically increased ($P < 0.05$). Except for the 25~29 year age group, the pelvis width of males significantly increased in all other age groups ($P < 0.05$), with the increase ranging from 0.6~1.1cm (Tables 2-3-2-22 and 2-3-2-23).

Table 2-3-2-22 Comparison of average shoulder width in male and female adults in each age group (cm)

Age group	Male			Female		
	2020	2015	Difference	2020	2015	Difference
20~24 years	39.4	39.6	-0.2	35.1	33.6	1.5*
25~29 years	40.1	39.6	0.5*	35.3	33.9	1.4*
30~34 years	39.7	40.1	-0.4*	35.1	34.1	1.0*
35~39 years	39.4	39.7	-0.3*	35.2	34.2	1.0*
40~44 years	39.7	39.5	0.2	35.5	34.4	1.1*
45~49 years	39.5	39.2	0.3*	35.4	34.3	1.1*
50~54 years	39.3	39.0	0.3*	35.1	34.3	0.8*
55~59 years	38.9	38.6	0.3*	35.3	34.0	1.3*

Table 2-3-2-23 Comparison of average pelvis width in male and female adults in each age group (cm)

Age group	Male			Female		
	2020	2015	Difference	2020	2015	Difference
20~24 years	28.2	27.2	1.0*	27.2	26.6	0.6*
25~29 years	28.2	28.0	0.2	27.5	26.9	0.6*
30~34 years	28.6	28.0	0.6*	27.7	27.0	0.7*
35~39 years	28.7	27.7	1.0*	28.0	27.3	0.7*
40~44 years	28.9	27.8	1.1*	28.3	27.5	0.8*
45~49 years	28.5	27.8	0.7*	28.4	27.7	0.7*
50~54 years	28.7	27.9	0.8*	28.5	27.8	0.7*
55~59 years	28.7	28.0	0.7*	28.7	28.0	0.7*

2.1.5 Body Composition

In 2020, body fat percentage was directly measured using bioelectrical impedance analysis. While in 2015, body fat percentage was derived from the computed formula after the measurement of skinfold thickness. Therefore, the average values in the two studies cannot be compared in principle. The comparison results shown below were for reference only, which showed that the body fat percentage of male adults was higher in 2020 than 2015 in most age groups ($P < 0.05$), and that of females decreased significantly between aged 35~49 but increased substantially between aged 55~59 ($P < 0.05$) (Table 2-3-2-24).

Table 2-3-2-24 Comparison of average body fat percentage in male and female adults in each age group (%)

Age group	Male			Female		
	2020	2015	Difference	2020	2015	Difference
20~24 years	19.3	16.7	2.6*	24.0	24.3	-0.3
25~29 years	21.0	19.6	1.4*	25.3	25.2	0.1
30~34 years	21.6	19.7	1.9*	26.0	26.1	-0.1
35~39 years	22.0	19.0	3.0*	26.8	28.1	-1.3*
40~44 years	22.2	19.8	2.4*	28.2	30.1	-1.9*
45~49 years	21.8	19.7	2.1*	28.7	30.8	-2.1*
50~54 years	22.8	19.7	3.1*	30.3	30.8	-0.5
55~59 years	22.1	17.5	4.6*	30.4	28.3	2.1*

In terms of lean body mass, the lean body mass of males decreased in all age groups in 2020 compared with that in 2015, among which the lean body mass of males aged 30~39 and 45~59 decreased significantly ($P < 0.05$). Compared with the results in 2015, the lean body mass of females was significantly higher in 2020 in the aged 25~29 group, but significantly lower in the aged 55~59 group ($P < 0.05$). No statistically significant difference was found in other age groups of females (Table 2-3-2-25).

Table 2-3-2-25 Comparison of average lean body mass in male and female adults in each age group (kg)

Age group	Male			Female		
	2020	2015	Difference	2020	2015	Difference
20~24 years	54.1	54.4	-0.3	40.0	40.1	-0.1
25~29 years	54.9	55.7	-0.8	40.2	38.9	1.3*
30~34 years	53.9	55.7	-1.8*	39.8	39.4	0.4
35~39 years	53.7	55.2	-1.5*	39.6	39.4	0.2
40~44 years	54.5	55.4	-0.9	39.8	39.2	0.6
45~49 years	53.5	54.9	-1.4*	39.1	39.7	-0.6
50~54 years	53.3	54.7	-1.4*	39.0	39.4	-0.4
55~59 years	52.2	53.9	-1.7*	38.6	39.7	-1.1*

2.2 Comparison of Physiological Function

2.2.1 Resting Pulse

Compared with the results in 2015, the resting pulse exhibited a significantly decreasing trend in 2020 in the 20~34, 40~44 and 50~59 year age groups of males and the 30~54 year age groups of females ($P < 0.05$). The difference was relatively small in other age groups (Table 2-3-2-26).

Table 2-3-2-26 Comparison of average resting pulse in male and female adults in each age group (bpm)

Age group	Male			Female		
	2020	2015	Difference	2020	2015	Difference
20~24 years	72.9	74.5	-1.6*	78.7	77.5	1.2
25~29 years	71.6	75.8	-4.2*	77.2	77.7	-0.5
30~34 years	72.2	76.7	-4.5*	75.8	78.8	-3.0*
35~39 years	72.6	73.7	-1.1	76.0	78.1	-2.1*
40~44 years	69.9	75.0	-5.1*	74.6	77.5	-2.9*
45~49 years	71.8	73.1	-1.3	74.6	76.2	-1.6*
50~54 years	71.5	74.5	-3.0*	71.6	75.3	-3.7*
55~59 years	69.2	73.7	-4.5*	73.0	72.3	0.7

2.2.2 Blood Pressure

Compared with the results in 2015, the SBP of male adults generally decreased in 2020, with a significant decline in the 25~34 year age group ($P < 0.05$), and a significant increase in the 50~54 year age group ($P < 0.05$). The DBP of male adults decreased dramatically in the 25~34 and 55~59 year age groups ($P < 0.05$), and increased significantly in the 50~54 year age group ($P < 0.05$). For females, their SBP increased significantly in the 25~34 year age groups ($P < 0.05$), and decreased significantly in the 50~54 year age group ($P < 0.05$). The

DBP of female adults increased substantially in the 25~34 and 55~59 year age groups ($P < 0.05$). No significant difference was found in pressure difference in each age group (Tables 2-3-2-27, 2-3-2-28, and 2-3-2-29).

Table 2-3-2-27 Comparison of average SBP in male and female adults in each age group (mmHg)

Age group	Male			Female		
	2020	2015	Difference	2020	2015	Difference
20~24 years	126.5	126.5	0.0	110.8	110.6	0.2
25~29 years	126.0	127.5	-1.5*	111.2	107.4	3.8*
30~34 years	126.6	128.7	-2.1*	110.3	108.8	1.5*
35~39 years	126.2	126.3	-0.1	112.5	111.7	0.8
40~44 years	127.9	128.2	-0.3	115.0	114.8	0.2
45~49 years	128.3	128.3	0.0	118.2	118.4	-0.2
50~54 years	133.2	130.5	2.7*	121.6	123.9	-2.3*
55~59 years	131.0	131.7	-0.7	126.4	125.2	1.2

Table 2-3-2-28 Comparison of average DBP in male and female adults in each age group (mmHg)

Age group	Male			Female		
	2020	2015	Difference	2020	2015	Difference
20~24 years	72.6	73.1	-0.5	69.1	68.8	0.3
25~29 years	72.4	74.9	-2.5*	68.9	67.3	1.6*
30~34 years	74.4	76.9	-2.5*	68.8	67.9	0.9*
35~39 years	75.6	75.8	-0.2	68.8	69.5	-0.7
40~44 years	76.9	76.6	0.3	70.1	70.4	-0.3
45~49 years	76.9	77.3	-0.4	71.1	70.4	0.7
50~54 years	80.1	78.7	1.4*	72.4	73.2	-0.8
55~59 years	77.7	78.8	-1.1*	73.2	71.3	1.9*

Table 2-3-2-29 Comparison of average pressure difference in male and female adults in each age group (mmHg)

Age group	Male			Female		
	2020	2015	Difference	2020	2015	Difference
20~24 years	53.9	53.4	0.5	41.7	41.9	-0.2
25~29 years	53.6	52.6	1.0	42.4	40.1	2.3
30~34 years	52.0	51.9	0.1	41.6	40.9	0.7
35~39 years	50.6	50.4	0.2	43.7	42.3	1.4
40~44 years	51.2	51.6	-0.4	45.0	44.3	0.7
45~49 years	51.5	51.0	0.5	47.2	48.0	-0.8
50~54 years	53.3	51.8	1.5	49.3	50.8	-1.5
55~59 years	53.3	52.9	0.4	53.2	54.0	-0.8

2.2.3 Vital Capacity and Vital Capacity/Weight

Compared with the results in 2015, the vital capacity of male adults decreased significantly in the 30~34 year age group in 2020 ($P<0.05$), but increased significantly in the 45~49 and 55~59 year age groups ($P<0.05$). The vital capacity of female adults showed an upward trend, except for a significant decrease in the 20~24 year age group ($P<0.05$), and increase was observed in most of the remaining age groups but without significant difference. The vital capacity/weight of male and female adults varied mildly in 2020 (Tables 2-3-2-30 and 2-3-2-31).

Table 2-3-2-30 Comparison of average vital capacity in male and female adults in each age group (ml)

Age group	Male			Female		
	2020	2015	Difference	2020	2015	Difference
20~24 years	4058.1	4033.6	24.5	2668.6	2789.7	-121.1*
25~29 years	4020.7	4038.9	-18.2	2762.1	2737.0	25.1
30~34 years	3865.0	4064.0	-199.0*	2773.8	2749.1	24.7
35~39 years	3835.1	3867.7	-32.6	2692.3	2686.9	5.4
40~44 years	3785.2	3795.5	-10.3	2542.0	2562.6	-20.6
45~49 years	3669.8	3475.7	194.1*	2449.4	2408.1	41.3
50~54 years	3544.4	3485.5	58.9	2362.9	2322.6	40.3
55~59 years	3423.8	3144.7	279.1*	2225.0	2213.6	11.4

Table 2-3-2-31 Comparison of average vital capacity/weight in male and female adults in each age group (ml/kg)

Age group	Male			Female		
	2020	2015	Difference	2020	2015	Difference
20~24 years	60.7	61.9	-1.2	50.8	53.0	-2.2*
25~29 years	58.1	58.9	-0.8	51.4	52.5	-1.1
30~34 years	56.5	59.1	-2.6*	51.9	51.9	0.0
35~39 years	56.0	57.1	-1.1	49.9	49.3	0.6
40~44 years	54.3	55.3	-1.0	46.2	45.9	0.3
45~49 years	54.1	51.2	2.9*	45.0	42.0	3.0*
50~54 years	51.8	51.6	0.2	42.6	41.3	1.3
55~59 years	51.4	48.2	3.2*	40.7	40.3	0.4

2.2.4 Step Test Index

Compared with the results in 2015, the step test index of adults had increased significantly in the past five years. In male adults, the step test index has increased significantly in all age groups ($P < 0.05$) except for the aged 20~24 group with no statistical significance. The step test index of females also increased substantially in the aged 20~44 and 50~54 groups ($P < 0.05$) (Table 2-3-2-32).

Table 2-3-2-32 Comparison of average step test index in male and female adults in each age group

Age group	Male			Female		
	2020	2015	Difference	2020	2015	Difference
20~24 years	56.1	56.2	-0.1	56.4	54.4	2.0*
25~29 years	56.5	53.3	3.2*	57.6	55.1	2.5*
30~34 years	56.7	53.2	3.5*	58.5	55.7	2.8*
35~39 years	58.0	56.2	1.8*	58.2	56.5	1.7*
40~44 years	59.1	55.8	3.3*	60.7	57.1	3.6*
45~49 years	59.4	55.8	3.6*	59.8	58.7	1.1
50~54 years	59.7	56.2	3.5*	60.8	57.6	3.2*
55~59 years	61.5	56.4	5.1*	60.4	60.2	0.2

2.3 Comparison of Physical Fitness

2.3.1 Strength

Compared with the results in 2015, the vertical jump of males in 2020 declined significantly in the 30~34 year age group ($P < 0.05$) and varied little in all other age groups. The vertical jump of females decreased slightly without statistical significance (Table 2-3-2-33).

Compared with the results in 2015, push-ups of males and one-minute sit-ups of females has increased in 2020, which differed significantly in the aged 25~29 group for males and in all age groups for females ($P < 0.05$). Back strength increased substantially in the aged 25~29 group for males and aged 25~34 groups for females ($P < 0.05$), while it varied in all other age groups without statistical significance. Grip strength of males and females decreased significantly in all age groups ($P < 0.05$) except for the aged 25~29 group for females with little change (Tables 2-3-2-34, 2-3-2-35 and 2-3-2-36).

Table 2-3-2-33 Comparison of average vertical jump in male and female adults in each age group (cm)

Age group	Male			Female		
	2020	2015	Difference	2020	2015	Difference
20~24 years	38.6	37.7	0.9	24.7	25.0	-0.3
25~29 years	37.4	36.8	0.6	23.7	24.0	-0.3
30~34 years	35.6	37.3	-1.7*	23.3	23.7	-0.4
35~39 years	34.6	35.5	-0.9	23.2	22.9	0.3

Table 2-3-2-34 Comparison of average push-ups (male) and one-minute sit-ups (female) in adults in each age group (times)

Age group	Male			Female		
	2020	2015	Difference	2020	2015	Difference
20~24 years	31.3	30.2	1.1	26.6	24.8	1.8*
25~29 years	31.7	26.6	5.1*	25.6	22.6	3.0*
30~34 years	28.3	27.2	1.1	23.6	21.2	2.4*
35~39 years	26.4	26.1	0.3	22.5	19.2	3.3*

Table 2-3-2-35 Comparison of average back strength in male and female adults in each age group (kg)

Age group	Male			Female		
	2020	2015	Difference	2020	2015	Difference
20~24 years	111.2	110.4	0.8	59.4	61.4	-2.0
25~29 years	118.2	108.6	9.6*	60.4	55.3	5.1*
30~34 years	110.6	108.4	2.2	61.2	58.2	3.0*
35~39 years	106.8	108.1	-1.3	58.3	57.6	0.7

Table 2-3-2-36 Comparison of average grip strength in male and female adults in each age group (kg)

Age group	Male			Female		
	2020	2015	Difference	2020	2015	Difference
20~24 years	40.4	42.9	-2.5*	23.8	25.7	-1.9*
25~29 years	41.2	43.9	-2.7*	24.1	24.1	0.0
30~34 years	40.8	45.0	-4.2*	23.6	24.9	-1.3*
35~39 years	40.1	44.7	-4.6*	23.8	25.6	-1.8*
40~44 years	41.4	46.0	-4.6*	23.8	26.4	-2.6*
45~49 years	40.5	45.1	-4.6*	23.4	25.7	-2.3*
50~54 years	39.6	45.1	-5.5*	22.7	24.4	-1.7*
55~59 years	38.6	41.2	-2.6*	22.1	23.4	-1.3*

2.3.2 Flexibility

Compared with the results in 2015, sit and reach in males decreased significantly in the aged 35~54 groups ($P < 0.05$), and increased significantly in the aged 55~59 group ($P < 0.05$). For females, sit and reach increased significantly in the aged 20~39 groups ($P < 0.05$), and varied mildly in all other age groups (Table 2-3-2-37).

Table 2-3-2-37 Comparison of average sit and reach in male and female adults in each age group (cm)

Age group	Male			Female		
	2020	2015	Difference	2020	2015	Difference
20~24 years	2.9	2.1	0.8	8.9	7.0	1.9*
25~29 years	2.6	2.4	0.2	9.6	5.2	4.4*
30~34 years	1.4	2.4	-1.0	7.9	6.2	1.7*
35~39 years	1.3	2.7	-1.4*	7.0	5.5	1.5*
40~44 years	0.6	2.6	-2.0*	6.2	7.3	-1.1
45~49 years	-0.4	1.7	-2.1*	6.9	5.9	1.0
50~54 years	-0.6	2.1	-2.7*	6.6	6.1	0.5
55~59 years	0.9	-0.6	1.5*	7.5	6.7	0.8

2.3.3 Reaction

Compared with the results in 2015, the reaction of males aged 25~29 has improved significantly ($P < 0.05$), and no obvious changes was found in other age groups. For females, the reaction increased substantially in the aged 40~59 groups ($P < 0.05$), and no significant change was seen in other age groups (Table 2-3-2-38).

Table 2-3-2-38 Comparison of average choice reaction time in male and female adults in each age group (sec)

Age group	Male			Female		
	2020	2015	Difference	2020	2015	Difference
20~24 years	0.39	0.40	-0.01	0.44	0.43	0.01
25~29 years	0.39	0.41	-0.02*	0.44	0.45	-0.01
30~34 years	0.41	0.41	0.0	0.45	0.45	0.0
35~39 years	0.42	0.43	-0.01	0.45	0.46	-0.01
40~44 years	0.42	0.43	-0.01	0.46	0.48	-0.02*
45~49 years	0.43	0.44	-0.01	0.47	0.50	-0.03*
50~54 years	0.45	0.44	0.01	0.49	0.51	-0.02*
55~59 years	0.46	0.45	0.01	0.50	0.52	-0.02*

2.3.4 Balance

Compared with the results in 2015, balance of male adults generally has varied mildly in 2020, and has substantially increased in the aged 25~29 and 45~49 groups ($P < 0.05$), but decreased significantly in the aged 40~44 and 55~59 groups ($P < 0.05$). For female adults, their balance has considerably improved in the aged 30~39 and 50~54 groups in 2020 ($P < 0.05$), and relatively small changes without statistical significance was observed in other age groups (Table 2-3-2-39).

Table 2-3-2-39 Comparison of average OFSEC time in male and female adults in each age group (sec)

Age group	Male			Female		
	2020	2015	Difference	2020	2015	Difference
20~24 years	44.8	47.9	-3.1	44.5	45.2	-0.7
25~29 years	44.8	39.4	5.4*	43.8	46.3	-2.5
30~34 years	38.7	36.6	2.1	44.9	39.6	5.3*
35~39 years	37.9	40.4	-2.5	37.1	33.5	3.6*
40~44 years	27.2	30.6	-3.4*	32.0	30.7	1.3
45~49 years	30.3	26.5	3.8*	27.0	25.9	1.1
50~54 years	20.2	22.6	-2.4	22.9	18.4	4.5*
55~59 years	17.5	22.7	-5.2*	17.8	14.1	3.7

(III) Summary

1. Summary of 2020 Results on Physical Fitness Study of Adults

1.1 Living Habits and Physical Exercise

In terms of major transportation means of adult subjects in 2020, the proportion of males and females aged 20~39 who commute via walking or bicycling accounted for 19.3% and 28.1% respectively, while that of males and females aged 40~59 accounted for 23.3% and 39.2%, respectively. The others mainly commuted with transportation means that are motorized. Our study showed that females who walk or ride the bicycle was significantly higher than males, but Macao adults who commute with transportation means that are non-motorized (walking or bicycling) accounted for a relatively small proportion.

In terms of sleeping time in 2020, male and female adults aged 20~39 who sleep less than 6 hours (exclusive) daily accounted for 3.5% and 4.3%, respectively. Male and female adults aged 40~59 who sleep less than 6 hours (exclusive) daily accounted for 2.8% and 7.0%. It was indicated that Macao adults had sufficient sleeping time.

In terms of frequency (times per week) of physical exercise in 2020, the proportion of male and female adults aged 20~39 who exercise 3 times or more per week accounted for 49.9% and 32.9% respectively, and those who exercise once or less per week accounted for 19.2% and 31.4%, respectively. Among adults aged 40~59, 53.6% of males and 51.9% of females exercise 3 times or more per week; and 16.5% of males and 17.4% of females exercise once or less per week. Therefore, the proportion of adults aged 20~39 who exercise every week was far lower than that of adults aged 40~59.

In terms of exercise duration in each session, among adult subjects who exercise in 2020, the proportion of males and females aged 20~39 who exercise for 30 minutes or more each time accounted for 82.4% and 73.5% respectively, and males and females aged 40~59 accounted for 78.8% and 79.3%, respectively. Therefore, the proportion of males aged 20~39 who exercise for 30 minutes or more was 3.6% higher than that of males aged 40~59, while the proportion of females aged 20~39 who exercise for 30 minutes or more was 5.8% lower than that of females aged 40~59.

In terms of intensity of each exercise, the proportion of male adults who exercise at high exercise intensity peaked at 69.0% in the 30~34 year age group, while female adults peaked at 47.0% in the 40~44 year age group. In comparison among genders, the proportion of Macao males across all age groups who exercise at high exercise intensity is higher than females of the same age group.

According to types of physical exercises adult subjects participate frequently, the top six types of exercises for male adults in descending order were running, walking, swimming, playing badminton, riding the bicycle and strength training. The top six for female adults in descending order were walking, running, yoga or Pilates, swimming, playing badminton and riding the bicycle. The major reasons for both male and female adults who chose the above exercises in descending order were: random choices, convenient to practice, and making choice paralleled with their families/friends/colleagues. The major obstacles that hindered adults to engage in physical exercise for males in descending order were as follows: busy work, lack of venues, burden of house chores, lack of venues nearby, lack of coaching advice and concern of injuries. For females, obstacles in descending order were: busy work, lack of venues nearby, burden of house chores, lack of coaching advice, lack of venues and lack of interest.

1.2 Anthropometric Measurements

The length and width indicators of Macao adults were have basically developed between ages 20~24. The length indicators of adults aged 20~59 showed a decreasing trend with with advancing age between ages 20~59, while their width indicators remained almost constant. As age increased, weight increased gradually in males aged 20~29 and females before age 55, afterwards it remained stable or slightly decreased. For males, chest circumference before age 29, and waist circumference before age 55 increased in trend with advancing age, then remained level. For females, chest and waist circumferences increased with advancing age before age 55. In addition, waist circumference of both males and females increased at a rate faster than hip circumference. In terms of body fat percentage, adult obesity rate (especially abdominal obesity) in Macao increased with age, and only remained steady or mildly decreased in males and females aged 55 onwards.

1.3 Physiological Function

Among adults aged 20~59, their blood pressure increased gradually with advancing age, while their vital capacity decreased significantly with age. Besides, the step test index of males increased with advancing age, while that of females increased between aged 20~44 and remained stable between aged 45~59.

1.4 Physical Fitness

The grip and back strength of adults aged 20~59 varied slightly with advancing age, and remained at its highest for a fairly long period. However, their explosive force, strength endurance, reaction ability and balance ability decreased rather rapidly with advancing age. By contrast, females had better flexibility than males and their balance ability was comparable to that of males. Other physical fitness indicators suggested males were generally better than females.

2. Comparison of 2020 and 2015 Physical Fitness Study Results of Adults

In 2020, the proportion of males aged 20~59 who sleep less than 6 hours (exclusive) decreased from 13.1% in 2015 to 3.2% in 2020, and that of females decreased from 16.4% in 2015 to 5.4% in 2020. In other words, the proportion of males and females who have an average sleeping time of more than 6 hours in 2020 has increased by 9.9% and 11% respectively when compared with the results in 2015.

In 2020, 36.1% of adult subjects aged 20~59 were frequent exercisers, which increased by 20.1% from

16.0% in 2015.

Compared with the anthropometric indicators in 2015, the height and sitting height of males and females increased slightly in most age groups in 2020. Weight of males in general has increased, while the weight of females increased between aged 20~34 but decreased after age 35. Shoulder width and pelvis width of adults increased mildly in most age groups. Waist circumference of males decreased in all age groups, while that of females showed no obvious pattern. Chest and hip circumferences increased in both genders. For adults aged 20~39: the prevalence of overweight in males has increased by 5.6%, and obesity rate decreased by 2.5%. Although the prevalence of obesity decreased, the rate of overweight has increased dramatically, which resulted an increase of 3.1% when combined. The prevalence of overweight of females has decreased by 2.5%, and the prevalence of obesity increased by 1.1%, which resulted a decrease of 1.4% when combined. The proportion of underweight in females aged 20~39 in both 2015 and 2020 remained remarkably high, accounting for 15.7% in 2020 and 18.4% in 2015, thus attention should be raised. For adults aged 40~59: the prevalence of overweight in males has decreased by 4.7%, and the prevalence of obesity increased by 1.7%, resulted a decrease of 3.0% when combined, the prevalence of overweight in females has decreased by 4.6%, and the prevalence of obesity decreased by 3.5%, resulted a decrease of 8.1% when combined.

When comparing with the physiological function indicators in 2015, the vital capacity of male adults has decreased in aged 25~44 but increased in other age groups. Vital capacity of females has increased in the majority of age groups, with no statistically significant difference observed. Blood pressure remained fairly stable without significant changes in trend. Step test index has increased in most age groups with statistically significant difference observed.

When comparing with the physical fitness indicators in 2015, the indicators of grip strength in Macao adults has decreased considerably with statistical significance. Strength endurance has increased with statistical significance; back strength has increased, whereas vertical jump has slightly decreased, as for the One Foot Stands with Eyes Closed time, there was significant changes found in males, but females in general has improved statistically significant difference. Flexibility of males has generally declined with statistically significant difference, and that of females has increased overall with statistically significant difference. Choice reaction time among both males and females have improved with statistical significance observed in females.

IV. Seniors

(I) Physical Fitness Conditions of Seniors in 2020

1. Basic Information of the Subjects

Subjects were divided into two categories by gender and further classified into eight age groups which differed by five years, i.e. 60~64, 65~69, 70~74 and 75~79. There were a total of 1,074 valid subjects, comprising 358 males and 716 females. The sample size of senior subjects in each age group was shown in Table 2-4-1-1.

A total of 505 subjects (194 males and 311 females) comprised of 65 subjects aged 60 or over drawn from Macao public or private institutions and communities, as well as 440 other individuals. Besides, 155 subjects (20 males and 135 females) were randomly drawn from senior agencies in the northern area (Nossa Senhora de Fátima), including Community Organizations of União Geral das Associações dos Moradores de Macau (General Union of Neighbourhood Associations of Macau), Centro de Convívio da Associação de Mútuo Auxílio dos Moradores de Mong-Há, Centro de Convívio da Obra das Mães, Centro de Actividades para Idosos de “Tung Sin Tong” (Macao Tung Sin Tong Charitable Society Senior Activity Center) and Service Centers of Federação das Associações dos Operários de Macau (Macao Federation of Trade Unions). 53 subjects (6 males and 47 females) were picked from Centro das Idosas da Associação Geral das Mulheres de Macau (The Women’s Association of Macau) and Centro de Dia “Chong Pak Chi Ká” in the central area (Santo António and São Lázaro). 361 subjects (138 males and 223 females) were from senior agencies in the southern and island area (Nossa Senhora do Carmo, São Lourenço and Sé Catedral), including Centro de Convívio da Associação dos Habitantes das Ilhas Kuan Iek, Macao Polytechnic Institute – Seniors Academy, Service Centers of Associação Geral das Mulheres de Macau (The Women’s Association of Macau), Casa dos “Pinheiros” da Taipa and Centro Diurno Prazer para Idosos da Associação Geral das Mulheres de Macau (The Women’s Association of Macau) (Table 3-4-1-1). Residential distribution of the subjects in the senior agencies was shown in Table 3-4-1-2.

Table 2-4-1-1 Sample size of senior subjects in each age group

Age group	60-64 years	65-69 years	70-74 years	75-79 years	Subtotal
Male	97	81	95	85	358
Female	252	217	146	101	716
Total	349	298	241	186	1074

In terms of birthplace, 58.0% of senior subjects (59.2% of males and 57.4% of females) were born in Mainland China, while 33.7% (33.2% of males and 33.9% of females) were born in Macao (Table 3-4-1-3).

In terms of education level, senior subjects who had elementary education (primary school or below) accounted for 37.8% for males and 47.7% for females, those with secondary education (secondary school or post-secondary education) accounted for the highest proportion, with 60.6% of males and 51.2% of females (Table 3-4-1-4). Generally, males had a higher education level than females, with significant gender difference observed in those with primary school level or below and secondary school level ($P < 0.05$).

In terms of labor intensity of daily work, the proportion of senior subjects who engaged in sedentary activities, activities done seated with upper limb movements, and heavy physical activities accounted for 50.2%, 42.7% and 5.3% in males and 45.5%, 53.2% and 1.3% in females, respectively, with significant gender difference found ($P < 0.05$) (Table 3-4-1-5).

In terms of occupations, the proportion of senior subjects' current or pre-retirement occupation as customer service, sales representative and similar work nature was the highest, with 31.6% of males and 21.4% of females, followed by 15.9% of males as handicraft workers and artisans, and 16.5% of females as office clerks (Table 3-4-1-6).

According to their current work status, the majority of senior subjects had already retired. Only 21.5% of males and 16.1% of females still had regular work, among which subjects who normally work five days a week contributed to the highest proportion, 42.9% for males and 45.2% for females. Most of them worked 5~9 hours per day, accounting for 74.0% for males and 62.6% for females (Tables 3-4-1-7, 3-4-1-8, 3-4-1-9).

2. Lifestyle

Five areas including living habits, physical exercise, occurrence of diseases, perception of the physical fitness study and fitness literacy were examined in senior subjects aged 60~79.

2.1 Living Habits

In terms of sleeping time, in 2020, male and female seniors aged 60~79 sleep an average of 7.5 hours and 6.8 hours, respectively. 4.7% of males and 15.5% of females sleep less than 6 hours,; 77.4% of males and 78.5% of females sleep 6~9 hours, and those with an average of 9 hours of sleep or more accounted for 17.9% and 6.0% in males and females, respectively (Figure 2-4-1-1 and Table 3-4-2-1).

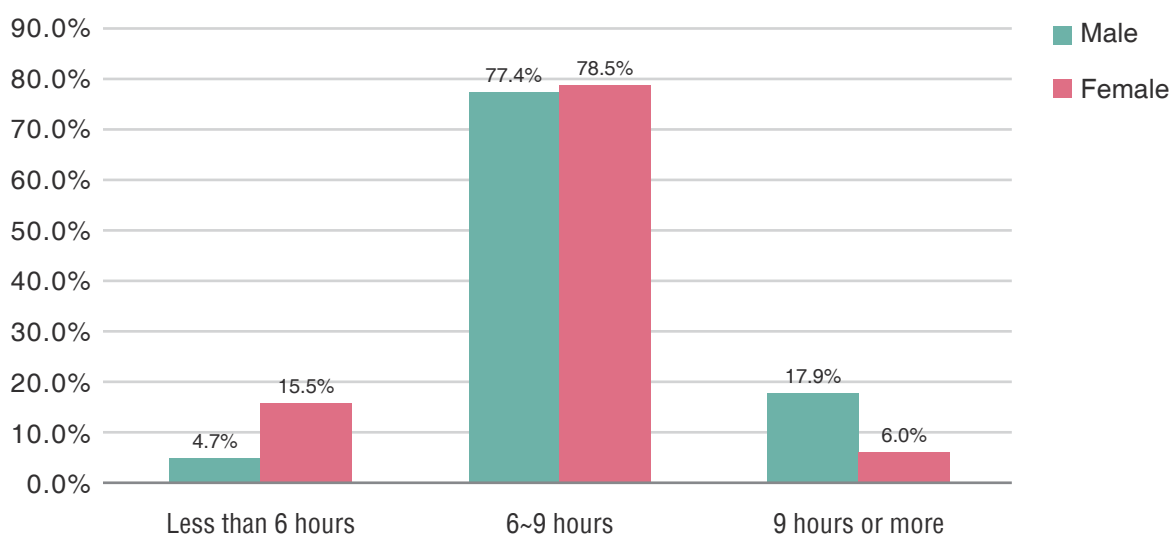

Figure 2-4-1-1 Proportion of male and female seniors with different sleeping time

In terms of transportation means, the proportion of male and female seniors that used non-motorized transportation means (such as walking or bicycling) accounted for 44.7% and 55.9%, respectively. The proportion of males and females who ride the motorcycle accounted for 9.8% and 2.9%, respectively, and 5.3% of males and 2.7% of females drive. Those who used public transport, private car or motorcycle accounted for 40.2% in males and 38.4% in females. Significant difference was observed between genders in all transportation means except for the use of public transport, private car or motorcycle ($P < 0.05$) (Table 3-4-2-2).

Based on subjects who walk or ride the bicycle for at least 10 minutes in duration, the highest proportion was recorded in those who do so for 6~7 days per week, followed by 3~5 days per week, with the lowest proportion in 0~2 days per week. In particular, 58.9% males and 64.5% females walk or bicycle 6~7 days per week, which showed that Macao seniors bicycle on most days of the week (Table 3-4-2-3). As for the average daily walking

or bicycling time of seniors, a higher proportion is observed in those who spend 1~2 hours, followed by 30~60 minutes (Figure 2-4-1-2, Table 3-4-2-4).

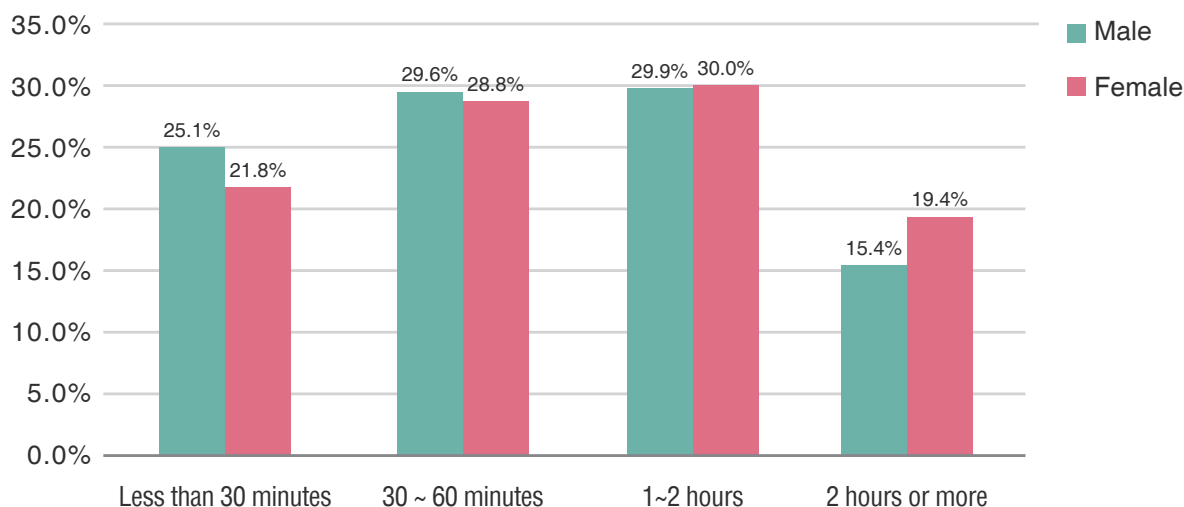

Figure 2-4-1-2 Proportion of average daily accumulated walking or bicycling time of male and female seniors

In terms of sitting time in 2020, the proportion of seniors who sit for an average of 3~6 hours daily was highest, accounting for 46.9% of males and 48.0% of females; followed by 6~9 hours, accounting for 31.5% of males and 29.9% of females. The difference between genders was found significant in those with an average daily accumulated sitting time of 9~12 hours ($P < 0.05$) (Figure 2-4-1-3, Table 3-4-2-5).

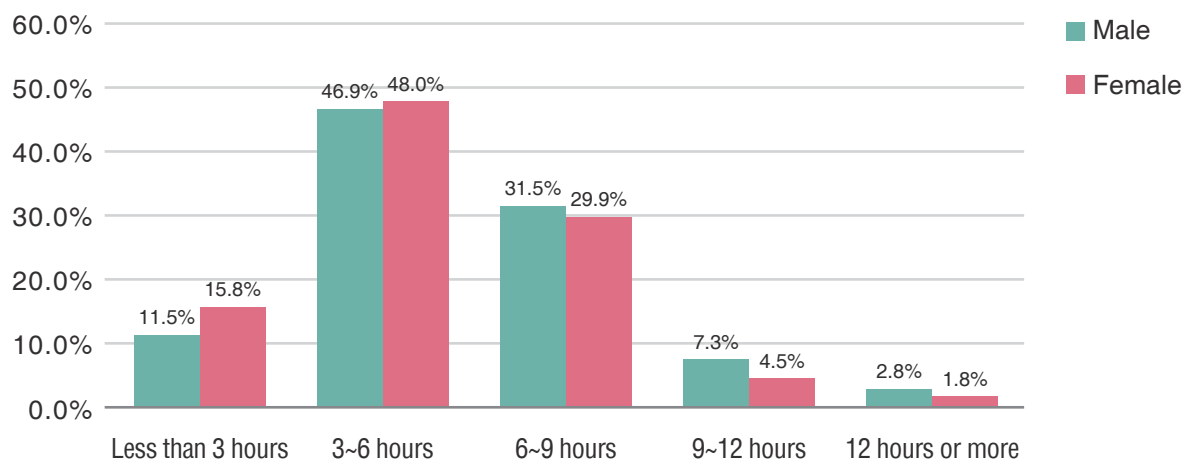

Figure 2-4-1-3 Proportion of average daily accumulated sitting time of male and female seniors

In terms of leisure-time activities, the top three leisure-time activities for seniors in 2020 were watching TV, using computer/mobile phone/game console, and doing house chores, which accounted for 73.8%, 34.7% and 34.2%, respectively. Specifically, subjects who preferred watching TV accounted for 76.8% in males and 72.3% in females. Those who chose computer/mobile phone/game console accounted for 28.8% in males and 37.7% in females, and 20.1% of males and 41.2% of females chose house chores. Significant gender difference was observed in the latter two activities ($P < 0.05$) (Table 3-4-2-6).

2.2 Physical Exercise

In terms of exercise frequency, the proportion of male and female seniors who exercise seven times or more per week was the highest, accounting for 41.9% in males and 35.6% in females, followed by five times per week in males and four times per week in females. Significant gender difference was seen in those who exercise seven times or more per week and four times per week ($P < 0.05$) (Figure 2-4-1-4 and Table 3-4-2-7).

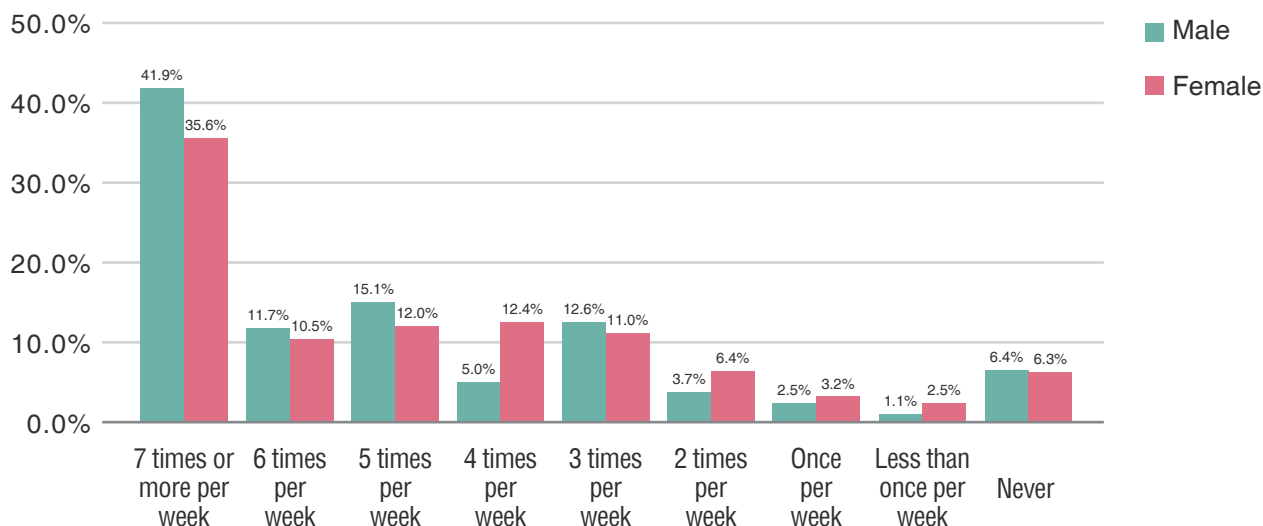

Figure 2-4-1-4 Proportion of male and female seniors' weekly exercise frequency

In terms of exercise time among senior subjects who participate in physical exercise, the proportion of males and females who exercise for less than 30 minutes each time accounted for 19.1% and 15.9%, respectively. 34.6% of males and 36.1% of females had an average exercise duration of 30~59 minutes. 38.2% of males and 41.0% of females exercise for 60~119 minutes each time and those who exercise for 120 minutes or more accounted for 8.1% and 7.0% in males and females, respectively. No significant gender difference was seen among groups (Figure 2-4-1-5 and Table 3-4-2-8).

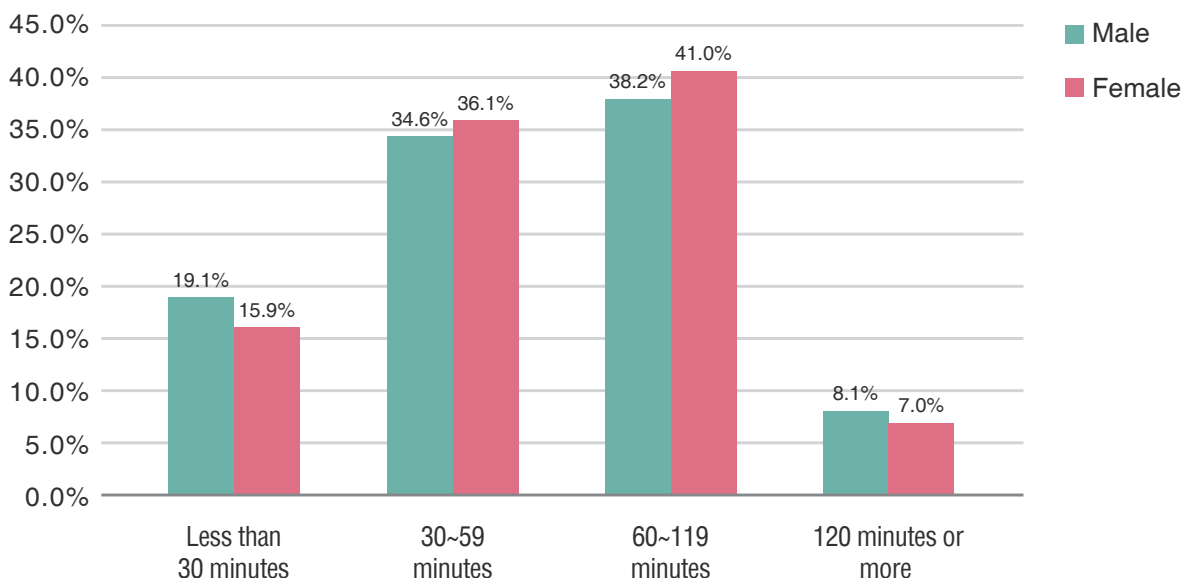

Figure 2-4-1-5 Proportion of male and female seniors' average exercise duration

In terms of exercise intensity, senior subjects who exercise at moderate or high intensity accounted for 64.2% for males and 66.6% for females, of which subjects who reach moderate intensity peaked with 48.1% for males and 50.8% for females, followed by low intensity at 35.8% for males and 33.4% for females. Those who reach high intensity accounted for the lowest proportion. No significant difference between genders was observed among different exercise intensity (Figure 2-4-1-6 and Table 3-4-2-9).

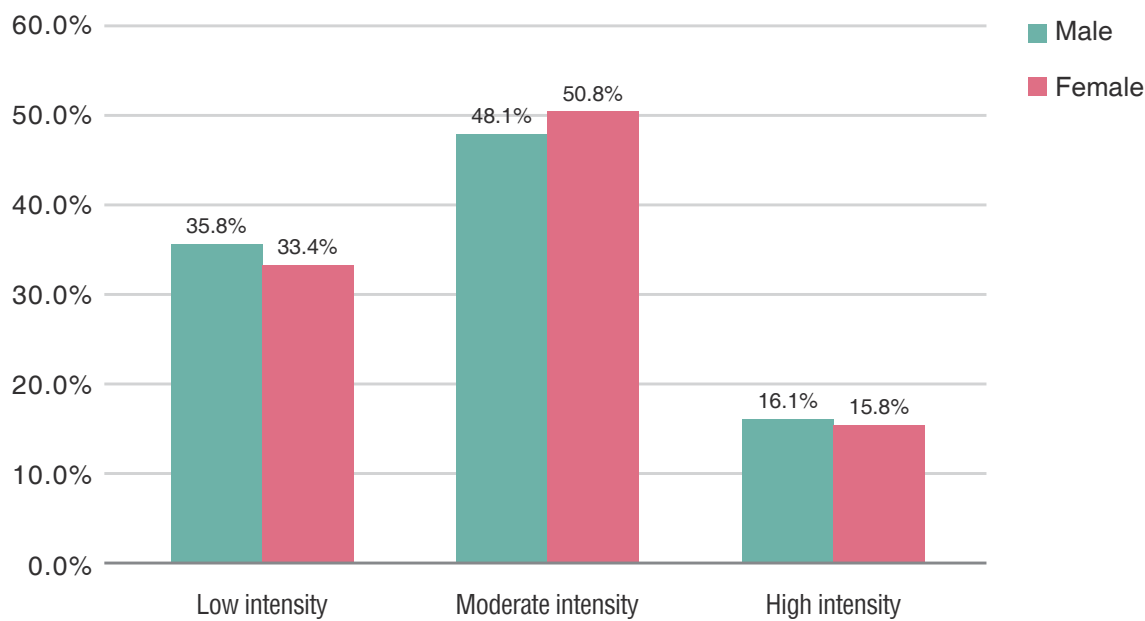

Figure 2-4-1-6 Proportion of male and female seniors' exercise intensity

Among senior subjects who participate in physical exercise, those who concurrently met all three criteria, including “exercising 3 or more times weekly”, “each session for 30 minutes or more” with “moderate exercise intensity or above” were defined as “frequent exercisers”. In 2020, the proportion of frequent exercisers, occasional exercisers and non-exercisers accounted for 47.2%, 46.5% and 6.3%, respectively. Specifically, the proportion of frequent exercisers accounted for 51.0%, 49.3%, 43.6% and 41.4% in the aged 60~64, 65~69, 70~74 and 75~79 groups, respectively. No significant gender difference was found among all age groups (Tables 3-4-2-10 and 3-4-2-11).

Among senior subjects who participate in physical exercise as per the given exercise frequency, duration and intensity, the proportion of seniors who persisted in exercising for one year or more was highest (81.3%), 78.2% for males and 82.9% for females with no significant gender difference. Followed by 6~12 months (7.3%), 9.9% for males and 6.1% for females, which differed significantly between genders ($P < 0.05$) (Table 3-4-2-12).

In addition, among senior subjects who participate in physical exercise, weekly frequencies of strength training (including bodyweight exercises such as push-ups, sit-ups, pull-ups, and squats; or equipment workout such as using dumbbells and elastic bands, etc.) were as follows: The proportion of seniors with no strength training habit was 81.4%, followed by the highest training frequency of seven days per week, accounting for 4.7%, and then 3.3% of seniors who train for three days per week. Significant gender difference was seen among all weekly frequencies ($P < 0.05$), except for those who train for one and two days per week (Figure 2-4-1-7, Table 3-4-2-13).

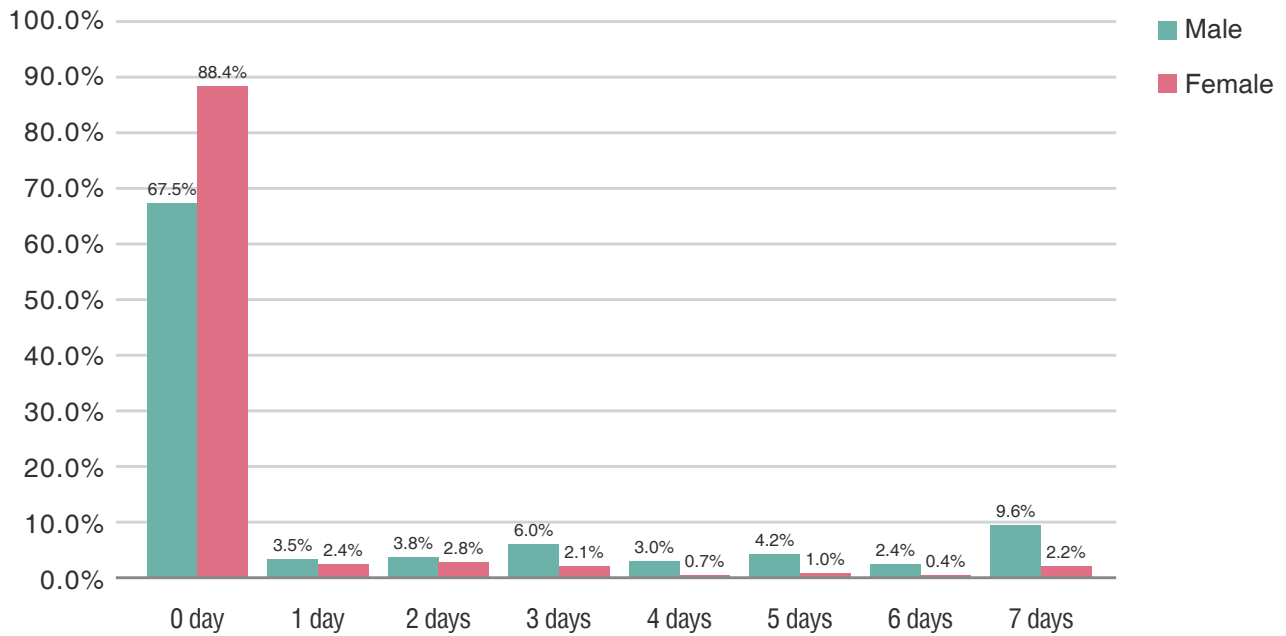

Figure 2-4-1-7 Proportion of weekly frequency of strength training in male and female seniors

The top six physical exercises in which senior subjects participated were walking (72.1%), swimming (26.9%), martial arts (18.6%), Qigong and dance (18.5% for both), and aerobics (18.4%). Males mostly participated in walking (76.3%), swimming (29.9%), running (23.5%), martial arts (14.3%), hiking or rock climbing (13.7%), and Qigong (12.3%); females mostly participated in walking (70.0%), dance (27.1%), swimming (25.4%), aerobics (22.2%), Qigong (21.6%), and martial arts (20.9%). In particular, the proportion of males who preferred walking was 6.3% higher than that of females ($P < 0.05$). Whereas the proportion of females was 9.3% higher than that of males in Qigong ($P < 0.05$), 6.6% higher than males in martial arts ($P < 0.05$), 25.7% higher than males in dance ($P < 0.05$), and 11.3% higher than males in aerobics ($P < 0.05$). It was worth mentioning that 6.0% of senior subjects were non-exercisers (Figure 2-4-1-8, Table 3-4-2-14).

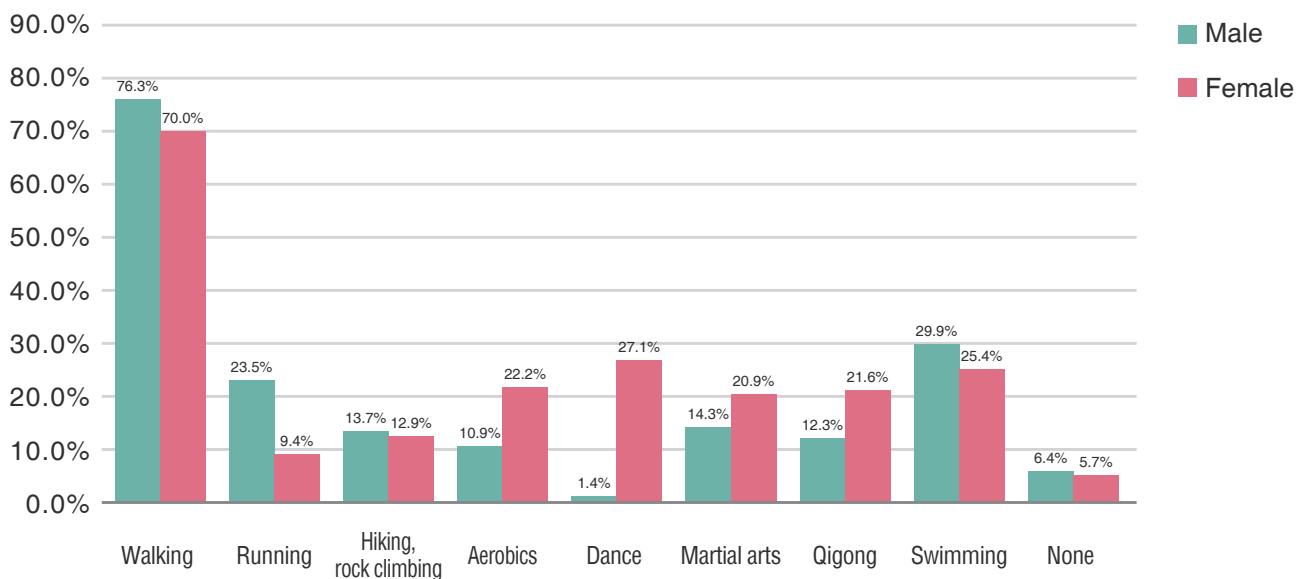

Figure 2-4-1-8 Proportion of participation in major physical exercises in male and female seniors

The major reasons seniors chose the above-mentioned exercises were as follows, in descending order: random choice (54.1%), convenient to practice (17.4%), making choice paralleled with their families/friends/colleagues (14.8%), and easy to practice (7.1%). More specifically, the proportion of males who exercise due to convenience accounted for 23.9%, which was 9.7% higher than that of females (14.2%) ($P < 0.05$); whereas the proportion of females who exercise due to their families/friends/colleagues accounted for 17.8%, which was 8.8% higher than that of males (9.0%) ($P < 0.05$) (Table 3-4-2-15).

The major obstacles that hindered seniors to participate in physical exercise were as follows, in descending order: burden of house chores (29.2%), busy work (20.1%), lack of venues (19.6%), lack of coaching advice (18.0%), concerns of injuries (17.0%), and lack of venues nearby (14.4%), etc. In particular, 34.2% of females were hindered due to house chores, which was 14.9% higher than that of males (19.3%) ($P < 0.05$), and 26.8% of males were hindered due to busy work, which was 10.0% higher than that of females (16.8%) ($P < 0.05$) (Table 3-4-2-16).

2.3 Occurrence of Diseases

The study results of 2020 showed that 75.7% of senior subjects had suffered from hospital-diagnosed diseases in the past five years, and the prevalence of disease in males (78.8%) was higher than that in females (74.2%), with no significant gender difference found. The highest prevalence was recorded in the aged 75~79 group, accounting for 91.8% and 82.2% of males and females, respectively. While the lowest prevalence was found in the aged 60~64 group, accounting for 64.9% and 68.3% in males and females, respectively. Among senior subjects with hospital-diagnosed diseases, the top five common diseases in descending order were hypertension (49.8%), hyperlipidemia (23.0%), diabetes (16.7%), heart disease (11.7%) and discopathy (10.0%). 11.9% of females and 6.4% of males had suffered from discopathy before, with a significant difference of 5.5% seen between genders ($P < 0.05$) (Tables 3-4-2-17 and 3-4-2-18).

2.4 Perception of the Physical Fitness Study

In 2020, the proportion of senior subjects who had heard of the physical fitness study was 57.9%, in which females (63.7%) was higher than that of males (46.4%) with significant difference ($P < 0.05$). Only 39.7% of seniors had previously participated in the physical fitness study, in which the proportion of females (45.3%) was also higher than that of males (27.4%), but with no significant gender difference. As age increased, the proportion of females who had previously participated in the physical fitness study tended to increase. In terms of perception of the physical fitness study, 92.4% of seniors considered it helpful to understand their own physical fitness status, which accounted for 92.5% of males and 92.3% of females with no significant difference found between genders.; Followed by those who considered it helpful to recognize the importance of physical exercise (76.0%), which accounted for 73.5% in males and 77.2% in females, without significant gender difference (Tables 3-4-2-19, 3-4-2-20 and 3-4-2-21).

2.5 Fitness Literacy

The study was based on the questionnaire survey conducted among Macao residents aged 3~79 in 2020. All the evaluative dimensions of scientific fitness literacy were examined in the aged 60~79 groups (subdivided into the aged 60~69, 70~79 groups), and the study results of the collected 1,074 samples were analyzed as follows:

2.5.1 Cognition

90% of senior subjects had the right perception of exercising. Similar to that of children, adolescents and adults, the majority of seniors had positive perception of exercising, and most of them considered exercising a positive activity beneficial for both physical and mental health. Over 90% of seniors believed that exercising can strengthen their body, relieve stress and hone the will. The situation of seniors in Mainland China was comparable to that of Macao seniors.

2.5.2 Attitude

Nearly 90% of senior subjects had a positive attitude towards exercising. Seniors had the highest proportion among all ages in holding a positive attitude towards exercising. Different from children, adolescents or adults, the proportion of seniors with positive perception and acceptance towards exercising was relatively similar, which suggested that seniors' perception and subjective evaluation towards exercising were highly consistent. Such attitude placed a solid emotional foundation for the subsequent transformation of their exercise intention into specific behaviors and habits (Figure 2-4-1-9).

In comparison, nearly 60% of seniors in Mainland China held a positive attitude towards exercising, and over 40% of them lost interest in physical exercise. The purpose of physical exercise was no longer the physical exercise itself for the majority of seniors.

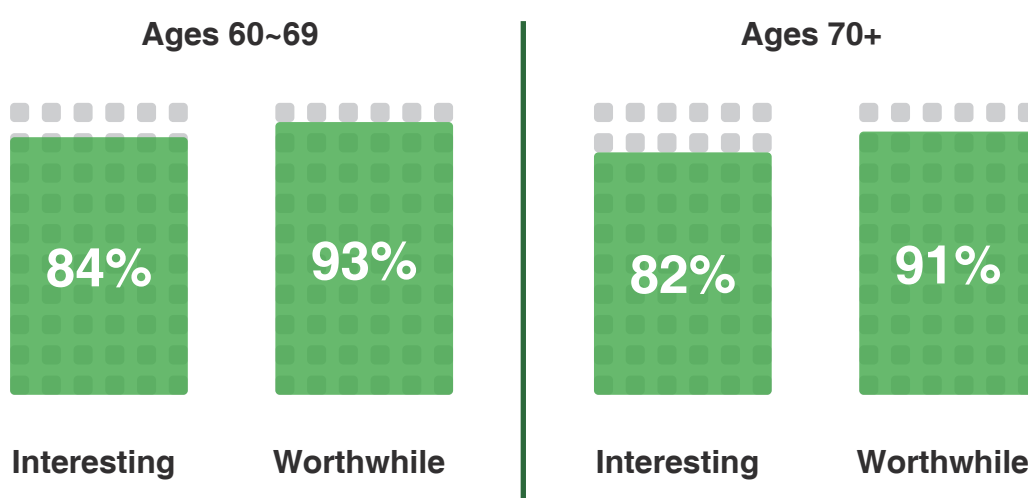

Figure 2-4-1-9 Proportion of acceptance towards exercising in seniors

In 2020, 80% of Macao seniors had strong desires for fitness, and approximately 60% of them were willing to take actual actions. Seniors achieved the highest proportion in the accurate cognition of their own fitness ability and the preparation needed to conduct exercise among all ages. Moreover, the higher the age was, the more obvious their behavior tendency became. This specific proportion increased with advancing age: from 31.0% between aged 13~18 to 39% between aged 30~39, afterwards reached 45% between aged 50~59, into 60% in seniors aged 70 onwards. It indicated that seniors were more voluntary and active about physical exercise.

2.5.3 Ability and Skill

The diversity of physical exercises in seniors was further reduced and exercise categories were rather monotonous. Due to physiological limitations, the types of exercises and categories were monotonous, the average number of exercises seniors aged 60~69 participated was 2.84 per person, and seniors aged 70 onwards was 2.41 per person. Seniors preferred exercises that require simple movement combinations with slow rhythm, and were less likely to participate in exercises that require strong skills or with high dependence on external conditions. In addition, swimming was still popular among seniors, as well as among all ages (Figure 2-4-1-10).

In comparison, the number of physical exercises seniors in Mainland China participated was fewer, with 1.85 exercises per person in the aged 60~69 groups and 1.45 per person in the aged 70+ groups.

2.5.4 Behavior and Habit

48% of senior subjects reached the amount of exercise recommended by the World Health Organization. According to the Guidelines on Physical Activity and Sedentary Behavior (2020 version) issued by WHO, the recommended amount of exercise for seniors aged 65 onwards is at least 150~300 minutes of moderate-intensity aerobic exercise or 75~150 minutes of high-intensity aerobic exercise, with at least two days of strength training. According to the criteria, the proportion of subjects who were able to reach the above criteria accounted for 50.7% and 42.9% in the aged 60~69 and 70+ groups, respectively. Based on the standards of frequent exercisers, 47.2% of all seniors were frequent exercisers, which accounted for 50.2% and 42.6% in the aged 60~69 and 70+ groups, respectively.





	60~69	70+
	Walking 71.9%	Walking 72.4%
	Swimming 31.5%	Martial arts 22.0%
	Dance 21.0%	Aerobics 21.5%
	Yoga, Pilates 17.3%	Qigong 21.1%
	Running, Qigong, aerobics, martial arts, hiking or rock climbing	Swimming, dance, table tennis, running, hiking or rock climbing

Figure 2-4-1-10 Proportion of physical exercise participation in seniors

3. Anthropometric Measurements

3.1 Length Indicators

The average height of male and female seniors decreased with advancing age, ranging from 162.7~166.5cm and 152.1~154.3cm, respectively. The average height of males was higher than that of females, which differed significantly between genders ($P < 0.05$) (Figure 2-4-1-11 and Table 3-4-3-1).

The average sitting height declined with advancing age in both males and females, ranging from 86.2~89.5cm for males and 81.1~83.6cm for females. Males had a higher average sitting height than females with significant gender difference ($P < 0.05$) (Figure 2-4-1-12 and Table 3-4-3-2).

The average foot length of seniors remained fairly stable, ranging from 24.2~24.7cm and 22.6~22.8cm for males and females, respectively. Males had a longer average foot length than females with significant gender difference ($P < 0.05$) (Figure 2-4-1-13 and Table 3-4-3-3).

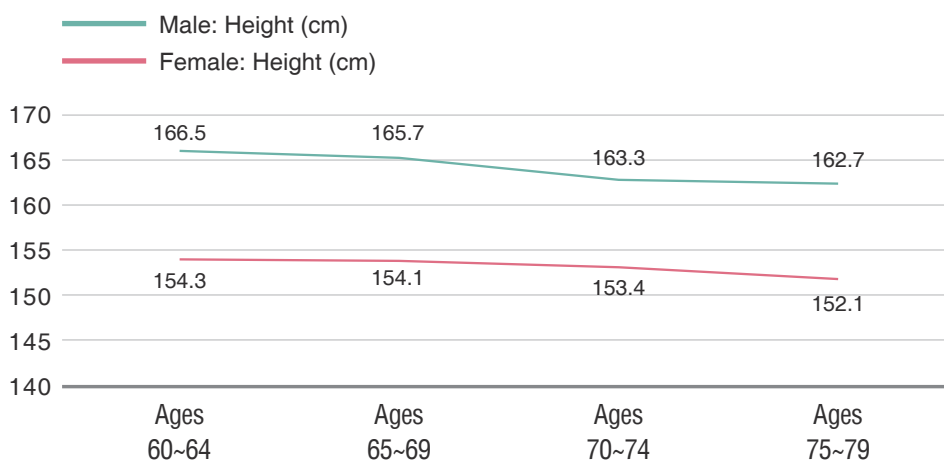

Figure 2-4-1-11 Average height of male and female seniors in each age group

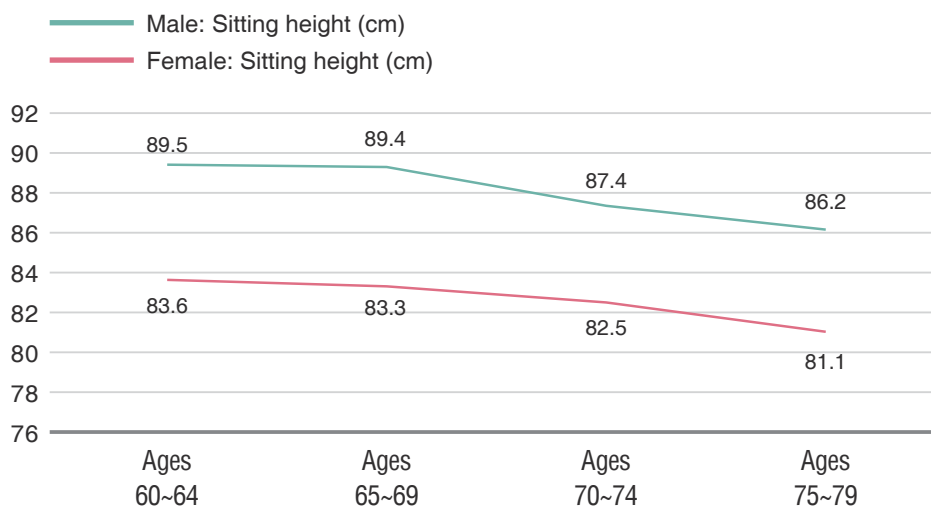

Figure 2-4-1-12 Average sitting height of male and female seniors in each age group

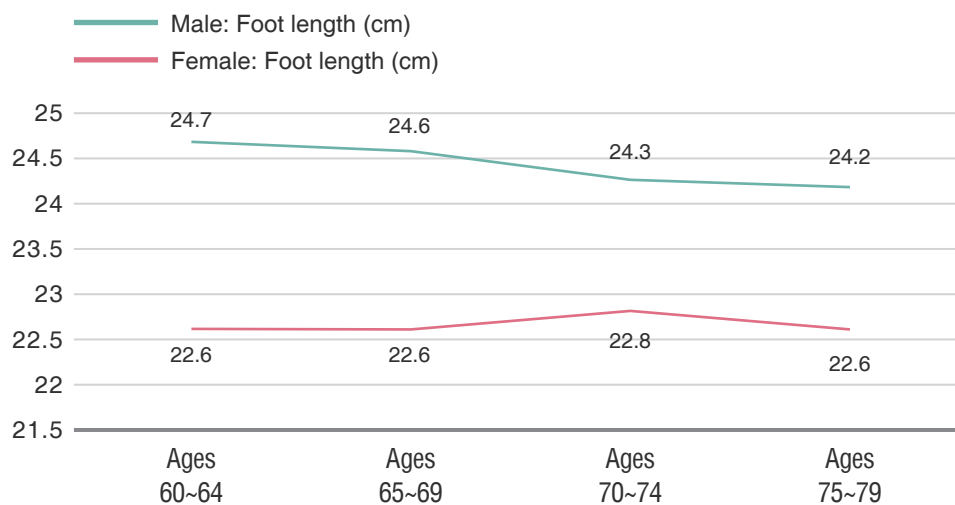

Figure 2-4-1-13 Average foot length of male and female seniors in each age group

3.2 Weight and BMI

Among male seniors aged 74 or younger and female seniors aged 65~79, the average weight decreased with advancing age, ranging from 64.1~65.5kg for males and 54.6~56.6kg for females. Significant difference was observed between genders ($P < 0.05$) (Figure 2-4-1-14 and Table 3-4-3-4).

Among male seniors aged 70 onwards and female seniors aged 60~79, the average BMI increased with advancing age, ranging from 23.8~24.3 for males and 22.9~24.1 for females. No significant gender difference was found (Figure 2-4-1-15 and Table 3-4-3-5).

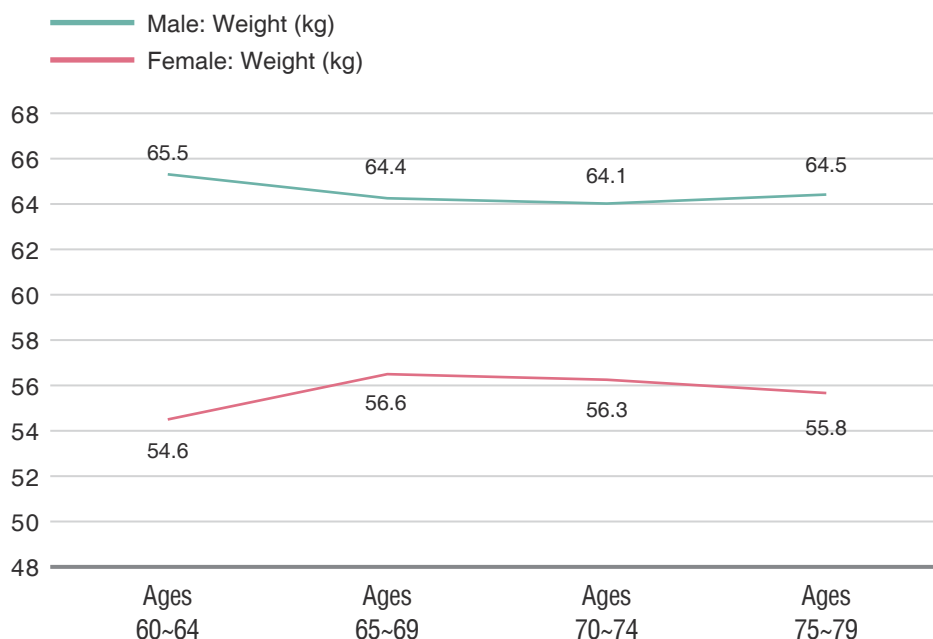

Figure 2-4-1-14 Average weight of male and female seniors in each age group

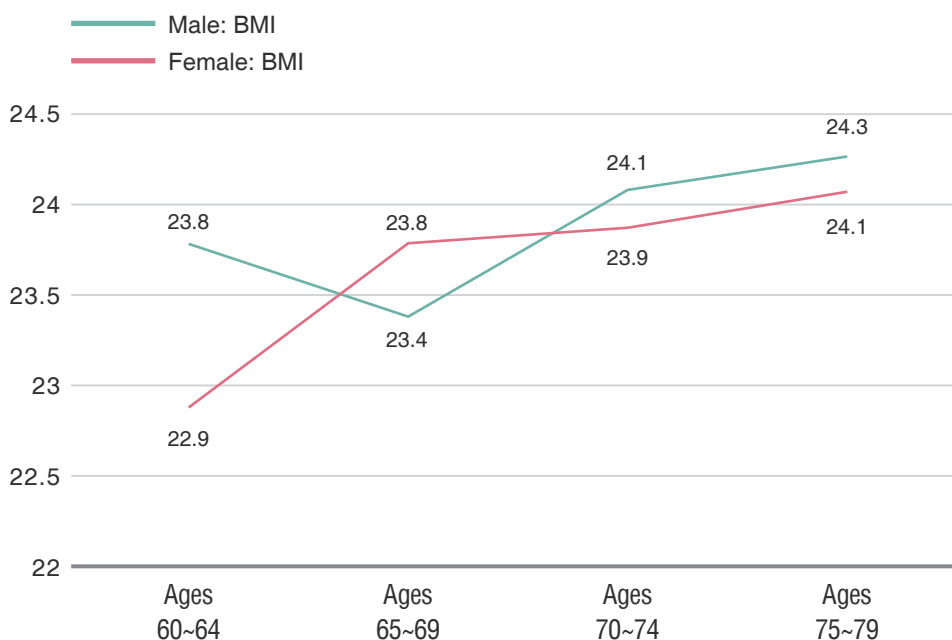

Figure 2-4-1-15 Average BMI of male and female seniors in each age group

Based on BMI classification of underweight, normal weight, overweight and obesity, our study results showed that: the prevalence of overweight and obesity of male seniors accounted for 40.5% and 6.4%, respectively, and the prevalence of overweight and obesity of female seniors accounted for 33.1% and 8.4%, respectively. Males had a higher prevalence of overweight than females which differed significantly between genders ($P < 0.05$). However, males had a lower prevalence of obesity than females without significant difference found between genders. According to the comparison among age groups, the prevalence of overweight and obesity of seniors exhibited an upward trend with advancing age, except for the prevalence of overweight among male seniors aged 65~69, the prevalence of obesity among male seniors aged 75~79, and the prevalence of overweight among female seniors aged 75~79 (Table 3-4-3-6).

3.3 Circumference Indicators

The average chest circumference of male seniors aged 65~79 decreased with advancing age, ranging from 90.4~92.5cm, whereas that of female seniors aged 60~74 increased with advancing age, ranging from 87.6~89.2cm. Significant difference was observed between genders ($P < 0.05$) (Figure 2-4-1-16 and Table 3-4-3-7).

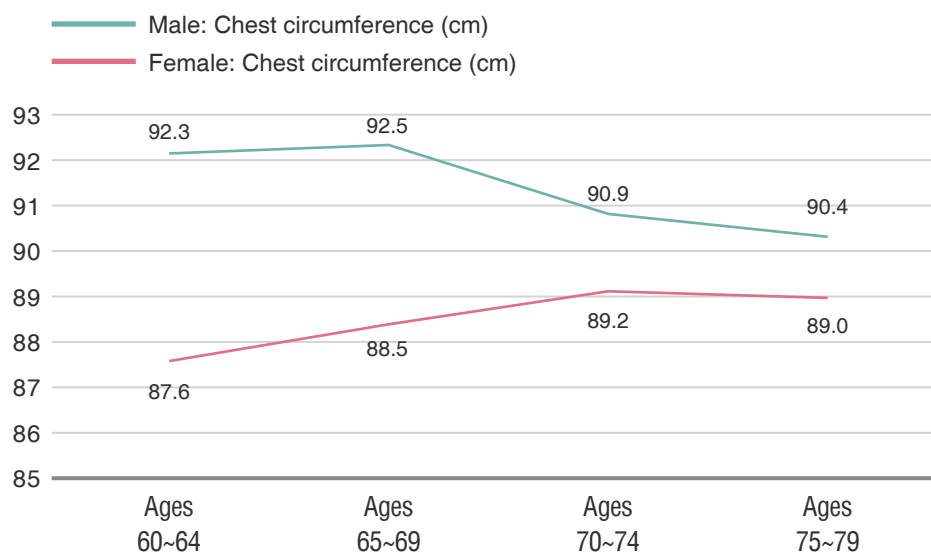

Figure 2-4-1-16 Average chest circumference of male and female seniors in each age group

The average waist circumference of male and female seniors increased with advancing age, ranging from 86.1~88.7cm and 81.4~87.7cm, respectively. The largest difference between genders was observed in the aged 60~64 group ($P < 0.05$) (Figure 2-4-1-17 and Table 3-4-3-8).

The average hip circumference of seniors aged 65~79 declined as age increased, ranging from 92.7~93.4cm and 93.1~94.5cm for males and females, respectively. The gender difference was not significant in seniors aged 60~64. Among seniors aged 65 onwards, the average hip circumference of males was lower than that of females, with significant gender difference ($P < 0.05$) (Figure 2-4-1-18 and Table 3-4-3-9).

The average waist-to-hip ratio (WHR) of male and female seniors both increased with advancing age, ranging from 0.921~0.956 for males and 0.873~0.928 for females. Males had a larger WHR than females with significant gender difference ($P < 0.05$) (Figure 2-4-1-19 and Table 3-4-3-10).

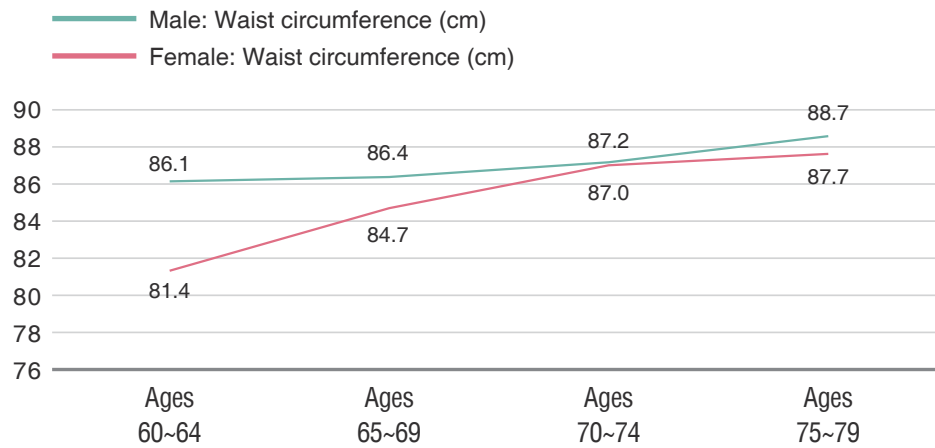

Figure 2-4-1-17 Average waist circumference of male and female seniors in each age group

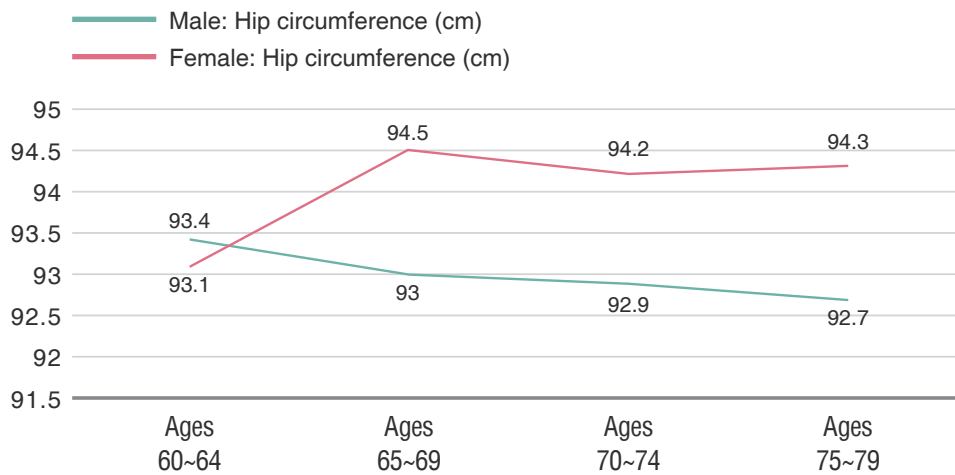

Figure 2-4-1-18 Average hip circumference of male and female seniors in each age group

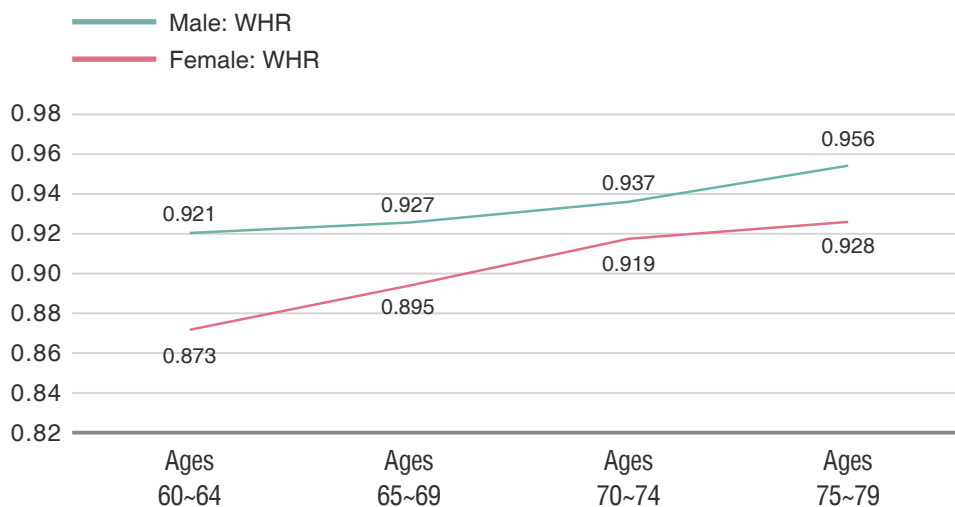

Figure 2-4-1-19 Average WHR of male and female seniors in each age group

3.4 Width Indicators

The average shoulder width of seniors remained almost constant as age increased, ranging from 37.6~38.5cm and 34.3~34.8cm for males and females, respectively. The average shoulder width of males was significantly higher than that of females ($P < 0.05$) (Figure 2-4-1-20 and Table 3-4-3-11).

The average pelvis width of seniors remained fairly stable with advancing age, ranging from 27.9~29.6cm and 28.5~29.0cm for males and females, respectively. Significant difference was found between genders ($P < 0.05$) (Figure 2-4-1-21 and Table 3-4-3-12).

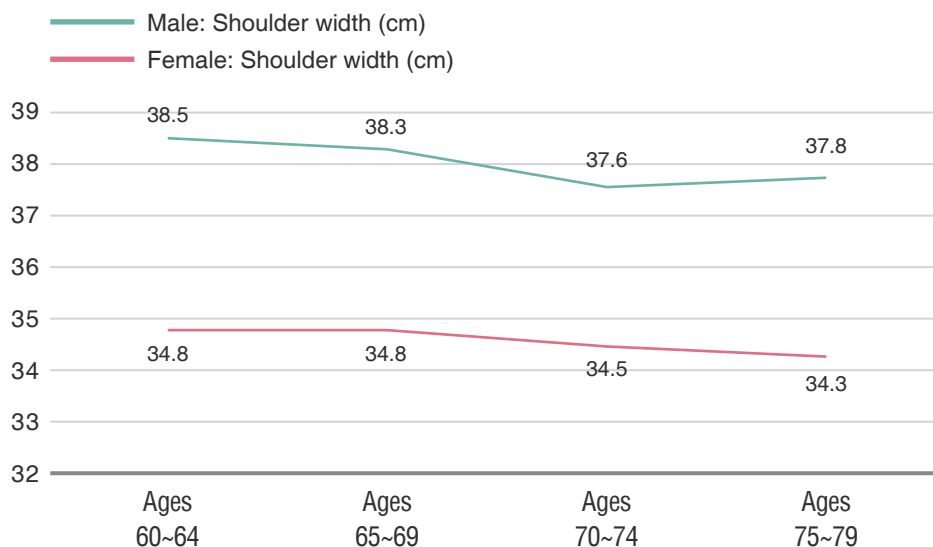

Figure 2-4-1-20 Average shoulder width of male and female seniors in each age group

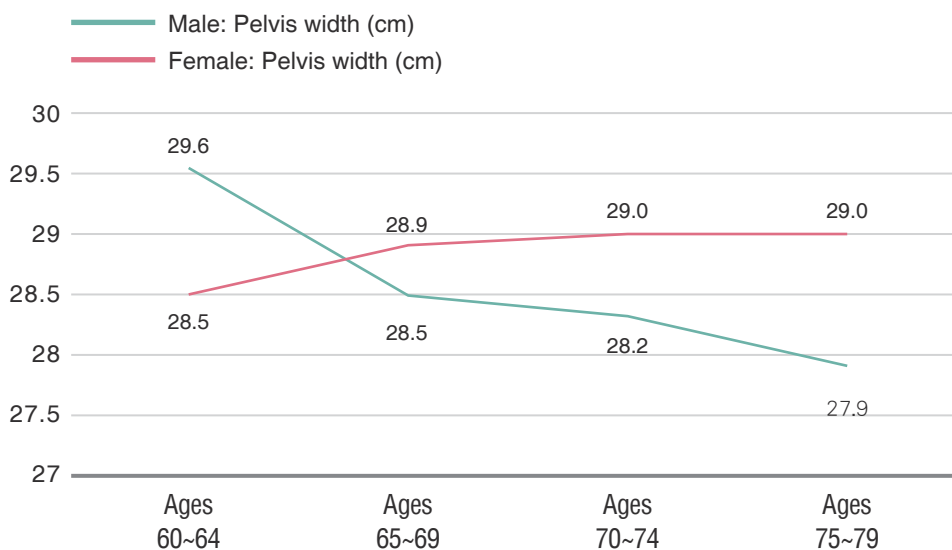

Figure 2-4-1-21 Average pelvis width of male and female seniors in each age group

3.5 Body Composition

As age increased, body fat percentage of seniors increased gradually. The average body fat percentage of males and females ranged from 21.8~22.7% and 30.5~32.4%, respectively. The average body fat percentage was significantly higher in females than males ($P < 0.05$) (Figure 2-4-1-22 and Table 3-4-3-13).

The average lean body mass of seniors varied mildly with advancing age, ranging from 49.4~50.6kg and 37.0~38.1kg for males and females, respectively. The average lean body mass of males was significantly higher than that of females ($P < 0.05$) (Figure 2-4-1-23 and Table 3-4-3-14).

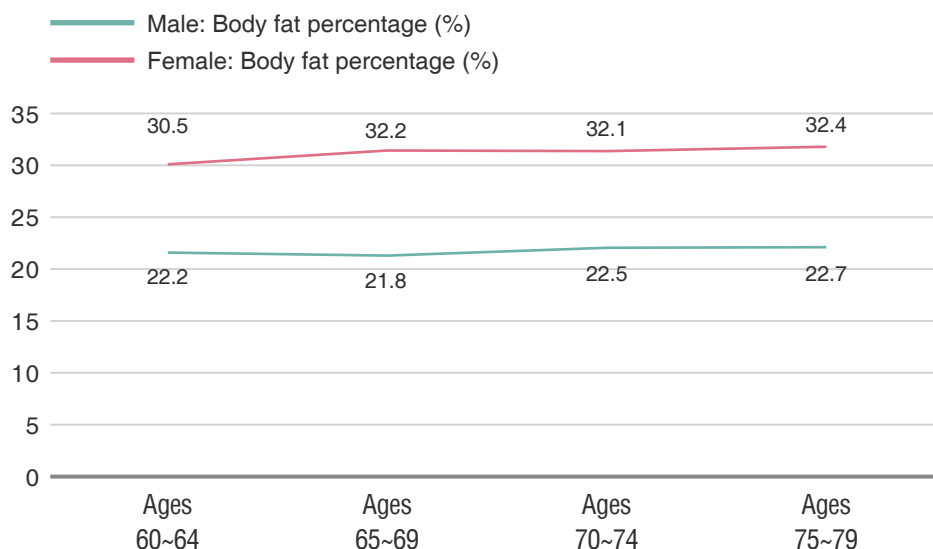

Figure 2-4-1-22 Average body fat percentage of male and female seniors in each age group

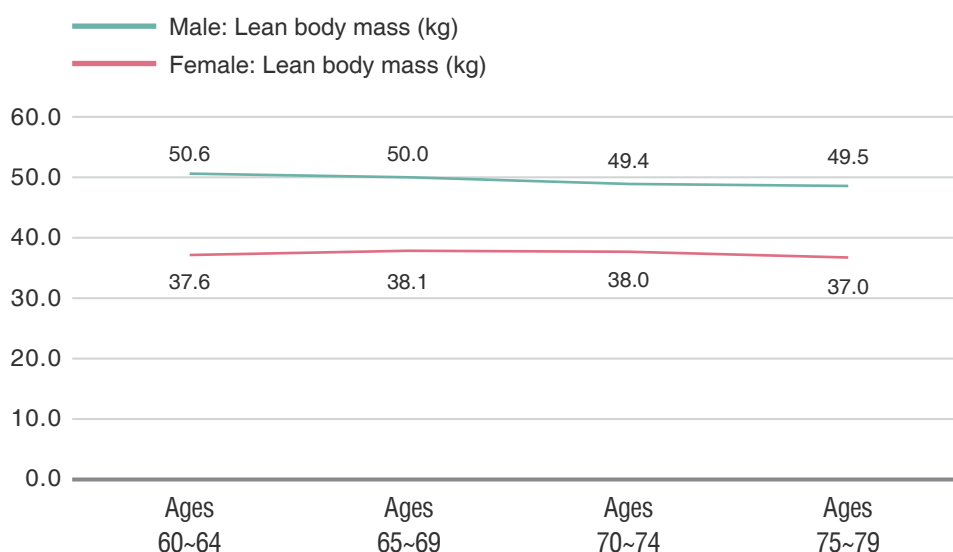

Figure 2-4-1-23 Average lean body mass of male and female seniors in each age group

4. Physiological Function

4.1 Resting Pulse

The average resting pulse of seniors remained stable as age increased, ranging from 71.6~74.1 bpm for males and 72.8~74.8 bpm for females. The biggest significant gender difference was found in the aged 75~79 group ($P < 0.05$) (Figure 2-4-1-24 and Table 3-4-4-1).

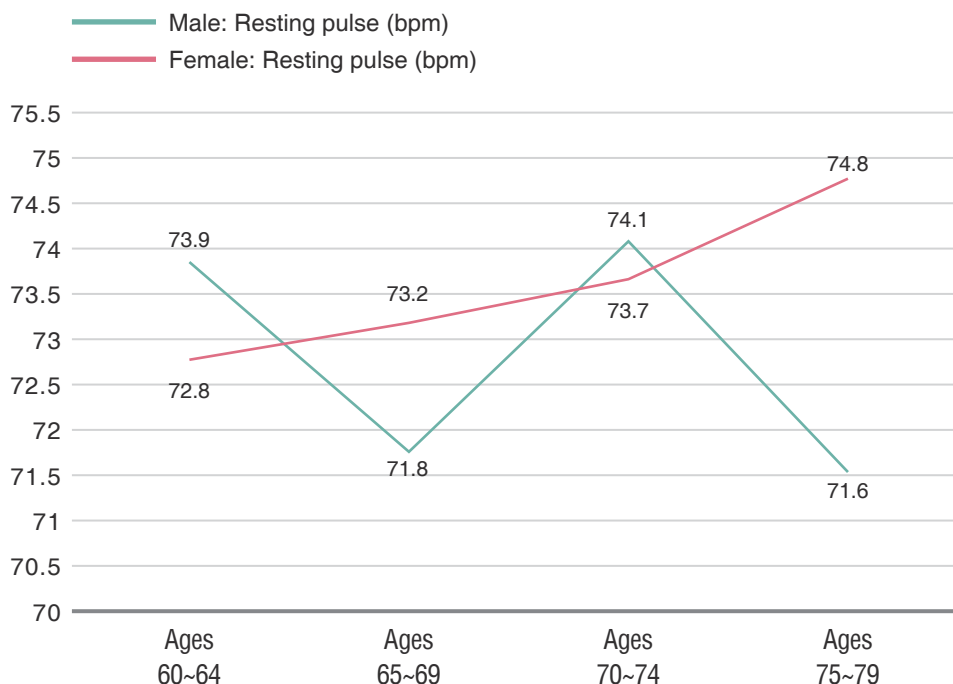

Figure 2-4-1-24 Average resting pulse of male and female seniors in each age group

4.2 Blood Pressure

The average systolic blood pressure (SBP) of male seniors was fairly stable as age increased, ranging from 136.2~137.8 mmHg, and that of female seniors varied with advancing age, between 130.7~137.9 mmHg. Significant difference was found between genders ($P < 0.05$) (Figure 2-4-1-25 and Table 3-4-4-2).

The average diastolic blood pressure (DBP) of male seniors aged 60~79 and female seniors aged 65 onwards decreased with advancing age, ranging from 70.7~78.0 mmHg and 69.4~75.3 mmHg for males and females, respectively. Significant gender difference was observed ($P < 0.05$) (Figure 2-4-1-26 and Table 3-4-4-3).

The average pressure difference of male and female seniors increased with advancing age, ranging from 58.2~67.3 mmHg and 57.5~68.4 mmHg, respectively. No significant gender difference was observed (Figure 2-4-1-27 and Table 3-4-4-4).

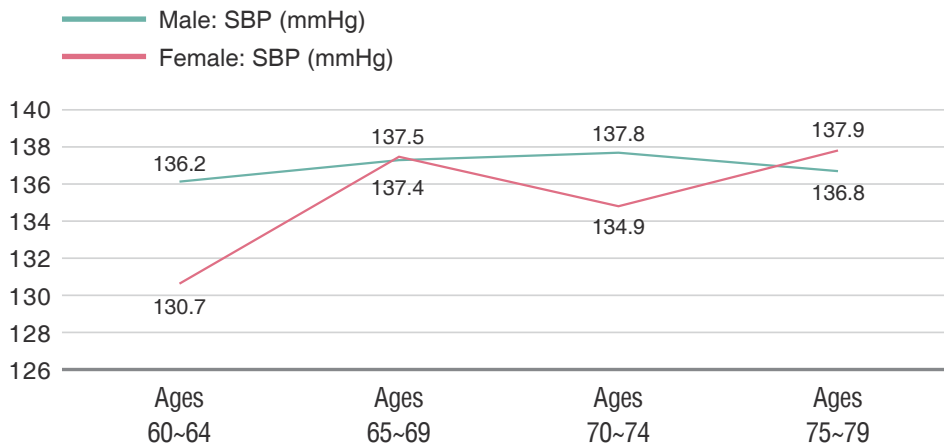

Figure 2-4-1-25 Average SBP of male and female seniors in each age group

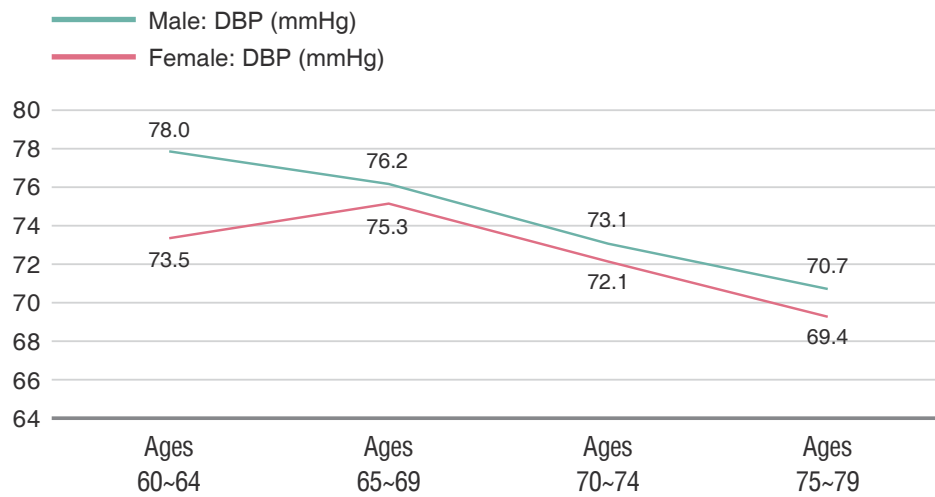

Figure 2-4-1-26 Average DBP of male and female seniors in each age group

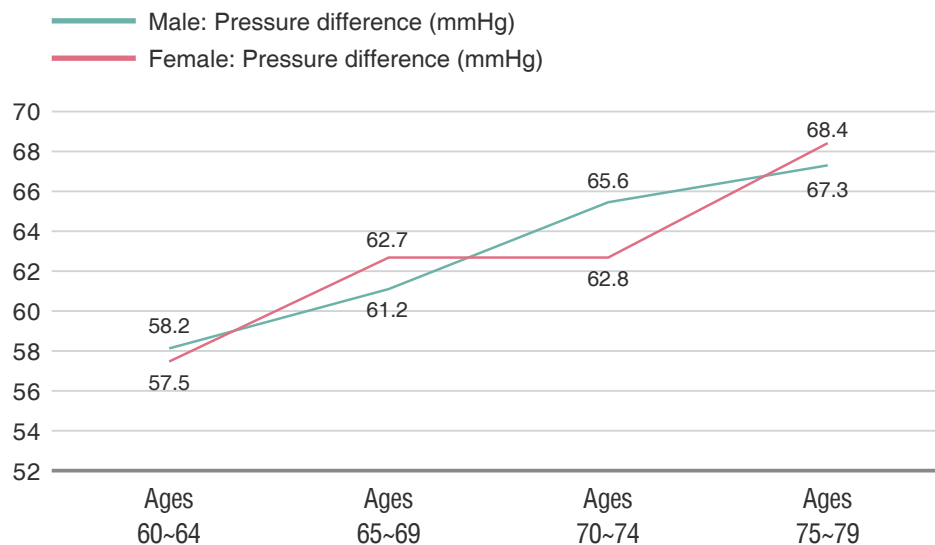

Figure 2-4-1-27 Average pressure difference of male and female seniors in each age group

4.3 Vital Capacity

The average vital capacity of male and female seniors decreased significantly with advancing age, and larger decrease was recorded in males than females. The average vital capacity ranged from 2175.3~3006.4ml and 1448.2~1982.5ml for males and females, respectively. Males had a higher vital capacity than females ($P < 0.05$) (Figure 2-4-1-28 and Table 3-4-4-5).

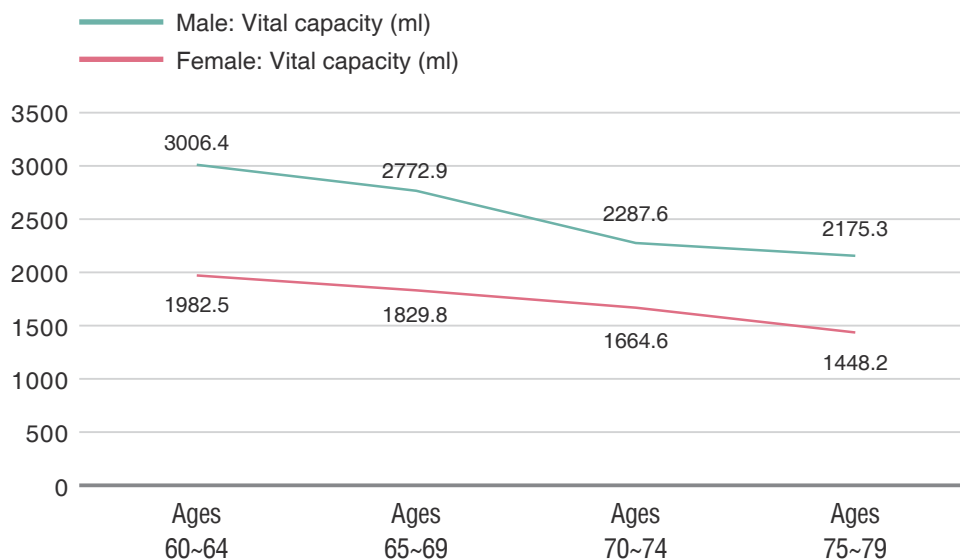

Figure 2-4-1-28 Average vital capacity of male and female seniors in each age group

The average vital capacity/weight of seniors decreased gradually with advancing age, ranging from 34.1~46.3 ml/kg for males and 26.7~36.9 ml/kg for females. Males had a significantly larger vital capacity/weight than females ($P < 0.05$) (Figure 2-4-1-29 and Table 3-4-4-6).

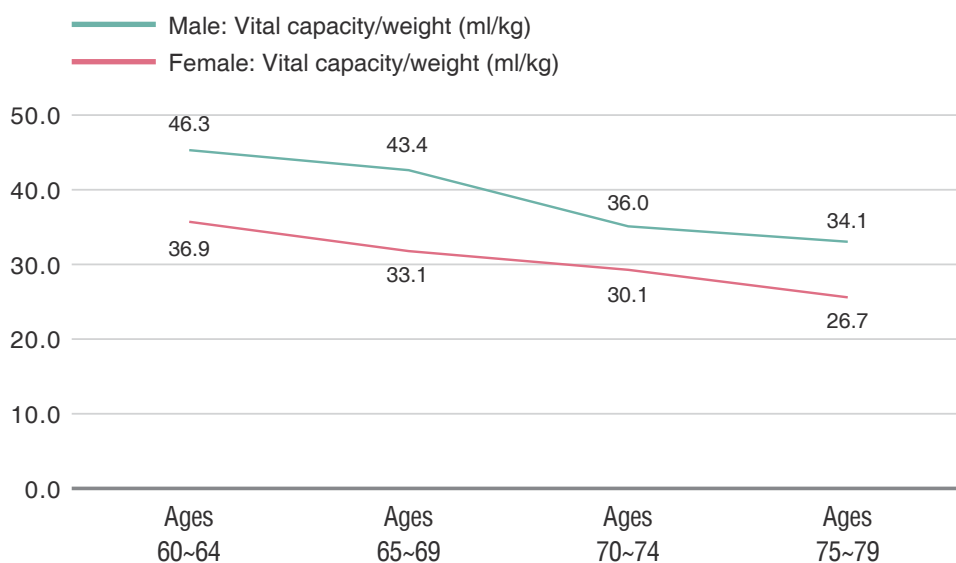

Figure 2-4-1-29 Average vital capacity/weight of male and female seniors in each age group

4.4 Two-minute High-knee Running in Place

Two-minute high-knee running in place reflects cardiorespiratory endurance.

The average 2-minute high-knee running in place of seniors tended to decrease with advancing age, ranging from 74.3~94.3 times for males and 79.6~90.9 times for females. Besides, the average 2-minute high-knee running in place was higher in females than males in the aged 70~74 group, and this gender difference was the largest when compared to all age groups ($P < 0.05$) (Figure 2-4-1-30 and Table 3-4-4-7).

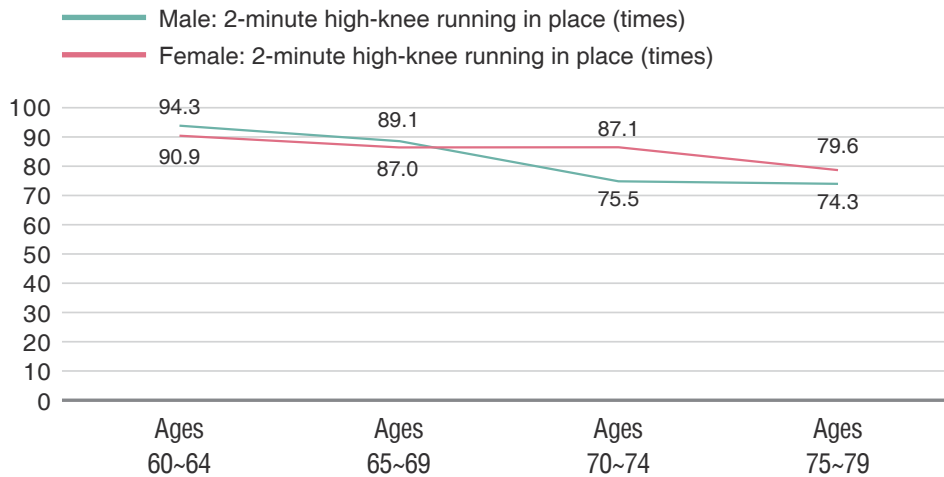

Figure 2-4-1-30 Average 2-minute high-knee running in place of male and female seniors in each age group

5. Physical Fitness

5.1 Strength

Grip strength reflects strength.

The average grip strength of seniors decreased with advancing age, ranging from 28.3~36.4kg and 18.9~21.2kg for males and females, respectively. Males had significantly higher strength than females across all age groups ($P < 0.05$) (Figure 2-4-1-31 and Table 3-4-5-1).

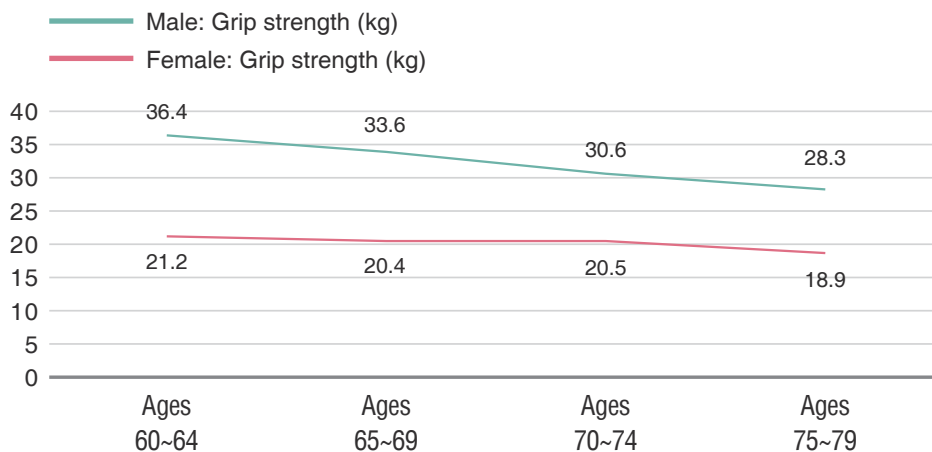

Figure 2-4-1-31 Average grip strength of male and female seniors in each age group

30-second chair stand reflects strength endurance. The average 30-second chair stand (times) of senior subjects exhibited a downward trend as age increased, ranging from 15.4~18.0 times for males and 15.4~17.0 times for females. The difference was not significant between genders (Figure 2-4-1-32 and Table 3-4-5-2).

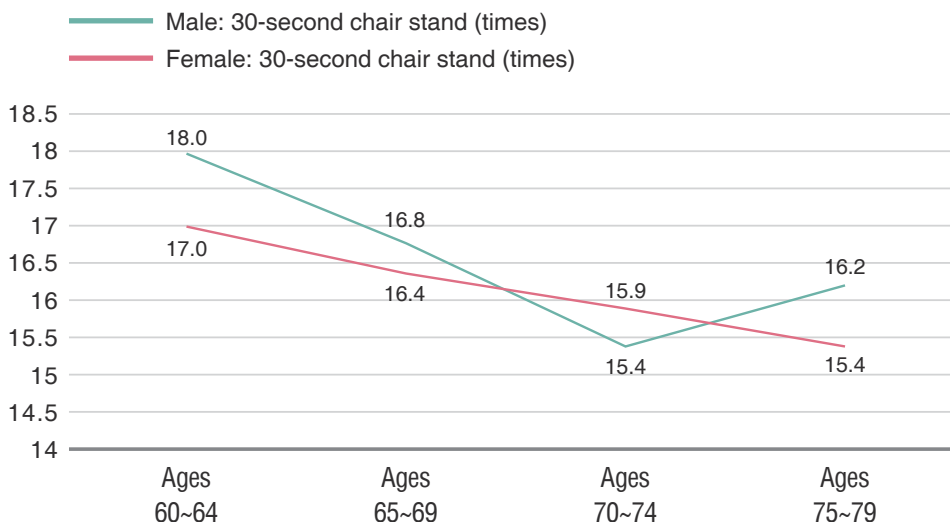

Figure 2-4-1-32 Average 30-second chair stand (times) of male and female seniors in each age group

5.2 Flexibility

Sit and reach reflects flexibility.

The average sit and reach score of seniors decreased as age increased, ranging from -7.3~0.6cm for males and 4.4~6.7cm for females. Males had significantly less flexibility than females ($P < 0.05$) (Figure 2-4-1-33 and Table 3-4-5-3).

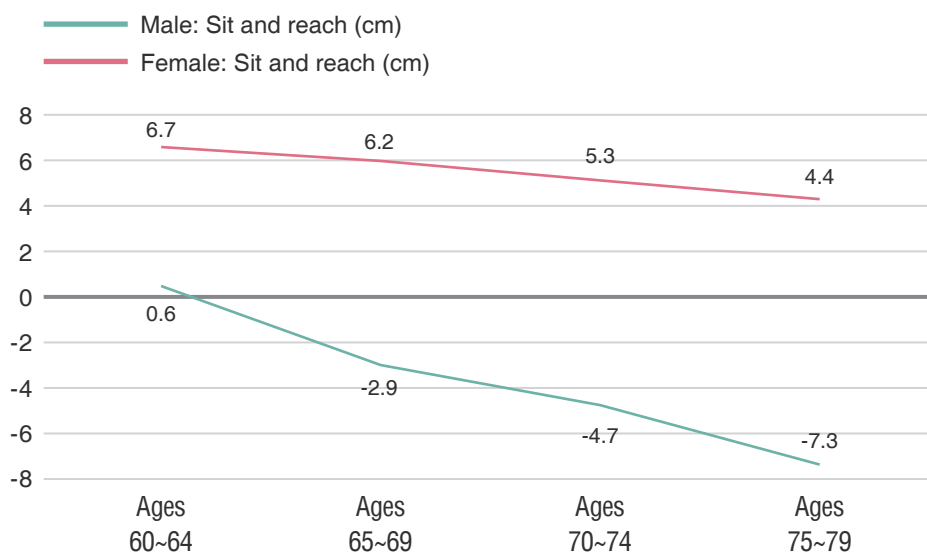

Figure 2-4-1-33 Average sit and reach score of male and female seniors in each age group

5.3 Reaction

Choice reaction time reflects reaction.

The average choice reaction time of seniors increased with advancing age, ranging from 0.48~0.63 seconds and 0.52~0.61 seconds for males and females, respectively. It indicated that reaction of seniors was reduced with advancing age. Males had faster reaction than females before aged 70, whereas females had faster reaction than males after aged 70. Significant difference was found between genders in all age groups except for the aged 70~74 group ($P < 0.05$) (Figure 2-4-1-34 and Table 3-4-5-4).

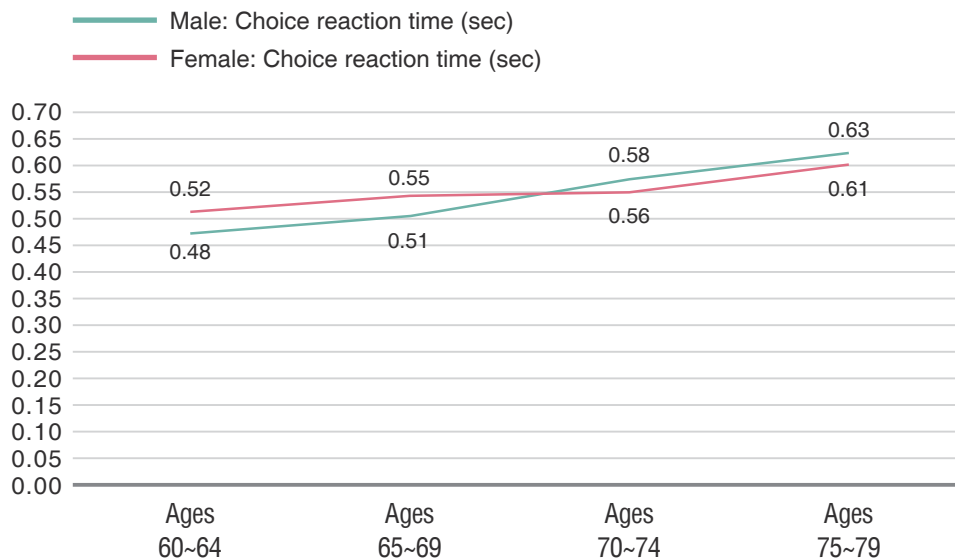

Figure 2-4-1-34 Average choice reaction time of male and female seniors in each age group

5.4 Balance

One foot stands with eyes closed (OFSEC) reflects balance.

As age increased, the average OFSEC time of male seniors decreased in those aged 60~74, while that of females decreased in all age groups. The average OFSEC time of males and females ranged from 5.7~12.4 seconds and 4.8~9.8 seconds, respectively. Males had better balance than females in aged 60~64, but females had better balance than males in aged 70~74. Both of these age groups were found to differ significantly between genders ($P < 0.05$) (Figure 2-4-1-35 and Table 3-4-5-5).

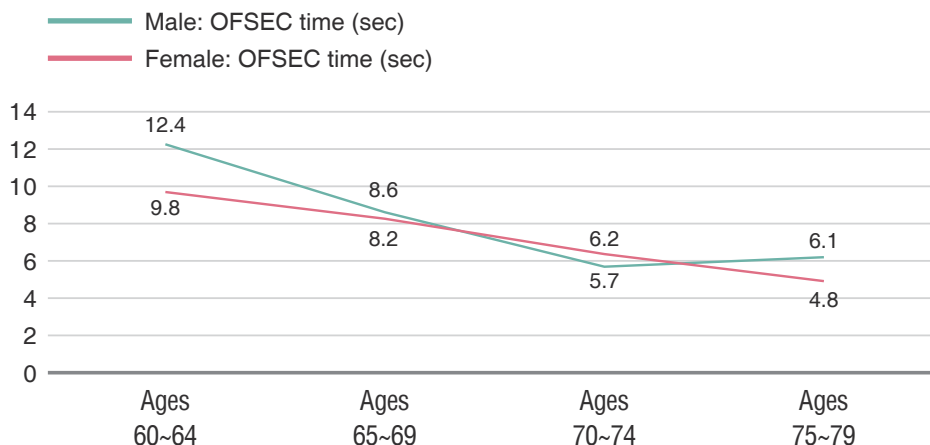

Figure 2-4-1-35 Average OFSEC time of male and female seniors in each age group

(II) Comparison of 2020 and 2015 Results on the Physical Fitness Study of Macao Seniors

The 2020 study was conducted among seniors aged 60~79, while the 2015 study was conducted among seniors aged 60~69. Thus, the comparison of results in this section was only conducted in the aged 60~69 groups.

1. Overall Comparison of Seniors by Age

1.1 Comparison of Basic Information

In 2020, the total number of senior subjects aged 60~69 was 647, basically consistent to the 638 subjects in 2015. Compared with the results in 2015, the proportion of seniors born in Mainland China had decreased substantially, whereas those born in Macao had increased significantly ($P<0.05$), especially females. The proportion of males born in Mainland China had decreased by 14.3% ($P<0.05$) and that of females had decreased by 25.9% ($P<0.05$). The proportion of males born in Macao had increased by 13.0% ($P<0.05$) and that of females had increased by 24.2% ($P<0.05$) (Table 2-4-2-1).

Table 2-4-2-1 Comparison of birthplaces in male and female seniors between 2020 and 2015 (%)

Birthplace	Male			Female		
	2020	2015	Difference	2020	2015	Difference
Mainland China	44.4	58.7	-14.3*	48.2	74.1	-25.9*
Macao	44.3	31.3	13.0*	40.9	16.7	24.2*
Hong Kong	6.8	2.0	4.8*	2.6	2.3	0.3
Portugal	1.1	0.5	0.6	0.2	0.0	0.2
Others	3.4	7.5	-4.1	8.1	6.9	1.2

Note: Difference is calculated using the 2015 data deducted from the 2020 data.
The asterisk "*" means $P<0.05$, which applies to subsequent tables.

In terms of comparison of educational level between 2020 and 2015, educational level of seniors had obviously improved in 2020, and a substantial decrease in proportion was found in those with education level of primary school or below. Compared with the results in 2015, the proportion of male seniors with education level of primary school or below and with doctoral degree had decreased in 2020, and those with other education qualifications had increased. For female seniors, the proportion of those with primary school education level had decreased by 9.7% in 2020 compared to that in 2015 ($P<0.05$), while the proportion had increased in those with secondary education level or above, of which the proportion in those with secondary education level and post-secondary or tertiary education level had increased by 14.0% and 6.0%, respectively ($P<0.05$) (Table 2-4-2-2).

Table 2-4-2-2 Comparison of educational levels in male and female seniors between 2020 and 2015 (%)

Education level	Male			Female		
	2020	2015	Difference	2020	2015	Difference
Below primary school education level	7.3	9.5	-2.2	11.3	23.1	-11.8
Primary school	17.9	22.9	-5.0	29.2	38.9	-9.7*
Secondary school	59.5	55.7	3.8	47.6	33.6	14.0*
Post-secondary / tertiary	12.4	10.9	1.5	10.4	4.4	6.0*
Master	2.8	0.5	2.3	0.7	0.0	0.7
Doctoral	0.0	0.5	-0.5	0.8	0.0	0.8

1.2 Comparison of Lifestyle

Four areas of lifestyle information including living habits, physical exercise, occurrence of diseases and perception of the physical fitness study were examined. Comparison of the results in 2020 and 2015 was as follows:

1.2.1 Living Habits

Compared with the results in 2015, the proportion of seniors who sleep for less than six hours (including naps) decreased substantially in 2020 ($P < 0.05$) and the proportion of those who sleep for 6~9 hours increased significantly ($P < 0.05$), showing that the sleeping time of seniors in Macao had increased in 2020 (Table 2-4-2-3).

Table 2-4-2-3 Comparison of average daily sleep time (including naps) in male and female seniors between 2020 and 2015 (%)

Sleep time	Male			Female		
	2020	2015	Difference	2020	2015	Difference
Less than 6 hours	6.7	22.9	-16.2*	13.6	33.9	-20.3*
6~9 hours	80.3	70.6	9.7*	80.4	63.6	16.8*
9 hours or more	12.9	6.5	6.4*	6.0	2.5	3.5*

Compared with the results in 2015, the average daily accumulated sitting time of senior subjects increased in 2020, and the proportion of seniors who sit for an average of 3~6 hours decreased. Specifically, the proportion of male and female seniors who sit for an average of less than three hours daily declined by 11.6% and 19.2%, respectively ($P < 0.05$). The proportion of those who sit for an average of six hours or more had increased significantly. In particular, the proportion of male and female seniors with an average daily sitting time of 6~9 hours had increased by 13.2% and 20.1%, respectively ($P < 0.05$) (Table 2-4-2-4).

Table 2-4-2-4 Comparison of average daily accumulated sitting hours in male and female seniors between 2020 and 2015 (%)

Average accumulated sitting time	Male			Female		
	2020	2015	Difference	2020	2015	Difference
Less than 3 hours	11.8	23.4	-11.6*	14.5	33.7	-19.2*
3~6 hours	44.9	53.7	-8.8	47.5	51.3	-3.8
6~9 hours	32.6	19.4	13.2*	31.1	11.0	20.1*
9~12 hours	7.9	3.5	4.4	4.7	3.4	1.3
12 hours or more	2.8	0.0	2.8*	2.1	0.7	1.4

1.2.2 Physical Exercise

In 2020, 50.2% of senior subjects aged 60~69 participated in physical exercises frequently, which had increased by 11.6% compared to 38.6% in 2015.

In terms of exercise frequency, the proportion of males who never exercised, exercise less than once per week, and exercise 3~4 times per week had decreased considerably in 2020 ($P < 0.05$), but those who exercise five times or more per week had increased significantly by 29.7% ($P < 0.05$). For females, the most significant decrease of 4.8% was observed in those who never exercised ($P < 0.05$), followed by those who exercise 1~2 times. The proportion of those who exercise 3~4 times per week had increased by 7.7% in 2020 ($P < 0.05$), and those who exercise five times or more per week had also increased by 0.5% with no significant difference found (Table 2-4-2-5).

Table 2-4-2-5 Comparison of weekly exercise frequencies in male and female seniors between 2020 and 2015 (%)

Exercise frequency	Male			Female		
	2020	2015	Difference	2020	2015	Difference
Never	8.4	15.9	-7.5*	6.4	11.2	-4.8*
Less than once	1.1	8.5	-7.4*	3.4	3.4	0.0
1~2 times	8.4	11.4	-3.0	11.5	14.9	-3.4
3~4 times	18.6	30.3	-11.7*	26.7	19.0	7.7*
5 times or more	63.5	33.8	29.7*	52.0	51.5	0.5

Among senior subjects who participate in physical exercise, their exercise duration had increased considerably in 2020 compared with that in 2015. The proportion of males who exercise for 60 minutes or more had increased by 10%. The proportion of females who exercise for 30~60 minutes had decreased by 11.8% ($P<0.05$), and those who exercise for 60 minutes or more had increased by 7.8% ($P<0.05$).

In terms of self-perception of physical exercise, the proportion of seniors who reached high exercise intensity had increased substantially in 2020 compared with that in 2015. In particular, the proportion of female seniors who feel little change in breathing and heart rate during physical exercise had decreased by 10.6% ($P<0.05$). The proportion of male and female seniors who had significantly increased breathing, heart rate and sweating when exercising had increased by 16.4% and 8.2% , respectively ($P<0.05$) (Table 2-4-2-6).

Table 2-4-2-6 Comparison of exercise duration and self-perception in male and female seniors between 2020 and 2015(%)

Exercise duration and self-perception	Male			Female		
	2020	2015	Difference	2020	2015	Difference
Less than 30 minutes	12.9	16.6	-3.7	17.7	13.7	4.0
30~60 minutes	38.0	44.4	-6.4	35.1	46.9	-11.8*
60 minutes or more	49.1	39.1	10.0	47.2	39.4	7.8*
Little change in breathing & heart rate	27.0	33.2	-6.2	29.6	40.2	-10.6*
Slightly increased breathing & heart rate with slight sweating	45.4	55.6	-10.2	52.8	50.4	2.4
Significantly increased breathing & heart rate with more sweating	27.6	11.2	16.4*	17.6	9.4	8.2*

In terms of exercise persistence, the proportion of male seniors who persisted in exercising for less than six months had increased by 3.4% in 2020. Whereas those who persisted in exercising for 6~12 months and one year or more had decreased by 0.3% and 3.1%, respectively. For female seniors, the proportion of those who persisted in exercising for less than six months had decreased by 0.1%, those who persisted in exercising for 6~12 months had increased by 2.3%, and those persisted in exercising for one year or more had decreased by 2.1%, with no significant difference found (Table 2-4-2-7).

Table 2-4-2-7 Comparison of duration of persistent exercising in male and female seniors between 2020 and 2015 (%)

Duration of persistent exercising	Male			Female		
	2020	2015	Difference	2020	2015	Difference
Less than 6 months	13.5	10.1	3.4	10.7	10.8	-0.1
6~12 months	8.0	8.3	-0.3	8.2	5.9	2.3
1 year or more	78.5	81.6	-3.1	81.1	83.2	-2.1

According to major obstacles that hindered exercise participation, the proportion of male seniors who did not exercise due to lack of interest had decreased by 1.9% in 2020, other obstacles were found to have increased in varying degree. Except for a lack of time, significant difference was seen in all other obstacles between 2015 and 2020 ($P<0.05$). For female seniors, the proportion of those who were hindered in physical exercise due to lack of interest had decreased by 0.3%, and those due to a lack of time had decreased by 17.6% ($P<0.05$). Significant increase was observed in all other obstacles between 2015 and 2020 ($P<0.05$) (Table 2-4-2-8).

Table 2-4-2-8 Comparison of obstacles to participating in physical exercise in male and female seniors between 2020 and 2015(%)

Obstacles	Male			Female		
	2020	2015	Difference	Diferença	2015	Difference
Lack of interest	6.2	8.1	-1.9	4.7	5.0	-0.3
Lack of time	37.6	29.4	8.2	21.3	38.9	-17.6*
Lack of venues and facilities	21.9	8.6	13.3*	18.1	3.0	15.1*
Lack of coaching advice	18.0	3.0	15.0*	20.7	2.5	18.2*
Lack of organization	8.4	2.5	5.9*	8.5	3.4	5.1*
Financial restraint	4.5	0.5	4.0*	2.6	0.7	1.9*

1.2.3 Occurrence of Diseases and Perception of the Physical Fitness Study

In 2020, 71.1% of senior subjects had been diagnosed with diseases in the past five years, which was higher than the proportion of 59.7% in 2015.

Compared with the results in 2015, the proportion of male seniors who had heard of and who had previously participated in the physical fitness study in 2020 had decreased by 0.4% and 9.2%, respectively, with no significant difference found. For female seniors, the proportion had increased significantly by 6.9% in those who had heard of the physical fitness study ($P<0.05$), and those who had previously participated in the physical fitness study had increased by 4.8% with no significant difference (Table 2-4-2-9).

Table 2-4-2-9 Comparison of male and female seniors who had heard of or previously participated in the physical fitness study between 2020 and 2015 (%)

Heard of or participation status	Male			Female		
	2020	2015	Difference	2020	2015	Difference
Heard of	57.3	57.7	-0.4	64.8	57.9	6.9
Never heard of	42.7	42.3	0.4	35.2	42.1	-6.9*
Participated previously	28.6	37.8	-9.2	41.6	36.8	4.8
Never participated	71.4	62.2	9.2	58.4	63.2	-4.8

In terms of perception of the physical fitness study, the proportion of male and female seniors who considered the physical fitness study “meaningless” had decreased in 2020, with significant difference found in females ($P<0.05$), but not in males. The proportion of male seniors who perceived the “physical fitness study” as “understanding their own physical fitness status” had increased significantly, by 6.6% in 2020 compared with that in 2015 ($P<0.05$), and that of female seniors had also increased by 3.3%, but with no significant difference. The proportion of those who perceived the “physical fitness study” as “recognizing the importance of physical exercise” and “improving knowledge of scientific fitness” had increased remarkably, with statistical significance ($P<0.05$) (Table 2-4-2-10).

Table 2-4-2-10 Comparison of perception of the physical fitness study in male and female seniors between 2020 and 2015(%)

Perception of the physical fitness study	Male			Female		
	2020	2015	Difference	2020	2015	Difference
Meaningless	3.4	4.5	-1.1	3.0	6.2	-3.2*
Understand the physical fitness status of oneself	92.7	86.1	6.6*	93.4	90.1	3.3
Recognize the importance of physical exercise	71.9	44.8	27.1*	77.2	36.9	40.3*
Improve knowledge of scientific fitness	64.0	31.8	32.2*	71.0	30.3	40.7*

1.3 Comparison of Study Indicators

Compared with the results in 2015, the indicators of diastolic blood pressure, pelvis width, choice reaction time, OFSEC, systolic blood pressure and hip circumference of male seniors aged 60~69 had increased in 2020, with the difference ranging from 2.0%~4.7%. While indicators including vital capacity, resting pulse, grip strength and sit and reach had decreased, with the difference ranging from 1.4%~7.0%, and all other indicators had varied mildly within 1.0% (Figure 2-4-2-1). For female seniors aged 60~69, indicators including OFSEC, choice reaction time, diastolic blood pressure, shoulder width, pelvis width and systolic blood pressure had increased by 1.0%~10.7%, indicators including foot length, chest circumference, sit and reach, BMI, weight and grip strength had decreased by 1.0%~5.8%, and other indicators varied mildly within 1.0% (Figure 2-4-2-2).

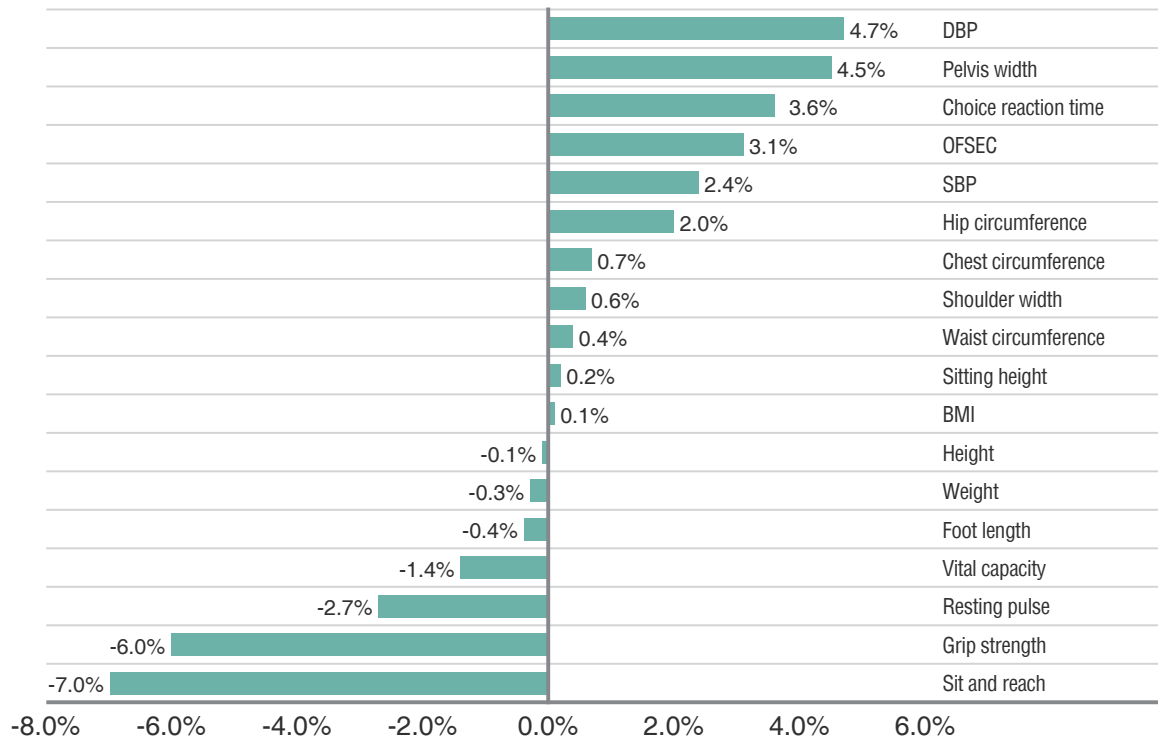

Figure 2-4-2-1 Comparison of study indicators in male seniors aged 60~69 between 2020 and 2015

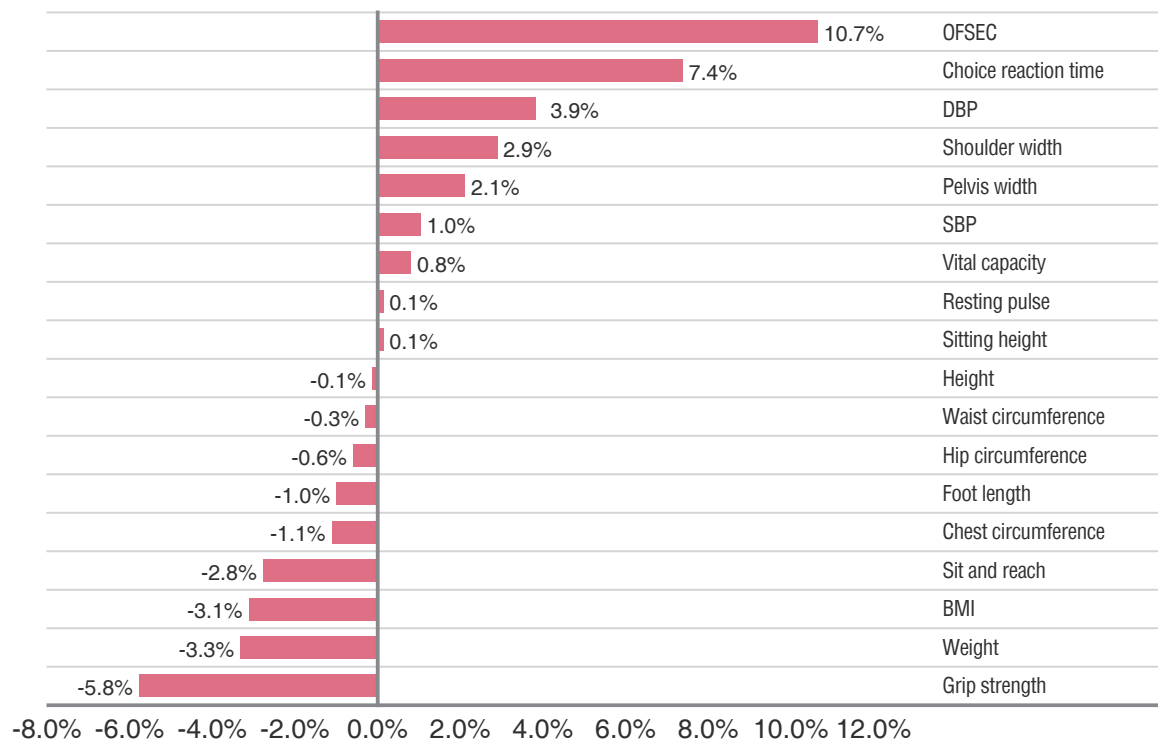

Figure 2-4-2-2 Comparison of study indicators in female seniors aged 60~69 between 2020 and 2015

2. Comparison of Seniors by Age

2.1 Comparison of Anthropometric Measurements

2.1.1 Length Indicators

Both the 2015 and 2020 studies showed that the average height of male and female seniors declined with advancing age. The average height of male seniors aged 60~64 and female seniors 65~69 was higher in 2020 than in 2015, while all other age groups had lower average height in 2020 than in 2015. No significant difference was observed in all age groups (Table 2-4-2-11).

The average sitting height of male and female seniors decreased with advancing age. The average sitting height of seniors in all age groups were higher in 2020 than in 2015, except for a decrease of 0.4cm recorded in the aged 60~64 group in females, but the difference was not significant across all age groups (Table 2-4-2-12).

The average foot length of male and female seniors was generally shorter in 2020 than 2015, except for male seniors aged 65~69 which remained unchanged. A decrease of 0.3cm was recorded in the aged 60~64 group of females, which was statistically significant ($P < 0.05$) (Table 2-4-2-13).

Table 2-4-2-11 Comparison of average height in male and female seniors in each age group between 2020 and 2015(cm)

Age group	Male			Female		
	2020	2015	Difference	2020	2015	Difference
60~64 years	166.5	166.3	0.2	154.3	154.9	-0.6
65~69 years	165.7	166.1	-0.4	154.1	153.7	0.4

Table 2-4-2-12 Comparison of average sitting height in male and female seniors in each age group between 2020 and 2015 (cm)

Age group	Male			Female		
	2020	2015	Difference	2020	2015	Difference
60~64 years	89.5	89.5	0.0	83.6	84.0	-0.4
65~69 years	89.4	89.1	0.3	83.3	82.8	0.5

Table 2-4-2-13 Comparison of average foot length in male and female seniors in each age group between 2020 and 2015 (cm)

Age group	Male			Female		
	2020	2015	Difference	2020	2015	Difference
60~64 years	24.7	24.8	-0.1	22.6	22.9	-0.3*
65~69 years	24.6	24.6	0.0	22.6	22.8	-0.2

2.1.2 Weight and BMI

Both the 2020 and 2015 studies suggested that as age increased, the average weight decreased in male seniors while increased in female seniors. However, the average weight of males and females were generally lower in 2020 than in 2015, with no significant difference in all age groups (Table 2-4-2-14).

The average BMI of male seniors was higher in 2020 than in 2015, whereas that of female seniors was lower in 2020 than in 2015. No significant difference was found in all age groups (Table 2-4-2-15).

Table 2-4-2-14 Comparison of average weight in male and female seniors in each age group between 2020 and 2015 (kg)

Age group	Male			Female		
	2020	2015	Difference	2020	2015	Difference
60~64 years	65.5	65.6	-0.1	54.6	57.8	-3.2
65~69 years	64.4	64.7	-0.3	56.6	56.9	-0.3

Table 2-4-2-15 Comparison of average BMI in male and female seniors in each age group between 2020 and 2015

Age group	Male			Female		
	2020	2015	Difference	2020	2015	Difference
60~64 years	23.8	23.7	0.1	22.9	24.1	-1.2
65~69 years	23.4	23.4	0.0	23.8	24.1	-0.3

Based on the BMI classification of underweight, normal weight, overweight and obesity, the comparison between 2020 and 2015 demonstrated that the prevalence of overweight among male seniors had decreased by 1.5%, and the prevalence of obesity had increased by 0.2%. For female seniors, those with normal weight had increased significantly by 13.1% ($P < 0.05$), and the prevalence of overweight had decreased by 11.1% ($P < 0.05$) (Table 2-4-2-16).

Table 2-4-2-16 Comparison of weight status in male and female seniors between 2020 and 2015 (%)

Gender	Year	Underweight	Normal weight	Overweight	Obesity
Male	2020	3.9%	55.6%	34.8%	5.7%
	2015	4.0%	54.2%	36.3%	5.5%
	2020-2015	-0.1%	1.4%	-1.5%	0.2%
Female	2020	3.6%	58.0%	31.5%	6.8%
	2015	2.7%	44.9%	42.6%	9.8%
	2020-2015	0.9%	13.1%*	-11.1%*	-3.0%

2.1.3 Circumference Indicators

Based on the results of the two studies, the average chest circumference of male seniors in each age group was higher in 2020 than in 2015, whereas that of female seniors was lower in 2020 than in 2015. A decrease of 1.3cm was recorded in the aged 60~64 group of females, with statistical significance ($P<0.05$) (Table 2-4-2-17).

The average waist circumference of male seniors aged 60~64 was higher in 2020 than in 2015, whereas that of male seniors aged 65~69 was lower in 2020 than in 2015, with no significant difference. The average waist circumference of female seniors aged 60~64 was lower in 2020 than in 2015, which differed significantly ($P<0.05$), and the average waist circumference of female seniors aged 65~69 was higher in 2020 than in 2015, which differed significantly ($P<0.05$) (Table 2-4-2-18).

The average hip circumference of male seniors was significantly higher in 2020 than in 2015 ($P<0.05$). The average hip circumference of female seniors aged 60~64 was lower in 2020 than in 2015, with statistical significance ($P<0.05$), and that of females aged 65~69 was higher in 2020 than in 2015, with no significant difference (Table 2-4-2-19).

Table 2-4-2-17 Comparison of average chest circumference in male and female seniors in each age group between 2020 and 2015 (cm)

Age group	Male			Female		
	2020	2015	Difference	2020	2015	Difference
60~64 years	92.3	91.8	0.5	87.6	88.9	-1.3*
65~69 years	92.5	91.7	0.8	88.5	89.1	-0.6

Table 2-4-2-18 Comparison of average waist circumference in male and female seniors in each age group between 2020 and 2015 (cm)

Age group	Male			Female		
	2020	2015	Difference	2020	2015	Difference
60~64 years	86.1	85.4	0.7	81.4	83.1	-1.7*
65~69 years	86.4	86.5	-0.1	84.7	83.2	1.5*

Table 2-4-2-19 Comparison of average hip circumference in male and female seniors in each age group between 2020 and 2015 (cm)

Age group	Male			Female		
	2020	2015	Difference	2020	2015	Difference
60~64 years	93.4	91.8	1.6*	93.1	94.5	-1.4*
65~69 years	93.0	91.0	2.0*	94.5	94.2	0.3

The average WHR of seniors was higher in 2020 than 2015 among all age groups, except for an increase found in the aged 65~69 group in females. The average WHR of male and female seniors aged 65~69 differed significantly in 2020 compared with that in 2015 ($P<0.05$) (Table 2-4-2-20).

Table 2-4-2-20 Comparison of average WHR in male and female seniors in each age group between 2020 and 2015

Age group	Male			Female		
	2020	2015	Difference	2020	2015	Difference
60~64 years	0.921	0.930	-0.009	0.873	0.879	-0.006
65~69 years	0.927	0.949	-0.022*	0.895	0.882	0.013*

2.1.4 Width Indicators

The results of the two studies revealed that the average shoulder width of seniors was higher in 2020 than in 2015, and the difference was statistically significant in all age groups in females ($P < 0.05$) (Table 2-4-2-21).

The average pelvis width of seniors was higher in 2020 than 2015 in all age groups except for females aged 60~64. The difference was statistically significant among all other age groups ($P < 0.05$) (Table 2-4-2-22).

Table 2-4-2-21 Comparison of average shoulder width in male and female seniors in each age group between 2020 and 2015(cm)

Age group	Male			Female		
	2020	2015	Difference	2020	2015	Difference
60~64 years	38.5	38.4	0.1	34.8	34.0	0.8*
65~69 years	38.3	37.9	0.4	34.8	33.6	1.2*

Table 2-4-2-22 Comparison of average pelvis width in male and female seniors in each age group between 2020 and 2015 (cm)

Age group	Male			Female		
	2020	2015	Difference	2020	2015	Difference
60~64 years	29.6	27.8	1.8*	28.5	28.2	0.3
65~69 years	28.5	28.0	0.5*	28.9	27.9	1.0*

2.1.5 Body Composition

In 2020, body fat percentage was directly measured using bioelectrical impedance analysis. While in 2015, body fat percentage was derived from the computed formula after the measurement of skinfold thickness. Therefore, the average values in the two studies cannot be compared in principle. The comparison results shown below were for reference only. The results showed that the body fat percentage of seniors was higher in 2020 than 2015, with statistical significance ($P < 0.05$), but their average weight was lower in 2020 than in 2015, reflecting that their muscle mass among body weight had decreased in 2020 (Table 2-4-2-23).

In terms of lean body mass, the average lean body mass of male and female seniors in each age group decreased in 2020 compared with that in 2015, which differed statistically significant ($P < 0.05$). The largest decrease was recorded in males aged 60~64 (Table 2-4-2-24).

Table 2-4-2-23 Comparison of average body fat percentage in male and female seniors in each age group between 2020 and 2015 (%)

Age group	Male			Female		
	2020	2015	Difference	2020	2015	Difference
60~64 years	22.2	17.9	4.3*	30.5	29.3	1.2*
65~69 years	21.8	18.0	3.8*	32.2	29.0	3.2*

Table 2-4-2-24 Comparison of average lean body mass in male and female seniors in each age group between 2020 and 2015 (kg)

Age group	Male			Female		
	2020	2015	Difference	2020	2015	Difference
60~64 years	50.6	53.7	-3.1*	37.6	40.6	-3.0*
65~69 years	50.0	52.7	-2.7*	38.1	40.0	-1.9*

2.2 Comparison of Physiological Function

2.2.1 Resting Pulse

Comparison of the results in the two studies showed that the average resting pulse of male seniors in 2020 was higher in the aged 60~64 group but lower in the aged 65~69 group compared with that in 2015. For female seniors, the average resting pulse was lower in 2020 than 2015 in the aged 60~64 group, and remained constant in the aged 65~69 group. No significant difference was seen in all age groups (Table 2-4-2-25).

Table 2-4-2-25 Comparison of average resting pulse in male and female seniors in each age group between 2020 and 2015 (bpm)

Age group	Male			Female		
	2020	2015	Difference	2020	2015	Difference
60~64 years	73.9	73.3	0.6	72.8	72.9	-0.1
65~69 years	71.8	74.8	-3.0	73.2	73.2	0.0

2.2.2 Blood Pressure

According to the two studies, the average SBP of seniors increased in 2020 compared with that in 2015 in all age groups except for a decreased recorded in females aged 60~64. Statistical significance was observed in all age groups ($P < 0.05$) (Table 2-4-2-26).

Table 2-4-2-26 Comparison of average SBP in male and female seniors in each age group between 2020 and 2015 (mmHg)

Age group	Male			Female		
	2020	2015	Difference	2020	2015	Difference
60~64 years	136.2	132.8	3.4*	130.7	131.4	-0.7
65~69 years	137.4	133.9	3.5*	137.5	130.6	6.9*

In 2020, the average DBP of male seniors in each age group increased compared with that in 2015, with statistical significance found in the aged 60~64 group ($P < 0.05$). For female seniors, the average DBP was higher in 2020 than 2015 in the aged 65~69 group, which was statistically significant ($P < 0.05$). The average DBP was lower in 2020 than 2015 in females aged 60~64, with no statistical significance (Table 2-4-2-27).

Table 2-4-2-27 Comparison of average DBP in male and female seniors in each age group between 2020 and 2015 (mmHg)

Age group	Male			Female		
	2020	2015	Difference	2020	2015	Difference
60~64 years	78.0	75.8	2.2*	73.5	74.2	-0.7
65~69 years	76.2	74.0	2.2	75.3	71.6	3.7*

The two studies showed that the average pressure difference of seniors in each age group showed an upward trend in 2020 compared with that in 2015. The largest increase was observed in females aged 65~69, which had statistical significance ($P < 0.05$) (Table 2-4-2-28).

Table 2-4-2-28 Comparison of average pressure difference in male and female seniors in each age group between 2020 and 2015 (mmHg)

Age group	Male			Female		
	2020	2015	Difference	2020	2015	Difference
60~64 years	58.2	57.0	1.2	57.5	57.2	0.3
65~69 years	61.2	59.9	1.3	62.7	59.1	3.6*

2.2.3 Vital Capacity

As indicated in the two studies, the average vital capacity of male seniors in all age groups was lower in 2020 than in 2015, whereas that of female seniors in all age groups was higher in 2020 than in 2015. The difference in each age group was not significant (Table 2-4-2-29).

Table 2-4-2-29 Comparison of average vital capacity in male and female seniors in each age group between 2020 and 2015(ml)

Age group	Male			Female		
	2020	2015	Difference	2020	2015	Difference
60~64 years	3006.4	3043.7	-37.3	1982.5	1966.3	16.2
65~69 years	2772.9	2816.6	-43.7	1829.8	1816.8	13.0

In terms of vital capacity/weight, the two studies demonstrated that there was a 2.2 ml/kg increase in females aged 60~64 in 2020 compared with that in 2015 ($P < 0.05$), and that of males had decreased in 2020 compared to 2015. The difference was not significant in all age groups (Table 2-4-2-30).

Table 2-4-2-30 Comparison of average vital capacity/weight in male and female seniors in each age group between 2020 and 2015 (ml/kg)

Age group	Male			Female		
	2020	2015	Difference	2020	2015	Difference
60~64 years	46.3	47.0	-0.7	36.9	34.7	2.2*
65~69 years	43.4	44.0	-0.6	33.1	32.6	0.5

2.3 Comparison of Physical Fitness

2.3.1 Strength

The two studies revealed that male and female seniors had greater average grip strength in all age groups in 2020 than in 2015, and the difference in each age group was statistically significant ($P < 0.05$) (Table 2-4-2-31).

Tabela 2-4-2-31 Comparison of average grip strength in male and female seniors in each age group between 2020 and 2015 (kg)

Age group	Male			Female		
	2020	2015	Difference	2020	2015	Difference
60~64 years	36.4	37.7	-1.3*	21.2	23.0	-1.8*
65~69 years	33.6	37.0	-3.4*	20.4	21.1	-0.7*

2.3.2 Flexibility

The two studies showed that the average sit and reach of male and female seniors in all age groups was lower in 2020 than 2015, with significant difference in all age groups ($P < 0.05$) (Table 2-4-2-32).

Table 2-4-2-32 Comparison of average sit and reach in male and female seniors in each age group between 2020 and 2015 (cm)

Age group	Male			Female		
	2020	2015	Difference	2020	2015	Difference
60~64 years	0.6	0.9	-0.3*	6.7	7.8	-1.1*
65~69 years	-2.9	0.9	-3.8*	6.2	6.6	-0.4*

2.3.3 Reaction

According to the results of the two studies, the average choice reaction time of male and female seniors in each age group was lower in 2020 than in 2015, with statistical significance found in all age groups ($P < 0.05$), which indicated that the reaction of seniors had improved in 2020 (Table 2-4-2-33).

Table 2-4-2-33 Comparison of average choice reaction time in male and female seniors in each age group between 2020 and 2015 (sec)

Age group	Male			Female		
	2020	2015	Difference	2020	2015	Difference
60~64 years	0.48	0.50	-0.02*	0.52	0.56	-0.04*
65~69 years	0.51	0.53	-0.02*	0.55	0.60	-0.05*

2.3.4 Balance

The average OFSEC time of male and female seniors in all age groups was longer in 2020 than in 2015. Except for males aged 60~64, the difference was statistically significant in all age groups ($P < 0.05$) (Table 2-4-2-34).

Table 2-4-2-34 Comparison of average OFSEC time in male and female seniors in each age group between 2020 and 2015 (sec)

Age group	Male			Female		
	2020	2015	Difference	2020	2015	Difference
60~64 years	12.4	12.2	0.2	9.8	8.4	1.4*
65~69 years	8.6	8.2	0.4*	8.2	7.2	1.0*

(III) Summary

1. Summary of 2020 Results on Physical Fitness Study of Seniors

Nearly 80% of senior subjects aged 60~79 exercise for 30~119 minutes each time, and almost 50% of senior subjects exercise each time with slightly increased breathing, heart rate and sweating. More than half of the seniors walked or bicycled for 30 minutes to two hours daily, the majority of seniors sit for an average of 3~6 hours daily, and nearly 80% of them have an average of 6~9 hours sleeping time daily. The anthropometric indicators of seniors remained fairly stable with advancing age. Indicators including height, weight, chest and waist circumferences were higher in males than in females, while hip circumference was higher in females than in males. Vital capacity had decreased considerably with advancing age, and males had a higher average vital capacity than females. Physical fitness of seniors tended to decline with advancing age. Males had better strength, reaction and balance abilities than females, while females had better flexibility than males.

2. Comparison of 2020 and 2015 Physical Fitness Study Results of Seniors

Compared with the results in 2015, the proportion of seniors who sleep for an average of less than six hours daily had decreased dramatically in 2020.

In terms of exercise frequency (times per week), the proportion of male and female seniors aged 60~69 who participated in physical exercise increased by 7.5% and 4.8%, respectively in 2020 compared with 2015. The proportion of male and female seniors aged 60~69 who exercise for three times or more per week had increased by 18.0% and 8.2% in 2020, respectively. The proportion of frequent exercisers in seniors aged 60~69 had increased by 11.6% in 2020 compared to 38.6% in 2015.

Comparison of the results in 2020 and 2015 showed that indicators including height, weight and foot length of male seniors had slightly decreased, but other indicators had all increased. Indicators including shoulder width, pelvis width and sitting height of female seniors had increased slightly, but all other indicators of female seniors had decreased.

In terms of physiological function and physical fitness of seniors, vital capacity, resting pulse, grip strength, and sit and reach of males had all decreased, while their blood pressure, reaction and balance abilities had improved. Grip strength and sit and reach of females had decreased, while vital capacity, blood pressure, reaction and balance had all improved.

V. Summary of Comparison of 2020 and 2015 Results on the Physical Fitness Study

To sum up the results that have been stated so far, in combination with the current physical fitness status of Macao residents and the comparison with 2015 described in the *Briefing of 2020 Physical Fitness Study of Macao Residents*, the overall fitness status of Macao residents had slightly improved in 2020 compared with that in 2015. More specifically, the overall fitness level of young children, children and adolescents (students) had declined, whereas the fitness level of adults and seniors had increased in general.



Part III
Statistics

I. Young Children

1. Basic Information of the Subjects

Table 3-1-1-1 Distribution of sampling sites (kindergartens)

Area	Sampling site (kindergarten)	M		F		Total	
		Subjects (n)	Percentage (%)	Subjects (n)	Percentage (%)	Subjects (n)	Percentage (%)
Northern area	Keang Peng School (kindergarten)	105	15.7	92	20.7	197	17.7
	Hou Kong Middle School (kindergarten: including affiliated kindergarten and primary school)	120	17.9	89	20.0	209	18.8
Central area	Pui Ching Middle School (kindergarten)	103	15.4	88	19.8	191	17.2
	Chan Sui Ki Perpetual Help College (branch school)	150	22.4	50	11.3	200	18.0
Southern area	Pooi To Middle School (kindergarten: including branch school of Praia Grande and Taipa kindergarten)	109	16.3	67	15.1	176	15.8
	Estrela do Mar School (kindergarten)	82	12.3	58	13.1	140	12.6
Total		669	100	444	100	1113	100

Table 3-1-1-2 Residential distribution of subjects (%)

Gender	Parish	Keang Peng School (kindergarten)	Hou Kong Middle School (kindergarten)	Pui Ching Middle School (kindergarten)	Chan Sui Ki Perpetual Help College (branch school)	Pooi To Middle School (kindergarten)	Estrela do Mar School (kindergarten)
M	São Francisco Xavier	0.0	0.8	2.0	2.0	4.7	1.2
	Nossa Senhora do Carmo	1.9	2.5	16.3	10.1	36.8	1.2
	São Lourenço	1.9	1.7	4.1	0.7	7.5	82.9
	Sé Catedral	2.9	4.3	7.2	9.4	23.6	4.9
	Santo António	15.6	56.8	39.8	26.2	8.5	0.0
	São Lázaro	3.9	3.4	13.3	14.0	5.7	1.2
	Nossa Senhora de Fátima	73.8	30.5	17.3	37.6	13.2	8.5
F	São Francisco Xavier	0.0	1.1	2.3	2.0	6.1	1.7
	Nossa Senhora do Carmo	2.2	1.1	15.1	14.0	47.0	0.0
	São Lourenço	0.0	1.1	3.5	8.0	15.1	85.7
	Sé Catedral	2.2	5.7	11.6	8.0	13.6	3.6
	Santo António	20.9	50.1	41.9	24.0	6.1	1.8
	São Lázaro	7.7	11.4	7.0	2.0	7.6	1.8
	Nossa Senhora de Fátima	67.0	29.5	18.6	42.0	4.5	5.4

Table 3-1-1-3 The proportion of birthplaces of young children in different age groups (%)

Gender	Birthplace	Age 3	Age 4	Age 5	Total*
M	Mainland China	1.3	0.0	0.0	0.5
	Macao	90.0	94.9	95.7	93.4
	Hong Kong	6.5	4.1	3.9	4.9
	Others	2.2	1.0	0.4	1.2
F	Mainland China	0.7	1.6	0.6	0.9
	Macao	94.4	93.8	92.1	93.4
	Hong Kong	4.9	2.3	5.5	4.3
	Others	0.0	2.3	1.8	1.4

*Note: 6-year age group is excluded from statistical analysis due to insufficient sample size, and it applies to subsequent tables below.

Table 3-1-1-4 Kindergarten attendance of young children in different age groups (%)

Gender	Kindergarten attendance	Age 3	Age 4	Age 5	Total
M	No	2.2	0.5	0.4	1.1
	Half day	2.6	0.0	0.4	1.1
	Full day	95.2	99.5	99.2	97.8
	Boarding	0.0	0.0	0.0	0.0
F	No	2.1	0.8	0.6	1.2
	Half day	2.1	0.0	0.6	0.9
	Full day	95.8	99.2	98.8	97.9
	Boarding	0.0	0.0	0.0	0.0

Table 3-1-1-5 The proportion of different caregivers at home in young children (%)

Gender	Caregiver	Age 3	Age 4	Age 5	Total
M	Parents	64.2	68.1	65.2	65.7
	Senior family members	19.0	18.0	20.9	19.4
	Babysitters (domestic helpers)	16.4	13.9	13.5	14.6
	Others	0.4	0.0	0.4	0.3
F	Parents	60.8	57.4	63.6	60.9
	Senior family members	24.5	28.6	20.6	24.2
	Babysitters (domestic helpers)	14.7	14.0	15.8	14.9
	Others	0.0	0.0	0.0	0.0

2. Lifestyle

Table 3-1-2-1 The proportion of different gestational ages in young children (%)

Gender	Age group (years)	Subjects (n)	Early-term	Full-term	Late-term
M	3	232	12.1	84.9	3.0
	4	194	13.4	86.1	0.5
	5	230	13.5	83.5	3.0
F	3	143	9.8	88.8	1.4
	4	129	7.0	88.4	4.6
	5	165	8.5	88.5	3.0
Total		1093	11.2	86.3	2.6

Table 3-1-2-2 The birth weight of young children in different age groups (kg)

Gender	Age group (years)	Subjects (n)	Mean	SD	P ₃	P ₁₀	P ₂₅	P ₅₀	P ₇₅	P ₉₀	P ₉₇
M	3	201	3.3	0.65	2.3	2.7	3.0	3.2	3.5	4.0	4.2
	4	162	3.3	0.69	2.4	2.6	2.9	3.2	3.5	3.8	4.3
	5	180	3.4	1.03	2.1	2.6	3.0	3.2	3.6	4.0	7.1
F	3	119	3.3	0.82	2.2	2.6	2.8	3.1	3.4	3.7	6.3
	4	117	3.3	0.99	2.3	2.5	2.8	3.1	3.4	3.8	6.9
	5	136	3.3	1.01	2.3	2.5	2.8	3.2	3.5	3.7	7.3

Table 3-1-2-3 The birth length of young children in different age groups (cm)

Gender	Age group (years)	Subjects (n)	Mean	SD	P ₃	P ₁₀	P ₂₅	P ₅₀	P ₇₅	P ₉₀	P ₉₇
M	3	193	49.2	2.84	44.0	47.0	48.0	49.5	50.9	52.0	53.0
	4	152	49.1	2.81	42.5	46.5	48.0	49.5	50.6	52.0	53.0
	5	163	49.1	3.16	42.2	46.0	48.0	49.5	51.0	52.0	54.0
F	3	116	47.9	4.05	33.2	46.0	47.0	48.0	49.5	51.0	53.0
	4	104	48.5	2.66	41.1	46.0	48.0	49.0	49.5	51.0	53.0
	5	126	48.8	3.35	40.8	45.8	47.3	49.5	50.0	51.0	56.4

Table 3-1-2-4 The proportion of different feeding patterns within 4 months after birth in young children (%)

Gender	Age group (years)	Subjects (n)	Breast feeding	Formula feeding	Mixed feeding
M	3	232	46.1	16.8	37.1
	4	194	40.2	21.6	38.1
	5	230	37.4	24.8	37.8
F	3	143	37.8	21.0	41.3
	4	129	35.7	17.8	46.5
	5	165	43.6	23.0	33.3
Total		1093	40.6	20.9	38.5

Table 3-1-2-5 The proportion of different daily nap time in young children (%)

Gender	Age group (years)	Subjects (n)	No nap	Less than 2 hours	2~4 hours	4 hours or more	
School days	M	3	232	3.9	64.6	31.0	0.5
		4	194	2.6	68.1	29.3	0.0
		5	230	11.2	68.3	20.1	0.4
	F	3	143	3.5	69.3	26.5	0.7
		4	129	3.1	71.3	25.6	0.0
		5	165	6.7	73.9	18.2	1.2
Total		1093	5.4	68.8	25.1	0.7	
Rest days	M	3	232	7.8	24.1	67.7	0.4
		4	194	15.5	26.3	58.2	0.0
		5	230	31.7	36.1	32.2	0.0
	F	3	143	8.4	28.7	62.9	0.0
		4	129	18.6	35.7	44.9	0.8
		5	165	24.8	38.8	35.8	0.6
Total		1093	18.1	31.2	50.4	0.3	

Table 3-1-2-6 The proportion of different daily sleep time at night in young children (%)

	Gender	Age group (years)	Subjects (n)	Less than 8 hours	8~11 hours	11 hours or more
School days	M	3	232	0.0	97.8	2.2
		4	194	0.5	96.9	2.6
		5	230	0.9	96.1	3.0
	F	3	143	0.0	94.4	5.6
		4	129	0.0	95.3	4.7
		5	165	0.6	96.4	3.0
Total			1093	0.4	96.3	3.3
Rest days	M	3	232	1.3	86.2	12.5
		4	194	0.5	88.7	10.8
		5	230	0.9	85.2	13.9
	F	3	143	0.0	85.3	14.7
		4	129	0.0	84.5	15.5
		5	165	0.6	86.7	12.7
Total			1093	0.6	86.2	13.2

Table 3-1-2-7 The proportion of different time spending on TV, video and video games per day in young children (%)

	Gender	Age group (years)	Subjects (n)	Basically none	Less than 1 hour	1~2 hours	2 hours or more
School days	M	3	232	3.9	68.9	21.6	5.6
		4	194	7.2	53.6	28.4	10.8
		5	230	8.7	56.5	24.8	10.0
	F	3	143	7.7	65.7	19.6	7.0
		4	129	5.4	65.1	22.5	7.0
		5	165	4.2	65.5	22.4	7.9
Total			1093	6.2	62.2	23.4	8.1
Rest days	M	3	232	2.2	50.0	32.8	15.0
		4	194	0.5	40.7	32.5	26.3
		5	230	1.7	37.9	40.0	20.4
	F	3	143	2.1	47.6	32.2	18.1
		4	129	0.7	50.4	32.6	16.3
		5	165	0.6	43.6	35.8	20.0
Total			1093	1.4	44.5	34.6	19.5

Table 3-1-2-8 The participation rate of young children in different physical

Subjects (n)	Walking	Running	Gymnastics	Dancing	Basketball	Football	Cycling	Swimming	Roller skating	Others	Sports games	None
M	432	355	45	60	69	112	306	207	35	42	167	53
F	295	204	36	204	14	12	156	123	21	31	102	30
Total	727	559	81	264	83	124	462	330	56	73	269	83
%												
M	65.9%	54.1%	6.9%	9.1%	10.5%	17.1%	46.6%	31.6%	5.3%	6.4%	25.5%	8.1%
F	67.5%	46.7%	8.2%	46.7%	3.2%	2.1%	35.7%	28.1%	4.8%	7.1%	23.3%	6.9%
Total	66.5%	51.1%	7.4%	24.2%	7.6%	11.3%	42.3%	30.2%	5.1%	6.9%	24.6%	7.6%

Table 3-1-2-9 The proportion of different time spending on physical exercises in young children (%)

	Gender	Age group (years)	Subjects (n)	Less than 30 minutes	30 minutes~1 hour	1~2 hours	2 hours or more
School days	M	3	232	31.9	47.0	15.1	6.0
		4	194	33.0	46.9	13.9	6.2
		5	230	37.7	41.7	12.3	8.3
	F	3	143	24.5	44.1	23.8	7.6
		4	129	25.6	47.3	20.9	6.2
		5	165	32.1	48.5	12.7	6.7
	Total		1093	31.7	45.7	15.8	6.8
Rest days	M	3	232	3.0	28.4	47.8	20.8
		4	194	5.7	27.3	45.4	21.6
		5	230	4.8	27.8	44.8	22.6
	F	3	143	6.3	25.9	46.9	20.9
		4	129	7.8	28.7	37.8	25.7
		5	165	5.5	30.3	39.4	24.8
	Total		1093	5.2	28.0	44.2	22.6

Table 3-1-2-10 The participation rate of young children in training classes related to physical exercise (%)

Gender	Age group (years)	Subjects (n)	None	Occasional participation	Active participation
M	3	232	66.8	22.8	10.4
	4	194	49.5	41.2	9.3
	5	230	29.1	48.7	22.2
F	3	143	58.0	28.7	13.3
	4	129	38.0	29.5	32.4
	5	165	22.4	41.8	35.8
Total		1093	44.6	35.9	19.5

Table 3-1-2-11 The proportion of different weekly time spending on training classes related to physical exercise in young children (%)

Gender	Age group (years)	No. of subjects participated in training class currently	Less than 1 hour	1-2 hours	2 hours or more
M	3	44	36.4	59.1	4.5
	4	66	37.9	53.0	9.1
	5	120	30.0	61.7	8.3
F	3	36	33.3	61.1	5.6
	4	67	35.8	56.7	7.5
	5	112	25.0	65.2	9.8
Total		445	31.7	60.2	8.1

Table 3-1-2-12 The proportion of young children with diagnosed diseases (%)

Gender	Age group (years)	Subjects (n)	Yes	No
M	3	232	47.0	53.0
	4	194	46.9	53.1
	5	230	45.7	54.3
F	3	143	37.1	62.9
	4	129	45.7	54.3
	5	165	44.2	55.8
Total		1093	44.8	55.2

Table 3-1-2-13 Percentage of various diseases in young children (%)

Gender	Age group (years)	No. of subjects diagnosed with disease	Acute bronchitis	Pneumonia	Allergic rhinitis	Diarrhea	Gastroenteritis	HFMD	Eczema	Otitis media	Urinary tract infection	Others
M	3	109	32.1	21.9	9.1	16.6	20.2	33.8	34.9	4.7	8.3	0.6
	4	91	38.4	22.0	6.6	9.8	23.0	49.5	17.5	6.6	7.7	8.7
	5	105	33.3	12.5	15.3	6.6	25.6	19.0	12.5	16.2	5.0	4.8
F	3	53	30.2	26.4	7.5	5.7	26.4	30.2	34.0	0.0	0.0	13.2
	4	59	33.9	20.4	10.3	6.8	25.4	33.9	25.4	13.6	5.0	10.3
	5	73	46.6	13.8	9.5	4.1	23.3	31.4	19.9	9.5	2.7	8.1
Total		490	35.7	19.0	10.0	9.0	23.6	41.3	26.8	8.8	5.5	8.0

Table 3-1-2-14 The proportion of young children with and without daily tooth brushing habit (%)

Gender	Age group (years)	Subjects (n)	Yes	No
M	3	232	90.5	9.5
	4	194	89.2	10.8
	5	230	92.6	7.4
F	3	143	91.6	8.4
	4	129	90.7	9.3
	5	165	90.9	9.1
Total		1093	90.9	9.1

Table 3-1-2-15 The proportion of young children with and without daily tooth flossing habit (%)

Gender	Age group (years)	Subjects (n)	Yes	No
M	3	232	6.5	93.5
	4	194	9.3	90.7
	5	230	12.6	87.4
F	3	143	8.4	91.6
	4	129	10.1	89.9
	5	165	7.9	92.1
Total		1093	9.1	90.9

Table 3-1-2-16 The proportion of young children who had and had not visited clinics for dental examination in the past 12 months (%)

Gender	Age group (years)	Subjects (n)	Yes	No
M	3	232	17.2	82.8
	4	194	26.8	73.2
	5	230	38.7	61.3
F	3	143	14.7	85.3
	4	129	24.8	75.2
	5	165	41.8	58.2
Total		1093	27.7	72.3

Table 3-1-2-17 The proportion of young children with and without dental caries (%)

Gender	Age group (years)	Subjects (n)	Yes	No	Don't know
M	3	232	8.6	51.3	40.1
	4	194	23.2	38.7	38.1
	5	230	28.3	37.0	34.8
F	3	143	10.5	49.7	39.9
	4	129	17.8	41.9	40.3
	5	165	32.7	37.6	29.7
Total		1093	20.3	42.6	37.1

Table 3-1-2-18 The proportion of young children with dental caries who had and did not have dental treatment at clinics (%)

Gender	Age group (years)	Subjects (n)	No. of subjects with dental caries	Yes	No
M	3	232	20	60.0	40.0
	4	194	45	57.8	42.2
	5	230	65	64.6	35.4
F	3	143	15	40.0	60.0
	4	129	23	78.3	21.7
	5	165	54	75.9	24.1
Total		1093	222	65.3	34.7

3. Anthropometric Measurements

Table 3-1-3-1 Height (cm)

Gender	Age group (years)	n	Mean	SD	P ₃	P ₁₀	P ₂₅	P ₅₀	P ₇₅	P ₉₀	P ₉₇
M	3	232	98.7	4.33	90.3	93.1	95.6	98.8	101.5	104.6	107.5
	4	194	105.5	4.79	96.4	99.5	102.1	105.3	108.5	112.2	115.4
	5	230	111.9	4.52	103.9	105.4	109.0	111.8	115.0	118.0	120.6
F	3	143	97.8	3.96	90.4	92.3	95.2	97.7	100.5	102.5	105.5
	4	129	105.3	5.28	96.6	99.7	101.5	104.4	108.3	112.4	117.6
	5	165	111.3	5.06	102.9	105.4	108.1	111.5	114.9	117.0	119.6

Table 3-1-3-2 Sitting height (cm)

Gender	Age group (years)	n	Mean	SD	P ₃	P ₁₀	P ₂₅	P ₅₀	P ₇₅	P ₉₀	P ₉₇
M	3	230	56.5	2.68	51.2	52.8	54.9	56.5	58.1	60.0	61.9
	4	194	59.7	2.64	55.0	56.5	57.9	59.6	61.3	63.2	65.1
	5	229	62.5	2.39	58.0	59.3	60.8	62.6	64.0	65.6	67.1
F	3	142	56.0	2.37	51.6	52.6	54.2	56.1	57.7	59.1	60.1
	4	127	59.4	2.92	55.2	56.3	57.3	58.8	61.0	63.5	66.4
	5	163	62.1	2.82	57.2	58.6	59.9	62.1	63.9	65.8	67.7

Table 3-1-3-3 Foot length (cm)

Gender	Age group (years)	n	Mean	SD	P ₃	P ₁₀	P ₂₅	P ₅₀	P ₇₅	P ₉₀	P ₉₇
M	3	223	15.5	0.83	13.8	14.4	15.0	15.5	16.1	16.6	17.0
	4	194	16.4	0.92	14.7	15.3	15.8	16.4	17.0	17.7	18.1
	5	230	17.3	1.34	15.5	16.0	16.7	17.4	18.0	18.6	19.4
F	3	143	15.5	1.29	14.0	14.3	14.8	15.3	15.9	16.4	17.1
	4	129	16.4	1.00	14.8	15.2	15.7	16.4	17.0	17.6	19.0
	5	165	17.1	0.88	15.4	16.0	16.6	17.1	17.7	18.4	18.7

Table 3-1-3-4 Weight (kg)

Gender	Age group (years)	n	Mean	SD	P ₃	P ₁₀	P ₂₅	P ₅₀	P ₇₅	P ₉₀	P ₉₇
M	3	232	15.3	1.97	12.1	12.9	13.9	15.2	16.4	17.7	19.6
	4	194	17.1	2.43	13.1	14.5	14.4	16.7	18.2	20.0	23.3
	5	230	19.4	3.06	14.9	15.9	17.2	18.8	20.9	23.5	26.2
F	3	143	14.8	2.04	11.9	12.6	13.4	14.5	15.9	17.1	20.8
	4	129	16.9	2.53	13.3	14.1	15.1	16.3	18.5	20.2	23.2
	5	165	18.8	2.91	14.5	15.9	17.0	18.5	20.3	21.8	25.4

Table 3-1-3-5 BMI

Gender	Age group (years)	n	Mean	SD	P ₃	P ₁₀	P ₂₅	P ₅₀	P ₇₅	P ₉₀	P ₉₇
M	3	232	15.7	1.28	13.6	14.1	14.9	15.6	16.3	17.2	18.3
	4	194	15.3	1.35	13.2	13.9	14.5	15.1	15.9	17.0	17.7
	5	230	15.4	1.64	13.3	13.6	14.2	15.1	16.3	17.8	18.8
F	3	143	15.5	1.83	13.2	13.9	14.5	15.3	16.2	17.2	19.2
	4	129	15.2	1.37	13.3	13.7	14.1	15.0	16.1	17.1	18.4
	5	165	15.2	1.94	12.7	13.4	14.0	14.8	15.8	17.5	19.4

Table 3-1-3-6 Percentage of underweight, normal weight, overweight and obesity in Macao young children in 2020

Age group (years)	M					F				
	n	Under-weight	Normal weight	Over-weight	Obesity	n	Under-weight	Normal weight	Over-weight	Obesity
3	232	4.5%	80.8%	10.8%	3.9%	143	5.1%	83.0%	5.6%	6.3%
4	194	5.4%	80.1%	11.9%	2.6%	129	4.0%	85.9%	6.2%	3.9%
5	230	3.6%	78.6%	10.4%	7.4%	165	4.4%	83.4%	6.1%	6.1%
Total	656	4.3%	80.0%	11.0%	4.7%	437	4.3%	84.3%	5.9%	5.5%

Note: BMI classification of overweight and obesity is referred to the National Sample Standards; critical value of underweight is referred to IOTF standard.

Table 3-1-3-7 Chest circumference (cm)

Gender	Age group (years)	n	Mean	SD	P ₃	P ₁₀	P ₂₅	P ₅₀	P ₇₅	P ₉₀	P ₉₇
M	3	232	52.7	2.58	48.1	49.5	50.9	52.5	54.1	56.6	57.5
	4	194	53.9	2.86	49.9	50.7	52.0	53.5	55.5	57.4	60.1
	5	230	56.3	3.34	50.5	52.3	54.0	56.0	58.5	60.5	63.2
F	3	143	52.0	2.73	48.0	48.9	50.1	51.5	53.4	56.0	58.8
	4	129	53.2	2.90	48.8	49.8	51.3	53.0	54.7	57.0	59.7
	5	164	54.6	3.02	49.9	51.0	52.5	54.0	56.3	58.3	61.8

Table 3-1-3-8 Waist circumference (cm)

Gender	Age group (years)	n	Mean	SD	P ₃	P ₁₀	P ₂₅	P ₅₀	P ₇₅	P ₉₀	P ₉₇
M	3	232	48.6	3.44	43.1	44.8	46.3	48.0	50.7	52.8	56.7
	4	194	49.8	3.74	44.3	45.5	47.5	49.5	51.5	54.0	57.8
	5	229	51.6	4.55	44.8	46.6	48.5	50.9	53.7	57.8	61.9
F	3	143	48.4	3.70	42.8	44.3	45.8	48.0	50.5	53.3	56.5
	4	129	50.3	4.41	43.5	45.5	47.0	49.5	52.8	57.0	59.7
	5	164	50.8	4.06	44.6	46.2	48.0	50.3	52.8	56.1	59.5

Table 3-1-3-9 Hip circumference (cm)

Gender	Age group (years)	n	Mean	SD	P ₃	P ₁₀	P ₂₅	P ₅₀	P ₇₅	P ₉₀	P ₉₇
M	3	232	54.7	3.45	48.6	50.2	52.4	54.4	56.8	59.2	61.5
	4	194	57.3	3.79	51.0	53.0	54.6	57.0	59.7	62.5	65.8
	5	230	59.3	4.73	51.8	53.5	55.8	58.7	62.0	66.0	69.1
F	3	143	55.2	3.74	49.2	51.0	52.8	54.8	57.2	60.0	62.9
	4	129	58.7	3.99	51.9	53.5	55.6	58.3	61.2	64.0	67.9
	5	164	60.1	3.97	53.6	55.1	57.5	59.9	62.7	65.0	70.0

Table 3-1-3-10 Waist to Hip Ratio (WHR)

Gender	Age group (years)	n	Mean	SD	P ₃	P ₁₀	P ₂₅	P ₅₀	P ₇₅	P ₉₀	P ₉₇
M	3	232	0.966	0.040	0.888	0.908	0.943	0.965	0.992	1.012	1.043
	4	194	0.942	0.038	0.871	0.893	0.918	0.943	0.967	0.990	1.009
	5	229	0.953	0.046	0.870	0.901	0.922	0.946	0.978	1.007	1.069
F	3	143	0.944	0.046	0.867	0.888	0.918	0.943	0.966	0.997	1.046
	4	129	0.909	0.040	0.821	0.862	0.880	0.908	0.937	0.962	0.981
	5	164	0.909	0.039	0.833	0.869	0.884	0.907	0.930	0.962	0.988

Table 3-1-3-11 Shoulder width (cm)

Gender	Age group (years)	n	Mean	SD	P ₃	P ₁₀	P ₂₅	P ₅₀	P ₇₅	P ₉₀	P ₉₇
M	3	232	22.3	1.34	19.6	20.6	21.5	22.4	23.2	23.9	24.5
	4	192	23.4	1.34	21.1	21.9	22.5	23.3	24.2	25.1	25.8
	5	229	24.7	1.40	22.4	23.1	23.8	24.6	25.5	26.5	27.2
F	3	143	22.4	1.11	20.8	21.2	21.6	22.4	23.0	24.1	24.6
	4	128	23.5	1.42	21.3	21.7	22.7	23.4	24.3	25.1	26.3
	5	164	24.8	1.39	22.2	23.2	24.0	24.8	25.6	26.6	27.5

Table 3-1-3-12 Pelvis width (cm)

Gender	Age group (years)	n	Mean	SD	P ₃	P ₁₀	P ₂₅	P ₅₀	P ₇₅	P ₉₀	P ₉₇
M	3	232	17.0	1.17	15.0	15.5	16.3	17.0	17.7	18.3	19.5
	4	194	17.7	1.09	15.9	16.5	17.0	17.6	18.3	19.0	20.0
	5	229	18.6	1.24	16.3	17.1	17.8	18.4	19.4	20.1	21.1
F	3	143	17.1	1.15	14.9	15.7	16.4	17.1	17.8	18.5	19.5
	4	129	17.8	1.16	15.7	16.4	17.0	17.7	18.6	19.5	20.1
	5	165	18.8	1.31	16.3	17.1	18.0	18.6	19.5	20.4	21.1

Table 3-1-3-13 Body fat percentage (%)

Gender	Age group (years)	n	Mean	SD	P ₃	P ₁₀	P ₂₅	P ₅₀	P ₇₅	P ₉₀	P ₉₇
M	3	231	17.8	4.24	9.4	12.1	14.9	17.7	20.8	23.0	25.8
	4	194	17.1	4.32	9.3	11.5	14.3	16.8	20.0	22.5	25.9
	5	230	17.2	5.36	8.8	9.8	13.5	16.6	20.6	24.7	27.2
F	3	143	21.8	4.26	13.9	17.1	19.2	21.7	24.3	27.1	31.3
	4	129	21.3	4.78	12.2	15.8	18.3	21.2	24.3	27.7	30.6
	5	164	21.4	4.99	10.9	15.1	18.3	21.3	24.4	28.4	31.3

4. Physiological Function

Table 3-1-4-1 Resting heart rate (bpm)

Gender	Age group (years)	n	Mean	SD	P ₃	P ₁₀	P ₂₅	P ₅₀	P ₇₅	P ₉₀	P ₉₇
M	3	229	101.3	9.61	82.9	89.0	95.0	101.0	107.0	114.0	120.1
	4	194	98.1	10.10	80.0	85.5	90.8	98.0	104.0	112.0	119.2
	5	228	95.4	9.96	74.9	83.0	88.0	96.0	103.0	108.0	112.0
F	3	142	100.5	9.48	83.0	87.0	94.0	100.0	107.3	113.0	118.0
	4	126	99.3	9.09	81.2	87.0	93.0	99.0	106.0	112.3	115.2
	5	165	97.3	9.63	79.9	85.6	90.0	97.0	105.0	110.0	116.0

5. Physical Fitness

Table 3-1-5-1 10m shuttle run (sec)

Gender	Age group (years)	n	Mean	SD	P ₃	P ₁₀	P ₂₅	P ₅₀	P ₇₅	P ₉₀	P ₉₇
M	3	232	9.8	1.77	7.4	7.9	8.6	9.5	10.7	12.3	14.3
	4	194	8.2	1.22	6.6	6.8	7.4	8.1	9.0	10.0	11.2
	5	230	7.2	0.74	6.1	6.4	6.6	7.1	7.6	8.3	8.9
F	3	143	10.1	1.76	7.8	8.3	8.8	9.7	11.3	12.4	14.0
	4	129	8.2	1.04	6.6	6.9	7.4	8.1	8.8	9.7	10.8
	5	164	7.4	0.77	6.1	6.5	6.8	7.4	7.9	8.5	8.9

Table 3-1-5-2 Successive jumps with both feet (sec)

Gender	Age group (years)	n	Mean	SD	P ₃	P ₁₀	P ₂₅	P ₅₀	P ₇₅	P ₉₀	P ₉₇
M	3	227	12.9	5.85	5.8	7.0	8.7	11.1	16.0	22.0	28.0
	4	193	8.9	3.61	4.8	5.4	6.3	7.9	10.8	13.7	17.6
	5	230	6.9	2.10	4.6	5.0	5.4	6.3	8.0	9.3	11.3
F	3	140	12.5	5.36	5.9	7.0	8.7	11.1	14.9	20.3	25.9
	4	128	8.2	2.48	4.9	5.3	6.3	7.6	9.4	11.7	14.9
	5	164	7.0	1.90	4.6	5.0	5.6	6.5	8.0	9.3	11.0

Table 3-1-5-3 Standing long jump (cm)

Gender	Age group (years)	n	Mean	SD	P ₃	P ₁₀	P ₂₅	P ₅₀	P ₇₅	P ₉₀	P ₉₇
M	3	231	50.0	16.89	19.0	30.0	38.0	48.0	63.0	71.8	82.0
	4	194	76.6	19.05	38.0	45.0	65.0	79.0	89.0	99.5	113.0
	5	230	95.1	15.45	67.0	78.1	87.0	94.0	104.0	113.0	125.2
F	3	141	49.3	16.40	22.8	32.2	37.0	45.0	61.5	73.8	85.0
	4	129	75.5	16.14	39.8	52.0	65.5	77.0	87.0	94.0	103.2
	5	164	91.0	16.94	46.9	70.5	84.3	90.5	103.0	113.5	123.1

Table 3-1-5-4 Tennis ball distance throw (m)

Gender	Age group (years)	n	Mean	SD	P ₃	P ₁₀	P ₂₅	P ₅₀	P ₇₅	P ₉₀	P ₉₇
M	3	232	2.5	1.00	1.0	1.5	1.5	2.5	3.0	4.0	4.5
	4	194	3.8	1.40	1.5	2.5	3.0	3.5	4.5	5.5	7.0
	5	229	5.1	1.54	3.0	3.5	4.0	5.0	6.0	7.0	9.0
F	3	142	2.2	0.88	1.0	1.5	1.5	2.0	2.5	3.5	4.4
	4	129	3.3	1.09	1.5	2.0	2.5	3.0	4.0	5.0	5.6
	5	165	4.2	1.21	2.5	3.0	3.5	4.0	5.0	5.5	7.0

Table 3-1-5-5 Sit and reach (cm)

Gender	Age group (years)	n	Mean	SD	P ₃	P ₁₀	P ₂₅	P ₅₀	P ₇₅	P ₉₀	P ₉₇
M	3	232	9.6	3.61	3.1	4.8	7.0	9.5	12.0	14.9	16.3
	4	193	9.0	4.41	0.6	3.1	6.2	8.6	12.6	14.9	16.5
	5	230	7.3	4.77	-2.3	1.0	4.0	7.0	10.9	13.6	15.4
F	3	143	11.1	3.40	4.0	6.6	9.0	11.2	13.4	15.2	17.4
	4	129	11.5	3.84	3.1	6.3	9.3	11.8	14.3	16.4	17.4
	5	165	9.5	5.25	-1.8	1.5	6.0	10.4	13.2	16.0	17.9

Table 3-1-5-6 Walking on balance beam (sec)

Gender	Age group (years)	n	Mean	SD	P ₃	P ₁₀	P ₂₅	P ₅₀	P ₇₅	P ₉₀	P ₉₇
M	3	224	24.4	14.67	7.5	9.7	13.1	21.1	32.4	45.1	64.6
	4	193	14.0	11.62	3.9	4.9	7.0	9.4	17.1	29.5	50.1
	5	227	8.8	5.07	3.5	4.0	5.0	7.4	11.2	16.4	23.3
F	3	138	21.8	15.00	6.4	8.2	10.6	16.6	28.5	44.3	64.8
	4	129	12.8	8.52	4.5	5.7	7.2	10.3	15.7	23.5	32.8
	5	164	10.5	7.96	3.0	4.1	5.8	8.0	13.2	19.1	32.1

6. Teeth

Table 3-1-6-1 Prevalence of decayed primary teeth (%)

Gender	Age group (years)	Subjects (n)	Decayed primary teeth (d)	Filled primary teeth (f)	Missing primary teeth (m)	Decayed-missing-filled primary teeth (dmf)
M	3	232	25.4	1.3	0.9	26.3
	4	194	44.3	8.2	2.2	45.3
	5	230	40.4	14.9	0.5	48.7
F	3	143	25.9	0.0	0.0	25.9
	4	129	39.5	13.0	1.6	44.2
	5	165	39.4	8.3	2.6	41.2

Table 3-1-6-2 Prevalence of decayed permanent teeth (%)

Gender	Age group (years)	Subjects (n)	Decayed permanent teeth (D)	Filled permanent teeth (F)	Missing permanent teeth (M)	Decayed-missing-filled permanent teeth (DMF)
M	3	232	0.0	0.0	0.0	0.0
	4	194	0.0	0.0	0.0	0.0
	5	230	0.9	0.4	0.4	0.9
F	3	143	0.0	0.0	0.0	0.0
	4	129	0.0	0.0	0.0	0.0
	5	165	0.6	0.0	0.6	0.6

II. Children and Adolescents (Students)

1. Basic Information of Subjects

Table 3-2-1-1 Distribution of sampling sites (schools/universities)

Subject	Area/ Parish	Sampling site (school / university)	M		F		Total	
			Subjects (n)	Percentage (%)	Subjects (n)	Percentage (%)	Subjects (n)	Percentage (%)
Primary and secondary students	Northern area	Keang Peng School	397	15.7	356	17.6	753	16.5
		Hou Kong Middle School	512	20.2	376	18.6	888	19.5
		Pui Ching Middle School	438	17.3	418	20.7	856	18.8
	Central area	Colegio Dom Bosco (Yuet Wah) Chinese Section	164	6.5	20	1.0	184	4.0
		Yuet Wah College (Chinese Section)	210	8.3	0	0.0	210	4.6
		Sacred Heart Canossian College	33	1.3	258	12.8	291	6.4
	Southern area	Pooi To Middle School	443	17.5	352	17.4	795	17.5
		Estrela do Mar School	336	13.3	240	11.9	576	12.7
	Total			2533	100.0	2020	100.0	4553
University students	Nossa Senhora do Carmo	University of Macau	261	68.1	255	63.9	516	66.0
		Macao University of Science and Technology	16	4.2	24	6.0	40	5.1
	Sé Catedral	Macao Polytechnic Institute	39	10.2	48	12.0	87	11.1
	Santo António	Kiang Wu Nursing College of Macau	1	0.26	22	5.5	23	2.9
	Nossa Senhora de Fátima	Institute for Tourism Studies	26	6.8	21	5.3	47	6.0
	Others		40	10.4	29	7.3	69	8.8
Total			383	100.0	399	100.0	782	100.0

Table 3-2-1-2 Residential distribution of subjects (%)

Gender	Parish	Residential distribution of subjects (%)													Total	
		Keang Peng School	Hou Kong Middle School	Pui Ching Middle School	Colegio Dom Bosco (Yuet Wah) Chinese	Yuet Wah College (Chinese Section)	Sacred Heart Canossian College	Pooi To Middle School	Estrela do Mar School	University of Macau	Macao University of Science and Technology	Macao Polytechnic Institute	Kiang Wu Nursing College of Macau	Institute for Tourism Studies		Others
M	Paróquia de São Francisco Xavier	1.0	2.1	1.4	0.6	1.4	3.0	4.1	4.2	5.0	31.3	0.0	0.0	15.4	7.5	2.8
	Paróquia de Nossa Senhora do Carmo	1.0	3.1	14.4	7.9	9.0	6.1	22.3	5.1	27.6	12.5	17.9	0.0	34.6	37.5	11.6
	Paróquia de São Lourenço	0.5	1.6	1.8	1.8	2.9	3.0	15.8	56.3	7.7	6.3	12.8	0.0	7.7	10.0	10.9
	Paróquia da Sé Catedral	2.0	5.3	8.2	4.9	7.1	0.0	23.7	9.2	3.8	12.5	10.3	0.0	0.0	7.5	8.5
	Paróquia de Santo António	8.3	40.6	34.0	24.4	29.5	36.4	9.9	6.0	10.0	12.5	20.5	0.0	7.7	10.0	20.9
	Paróquia de São Lázaro	2.3	6.1	15.3	8.5	7.6	6.1	7.0	2.7	4.6	0.0	0.0	0.0	0.0	0.0	6.6
	Paróquia de Nossa Senhora de Fátima	83.4	36.5	24.0	51.2	41.0	45.5	16.3	14.6	34.9	6.3	38.5	100.0	19.2	15.0	35.9
	Others	1.5	4.7	0.9	0.6	1.4	0.0	0.9	2.1	6.5	18.8	0.0	0.0	15.4	12.5	2.7
F	Paróquia de São Francisco Xavier	2.5	2.1	1.0	5.0	0.0	3.0	5.4	3.8	3.9	4.2	2.1	13.6	9.5	6.7	2.9
	Paróquia de Nossa Senhora do Carmo	2.0	2.7	15.6	0.0	0.0	6.1	19.6	4.6	22.4	70.8	10.4	54.5	42.9	36.7	11.5
	Paróquia de São Lourenço	1.4	2.4	2.2	5.0	0.0	3.0	19.9	61.7	8.2	0.0	4.2	0.0	0.0	3.3	11.2
	Paróquia da Sé Catedral	1.1	6.1	9.1	5.0	0.0	0.0	23.9	7.5	4.3	8.3	8.3	0.0	4.8	3.3	8.1
	Paróquia de Santo António	6.5	38.3	32.5	25.0	0.0	36.4	10.5	7.1	11.4	4.2	12.5	4.5	14.3	6.7	20.4
	Paróquia de São Lázaro	1.7	8.2	14.8	15.0	0.0	6.1	3.7	2.1	3.5	0.0	4.2	0.0	0.0	0.0	6.0
	Paróquia de Nossa Senhora de Fátima	84.3	38.0	24.2	45.0	0.0	45.5	16.2	12.9	43.5	4.2	58.3	4.5	23.8	23.3	38.2
	Others	0.6	2.1	0.7	0.0	0.0	0.0	0.9	0.4	2.7	8.3	0.0	22.7	4.8	20.0	1.7

Table 3-2-1-3 The proportion of students in different birthplaces (%)

Gender	Birthplace	Ages 6~12	Ages 13~18	Ages 19~22	Total
M	Mainland China	5.4	22.1	42.8	23.4
	Macao	90.5	72.7	52.7	71.9
	Hong Kong	3.4	3.1	2.1	2.9
	Portugal	0.1	0.0	0.0	0.0
	Others	0.6	2.1	2.4	1.7
F	Mainland China	7.3	26.1	44.2	25.8
	Macao	87.4	67.7	50.6	68.6
	Hong Kong	3.7	4.2	3.2	3.7
	Portugal	0.0	0.0	0.0	0.0
	Others	1.6	2.0	1.9	1.8

2. Lifestyle

Table 3-2-2-1 The proportion of different daily accumulated time spending on TV, video and video games on school days in students (%)

Category	Gender	Subjects (n)	Basically none	Less than 1 hour	1~2 hours	2~3 hours	3~4 hours	4 hours or more
Primary	M	1307	10.9	48.8	22.6	8.3	4.9	4.5
	F	942	10.0	51.5	21.2	8.1	4.3	5.0
	Total	2249	10.5	49.9	22.0	8.2	4.6	4.8
Secondary	M	1226	1.9	11.1	22.2	20.4	19.8	24.6
	F	1078	0.3	9.9	18.1	18.7	19.2	33.8
	Total	2304	1.1	10.5	20.3	19.6	19.5	28.9

Table 3-2-2-2 The proportion of different daily accumulated time spending on TV, video and video games on rest days in students (%)

Category	Gender	Subjects (n)	Basically none	Less than 1 hour	1~2 hours	2~3 hours	3~4 hours	4 hours or more
Primary	M	1307	1.0	20.1	28.1	15.1	11.5	24.2
	F	942	2.2	23.6	28.6	14.1	12.4	19.0
	Total	2249	1.5	22.0	28.3	14.7	11.9	21.6
Secondary	M	1226	1.1	2.4	9.4	11.2	15.8	60.2
	F	1078	0.2	2.6	8.2	7.5	13.7	67.8
	Total	2304	0.7	2.5	8.8	9.5	14.8	63.8

Table 3-2-2-3 The proportion of different daily sleep time on school days in male students (%)

Category	Subjects (n)	Less than 8 hours	8~10 hours	10 hours or more
Primary	1307	12.0	79.8	8.2
Secondary	1226	50.8	44.3	4.9
University*	383	54.3	40.5	5.2

* Records were made without distinction between school days and rest days in the category of university.

Table 3-2-2-4 The proportion of different daily sleep time on school days in female students (%)

Category	Subjects (n)	Less than 8 hours	8~10 hours	10 hours or more
Primary	942	12.6	77.5	9.9
Secondary	1078	67.9	29.6	2.5
University*	399	54.9	38.6	6.5

* Records were made without distinction between school days and rest days in the category of university.

Table 3-2-2-5 The proportion of different daily sleep time on rest days in male students (%)

Category	Subjects (n)	Less than 8 hours	8~10 hours	10 hours or more
Primary	1307	6.8	63.4	29.8
Secondary	1226	14.8	53.1	32.1
University*	383	54.3	40.5	5.2

* Records were made without distinction between school days and rest days in the category of university.

Table 3-2-2-6 The proportion of different daily sleep time on rest days in female students (%)

Category	Subjects (n)	Less than 8 hours	8~10 hours	10 hours or more
Primary	942	5.9	53.3	40.8
Secondary	1078	12.1	52.8	35.2
University*	399	55.0	38.6	6.5

* Records were made without distinction between school days and rest days in the category of university.

Table 3-2-2-7 The proportion of different weekly frequencies of physical education (PE) class in male students (%)

Category	Subjects (n)	Once	Twice	None
Primary	1307	33.9	65.7	0.5
Secondary	1226	67.5	31.7	0.7

Table 3-2-2-8 The proportion of different weekly frequencies of physical education (PE) class in female students (%)

Category	Subjects (n)	Once	Twice	None
Primary	942	26.9	72.5	0.6
Secondary	1078	51.0	48.5	0.5

Table 3-2-2-9 The proportion of different duration of physical education (PE) class per week in male students (%)

Category	Participants (n)	Less than 30 minutes	30 minutes~1 hour	1~1.5 hours	1.5 hours or more
Primary	1301	0.0	67.3	32.7	0.0
Secondary	1217	0.0	32.0	68.0	0.0

Table 3-2-2-10 The proportion of different duration of physical education (PE) class per week in female students (%)

Category	Participants (n)	Less than 30 minutes	30 minutes~1 hour	1~1.5 hours	1.5 hours or more
Primary	936	0.0	74.4	25.6	0.0
Secondary	1073	0.0	48.7	51.3	0.0

Table 3-2-2-11 The proportion of different self-perceived intensities of PE class in male students (%)

Category	Participants (n)	Low	Moderate	High
Primary	1301	16.0	64.9	19.1
Secondary	1217	9.1	68.4	22.5

Table 3-2-2-12 The proportion of different self-perceived intensities of PE class in female students (%)

Category	Participants (n)	Low	Moderate	High
Primary	936	17.3	71.2	11.5
Secondary	1073	7.0	73.6	19.4

Table 3-2-2-13 The proportion of different weekly frequencies of extracurricular physical exercise in male students (%)

Category	Subjects (n)	Never	Less than 1 time	1~2 times	3~4 times	5~6 times	7 times or more
Primary	1307	15.5	--	52.1	22.3	6.1	4.0
Secondary	1226	24.1	--	36.3	23.2	11.3	5.1
University*	383	3.4	9.7	38.9	30.5	12.5	5.0

* It referred to the frequency of routine physical exercise (including extracurricular exercise and PE class) in the category of university.

Table 3-2-2-14 The proportion of different weekly frequencies of extracurricular physical exercise in female students (%)

Category	Subjects (n)	Never	Less than 1 time	1~2 times	3~4 times	5~6 times	7 times or more
Primary	942	16.3	--	53.1	22.0	6.3	2.3
Secondary	1078	28.4	--	43.0	20.1	6.4	2.0
University*	399	3.8	11.2	53.6	22.8	6.3	2.5

* It referred to the frequency of routine physical exercise (including extracurricular exercise and PE class) in the category of university.

Table 3-2-2-15 The proportion of different duration of each extracurricular physical exercise in male students (%)

Category	Participants (n)	Less than 30 minutes	30 minutes~1 hour	1~1.5 hours	1.5 hours or more	1~2 hours	2 hours or more
Primary	1105	10.3	42.6	29.1	17.9	--	--
Secondary	931	15.9	33.4	22.9	27.8	--	--
University	370	15.1	29.2	--	--	40.3	15.4

Table 3-2-2-16 The proportion of different duration of each extracurricular physical exercise in female students (%)

Category	Participants (n)	Less than 30 minutes	30 minutes~1 hour	1~1.5 hours	1.5 hours or more	1~2 hours	2 hours or more
Primary	788	13.2	49.7	23.2	13.8	--	--
Secondary	772	24.9	37.7	20.0	17.4	--	--
University	384	21.4	39.6	--	--	32.0	7.0

Table 3-2-2-17 The proportion of different self-perceived intensities of extracurricular physical exercise in male students (%)

Category	Participants (n)	Low	Moderate	High
Primary	1105	15.7	62.4	21.9
Secondary	931	8.1	54.5	37.5
University	370	4.6	44.3	51.1

Table 3-2-2-18 The proportion of different self-perceived intensities of extracurricular physical exercise in female students (%)

Category	Participants (n)	Low	Moderate	High
Primary	788	17.9	67.1	15.0
Secondary	772	8.8	63.9	27.3
University	384	3.9	65.9	30.2

Table 3-2-2-19 The participation rate of different physical exercises (at and after school) by male students (%)

Category	Subjects (n)	1 st	2 nd	3 rd	4 th	5 th	6 th	7 th	8 th
Primary 1-3	698	Running (55.4)	Walking (53.3)	Swimming (41.5)	Cycling (40.5)	Basketball (17.2)	Rope skipping (14.8)	Football (14.6)	Badminton (14.6)
Primary 4-6	609	Swimming (39.1)	Cycling (38.6)	Basketball (31.7)	Brisk walking (28.1)	Badminton (27.3)	Short- and middle-distance running (25.6)	Table tennis (24.5)	Rope skipping (17.1)
Secondary	1226	Basketball (32.4)	Short- and middle-distance running (30.5)	Brisk walking (23.5)	Badminton (23.5)	Cycling (22.0)	Swimming (20.0)	Long-distance running (18.1)	Table tennis (15.7)
University	383	Running (66.8)	Walking (60.1)	Basketball (47.3)	Badminton (33.2)	Swimming (31.3)	Cycling (30.3)	Strength exercise, body building (22.2)	Football (21.7)

Table 3-2-2-20 The participation rate of different physical exercises (at and after school) by female students (%)

Category	Subjects (n)	1 st	2 nd	3 rd	4 th	5 th	6 th	7 th	8 th
Primary 1-3	480	Walking (59.2)	Running (50.8)	Dancing (46.7)	Swimming (37.3)	Bicycling (35.2)	Rope skipping (26.9)	Gymnastics (18.3)	Badminton (12.1)
Primary 4-6	462	Swimming (34.6)	Cycling (34.4)	Rope skipping (32.0)	Brisk walking (28.4)	Rhythmic gymnastics (27.1)	Badminton (26.2)	Short- and middle-distance running (22.7)	Gymnastics (16.2)
Secondary	1078	Short- and middle-distance running (38.1)	Brisk walking (30.9)	Badminton (26.0)	Cycling (18.4)	Swimming (16.5)	Rope skipping (16.2)	Rhythmic gymnastics (15.0)	Basketball (14.5)
University	399	Walking (77.2)	Running (73.9)	Badminton (35.1)	Yoga, Pilates (32.6)	Swimming (30.6)	Cycling (30.3)	Basketball (21.8)	Dancing (19.3)

Table 3-2-2-21 The proportion of different weekly frequencies of strength exercise in male students (%)

Category	Subjects (n)	1 day	2 days	3 days	4 days	5 days	6 days	7 days	0 day
Primary	1307	19.9	12.6	7.6	1.6	2.1	0.9	1.8	53.5
Secondary	1226	19.9	17.4	14.1	5.3	4.9	1.1	2.9	34.5
University	383	17.0	18.5	12.3	6.8	3.9	2.1	3.7	35.8

Table 3-2-2-22 The proportion of different weekly frequencies of strength exercise in female students (%)

Category	Subjects (n)	1 day	2 days	3 days	4 days	5 days	6 days	7 days	0 day
Primary	942	19.6	15.3	7.5	2.9	1.5	0.6	1.3	51.2
Secondary	1078	24.0	15.0	9.0	2.7	1.6	0.6	0.6	46.4
University	399	18.8	15.0	9.0	3.8	1.8	1.3	0.5	49.9

Table 3-2-2-23 The proportion of male students with and without diagnosed diseases in the past five years (%)

Age group (years)	Subjects (n)	Yes	No
6	238	28.6	71.4
7	238	21.0	79.0
8	257	28.0	72.0
9	188	25.5	74.5
10	199	35.7	64.3
11	180	33.3	66.7
12	208	32.2	67.8
13	200	34.5	65.5
14	186	29.6	70.4
15	169	31.4	68.6
16	174	25.3	74.7
17	184	29.9	70.1
18	163	19.0	81.0
19	127	26.8	73.2
20	106	26.4	73.6
21	58	31.0	69.0
22	41	17.1	82.9

Table 3-2-2-24 The proportion of female students with and without diagnosed diseases in the past five years (%)

Age group (years)	Subjects (n)	Yes	No
6	171	16.4	83.6
7	172	18.6	81.4
8	157	23.6	76.4
9	160	17.5	82.5
10	142	27.5	72.5
11	151	23.8	76.2
12	185	35.7	64.3
13	155	33.5	66.5
14	151	31.1	68.9
15	152	39.5	60.5
16	158	31.6	68.4
17	200	29.5	70.5
18	156	27.6	72.4
19	117	33.3	66.7
20	97	34.0	66.0
21	63	25.4	74.6
22	32	34.4	65.6

Table 3-2-2-25 Percentage of various diagnosed diseases in the past five years in male students (%)

Category	Subjects diagnosed with disease (n)	1 st	2 nd	3 rd	4 th	5 th	6 th	7 th	8 th
Primary	371	Allergic rhinitis (32.1)	Gastroenteritis (26.1)	Others (26.1)	Tracheitis (24.0)	Tonsillitis (15.1)	Pneumonia (9.4)	Asthma (8.1)	Varicella (7.3)
Secondary	373	Gastroenteritis (27.6)	Allergic rhinitis (26.3)	Asthma (7.8)	Tonsillitis (7.8)	Varicella (7.8)	Tracheitis (6.7)	Pneumonia (2.9)	Anemia (2.9)
University	86	Accidental injury (22.1)	Acute/chronic enteritis (18.6)	Acute/chronic rhinitis (16.3)	Others (15.1)	Asthma (9.3)	Acute/chronic pharyngitis (8.1)	Dental ulcer (7.0)	Allergic dermatitis (7.0)

Table 3-2-2-26 Percentage of various diagnosed diseases in the past five years in female students (%)

Category	Subjects diagnosed with disease (n)	1 st	2 nd	3 rd	4 th	5 th	6 th	7 th	8 th
Primary	198	Gastroenteritis (27.3)	Tracheitis (24.7)	Tonsillitis (24.7)	Allergic rhinitis (24.2)	Others (20.7)	Pneumonia (11.6)	Varicella (9.6)	Diarrhea (6.1)
Secondary	356	Gastroenteritis (38.8)	Allergic rhinitis (24.2)	Tonsillitis (8.7)	Varicella (7.6)	Anemia (7.3)	Tracheitis (5.1)	Diarrhea (4.8)	Spinal deformity (4.5)
University	123	Dysmenorrhea, irregular menses (47.2)	Dental ulcer (22.0)	Acute/chronic enteritis (17.1)	Acute/chronic rhinitis (13.8)	Others (13.8)	Anemia (11.4)	Allergic dermatitis (8.9)	Acute/chronic pharyngitis (5.7)

Table 3-2-2-27 The proportion of male students with and without daily tooth brushing habit (%)

Age group (years)	Subjects (n)	Yes	No
6	238	97.1	2.9
7	238	96.6	3.4
8	257	93.0	7.0
9	188	94.7	5.3
10	199	95.5	4.5
11	180	96.1	3.9
12	208	94.7	5.3
13	200	94.0	6.0
14	186	97.8	2.2
15	169	96.4	3.6
16	174	97.7	2.3
17	184	95.1	4.9
18	163	98.2	1.8
19	127	96.1	3.9
20	106	97.2	2.8
21	58	96.6	3.4
22	41	100.0	0.0

Table 3-2-2-28 The proportion of female students with and without daily tooth brushing habit (%)

Age group (years)	Subjects (n)	Yes	No
6	171	95.9	4.1
7	172	98.3	1.7
8	157	96.8	3.2
9	160	95.6	4.4
10	142	97.9	2.1
11	151	98.7	1.3
12	185	95.7	4.3
13	155	98.7	1.3
14	151	98.0	2.0
15	152	98.0	2.0
16	158	100.0	0.0
17	200	99.0	1.0
18	156	96.2	3.8
19	117	99.1	0.9
20	97	99.0	1.0
21	63	98.4	1.6
22	32	100.0	0.0

Table 3-2-2-29 The proportion of male students with and without daily tooth flossing habit (%)

Age group (years)	Subjects (n)	Yes	No
6	238	16.8	83.2
7	238	13.4	86.6
8	257	12.8	87.2
9	188	12.8	87.2
10	199	13.6	86.4
11	180	15.0	85.0
12	208	10.6	89.4
13	200	11.0	89.0
14	186	16.1	83.9
15	169	12.4	87.6
16	174	10.3	89.7
17	184	10.3	89.7
18	163	5.5	94.5
19	127	13.4	86.6
20	106	16.0	84.0
21	58	15.5	84.5
22	41	4.9	95.1

Table 3-2-2-30 The proportion of female students with and without daily tooth flossing habit (%)

Age group (years)	Subjects (n)	Yes	No
6	171	16.4	83.6
7	172	11.6	88.4
8	157	11.5	88.5
9	160	15.0	85.0
10	142	13.4	86.6
11	151	9.9	90.1
12	185	17.8	82.2
13	155	14.8	85.2
14	151	16.6	83.4
15	152	15.1	84.9
16	158	16.5	83.5
17	200	19.5	80.5
18	156	15.4	84.6
19	117	13.7	86.3
20	97	18.6	81.4
21	63	22.2	77.8
22	32	15.6	84.4

Table 3-2-2-31 The proportion of male students who had and had not been to clinics for dental examination in the past 12 months (%)

Age group (years)	Subjects (n)	Yes	No
6	238	62.2	37.8
7	238	63.4	36.6
8	257	72.0	28.0
9	188	57.4	42.6
10	199	44.2	55.8
11	180	46.1	53.9
12	208	32.2	67.8
13	200	31.5	68.5
14	186	39.8	60.2
15	169	32.0	68.0
16	174	31.6	68.4
17	184	27.2	72.8
18	163	36.2	63.8
19	127	33.1	66.9
20	106	31.1	68.9
21	58	39.7	60.3
22	41	34.1	65.9

Table 3-2-2-32 The proportion of female students who had and had not been to clinics for dental examination in the past 12 months (%)

Age group (years)	Subjects (n)	Yes	No
6	171	60.2	39.8
7	172	64.5	35.5
8	157	70.7	29.3
9	160	53.1	46.9
10	142	46.5	53.5
11	151	43.0	57.0
12	185	41.1	58.9
13	155	39.4	60.6
14	151	51.0	49.0
15	152	53.3	46.7
16	158	45.6	54.4
17	200	48.0	52.0
18	156	51.3	48.7
19	117	50.4	49.6
20	97	44.3	55.7
21	63	55.6	44.4
22	32	56.3	43.8

Table 3-2-2-33 The proportion of male students with and without dental caries (%)

Age group (years)	Subjects (n)	Yes	No	Don't know
6	238	38.2	31.9	29.8
7	238	47.5	25.2	27.3
8	257	41.2	25.7	33.1
9	188	36.2	28.7	35.1
10	199	29.1	24.6	46.2
11	180	18.3	31.1	50.6
12	208	12.0	24.0	63.9
13	200	12.0	33.0	55.0
14	186	11.3	37.1	51.6
15	169	11.2	27.2	61.5
16	174	17.2	28.7	54.0
17	184	13.0	23.9	63.0
18	163	12.3	27.6	60.1
19	127	12.6	24.4	63.0
20	106	17.0	34.9	48.1
21	58	5.2	22.4	72.4
22	41	9.8	36.6	53.7

Table 3-2-2-34 The proportion of female students with and without dental caries (female) (%)

Age group (years)	Subjects (n)	Yes	No	Don't know
6	171	33.3	38.0	28.7
7	172	40.7	26.2	33.1
8	157	49.0	24.2	26.8
9	160	34.4	26.3	39.4
10	142	29.6	29.6	40.8
11	151	22.5	25.8	51.7
12	185	18.4	27.0	54.6
13	155	19.4	35.5	45.2
14	151	21.9	29.8	48.3
15	152	25.0	23.0	52.0
16	158	17.7	27.8	54.4
17	200	22.0	21.0	57.0
18	156	24.4	25.0	50.6
19	117	29.1	26.5	44.4
20	97	20.6	32.0	47.4
21	63	31.7	36.5	31.7
22	32	12.5	43.8	43.8

Table 3-2-2-35 The proportion of male students with dental caries who had and did not have dental treatment at clinics (%)

Age group (years)	Subjects with dental caries (n)	Yes	No
6	91	87.9	12.1
7	113	83.2	16.8
8	106	89.6	10.4
9	68	80.9	19.1
10	58	81.0	19.0
11	33	69.7	30.3
12	25	84.0	16.0
13	24	83.3	16.7
14	21	57.1	42.9
15	19	68.4	31.6
16	30	50.0	50.0
17	25	56.0	44.0
18	20	65.0	35.0
19	16	31.3	68.8
20	18	55.6	44.4
21	3	66.7	33.3
22	4	100.0	0.0

Table 3-2-2-36 The proportion of female students with dental caries who had and did not have dental treatment at clinics (%)

Age group (years)	Subjects with dental caries (n)	Yes	No
6	57	80.7	19.3
7	70	84.3	15.7
8	77	88.3	11.7
9	55	81.8	18.2
10	42	66.7	33.3
11	34	67.6	32.4
12	34	70.6	29.4
13	30	76.7	23.3
14	33	84.8	15.2
15	38	68.4	31.6
16	28	82.1	17.9
17	44	70.5	29.5
18	38	68.4	31.6
19	34	79.4	20.6
20	20	95.0	5.0
21	20	90.0	10.0
22	4	100.0	0.0

3. Anthropometric Measurements

Table 3-2-3-1 Height (cm)

Gender	Age group (years)	n	Mean	SD	P ₃	P ₁₀	P ₂₅	P ₅₀	P ₇₅	P ₉₀	P ₉₇	
M	6	238	120.0	5.5	110.3	113.3	115.7	119.6	124.0	127.4	131.9	
	7	238	125.5	6.2	112.0	117.5	121.0	125.5	129.3	133.4	138.0	
	8	257	130.6	6.0	119.6	123.1	126.7	130.5	134.4	137.7	142.9	
	9	188	136.5	6.1	124.6	128.6	132.2	136.2	140.6	143.9	148.2	
	10	198	142.0	7.0	129.1	133.3	136.6	141.6	147.0	151.6	154.6	
	11	180	149.2	8.2	133.4	139.3	143.0	149.4	154.3	161.1	165.8	
	12	207	156.7	8.7	140.2	144.5	150.4	157.3	163.4	167.5	172.9	
	13	200	164.2	7.7	149.6	154.4	159.3	164.4	169.2	174.0	179.0	
	14	186	167.5	7.0	152.9	158.6	162.6	168.0	172.3	176.6	180.9	
	15	169	170.7	5.8	160.2	163.0	167.0	170.0	174.5	178.4	182.3	
	16	174	172.7	6.0	162.5	164.9	168.5	172.1	176.9	181.2	184.8	
	17	184	172.5	6.0	160.2	165.9	169.0	172.1	176.5	180.7	183.8	
	18	163	172.8	6.0	162.0	165.0	168.4	173.0	177.1	180.4	185.5	
	19	127	174.1	6.3	162.3	166.8	169.9	173.3	178.5	183.3	185.2	
	20	106	173.1	7.2	162.5	164.6	168.4	172.9	177.7	181.7	189.1	
	21	58	172.0	5.3	157.0	166.3	167.9	172.1	176.0	178.4	182.3	
	22	41	171.8	5.9	161.5	163.3	167.1	172.1	176.5	178.9	184.0	
	F	6	171	118.7	5.6	109.0	111.3	115.0	118.3	122.6	126.0	129.9
		7	172	124.6	5.3	114.0	117.2	121.2	124.5	128.5	131.0	134.9
		8	157	130.6	6.8	119.4	122.7	126.0	130.2	134.4	140.1	145.1
		9	160	136.2	6.7	123.7	127.4	131.7	135.8	141.1	145.3	148.1
		10	142	143.9	7.4	129.3	134.2	138.5	144.6	149.1	153.3	158.2
11		151	150.9	6.7	138.4	141.7	146.0	151.1	155.6	158.8	163.5	
12		185	155.2	5.7	144.5	147.9	151.5	155.5	159.1	162.5	164.6	
13		155	157.8	5.7	147.2	151.0	153.6	157.6	162.1	165.2	168.6	
14		151	159.4	5.7	147.5	152.5	156.0	159.5	163.4	166.3	170.8	
15		152	160.7	4.8	151.5	154.0	157.6	161.0	164.0	166.4	170.2	
16		158	160.7	5.4	150.8	154.3	157.1	160.0	164.4	167.7	171.6	
17		200	161.0	5.4	149.2	154.6	157.2	161.0	164.6	168.1	170.5	
18		156	159.8	5.1	150.5	153.0	156.1	159.6	163.5	165.5	169.7	
19		117	160.8	5.4	151.7	153.6	157.0	160.6	165.2	167.6	171.5	
20		97	161.8	5.5	151.3	155.0	158.2	161.3	166.0	169.5	172.5	
21		63	160.5	5.5	150.4	153.5	156.0	160.3	164.8	167.6	171.3	
22		32	160.9	8.3	146.0	152.7	154.3	159.3	165.3	174.5	174.6	

Table 3-2-3-2 Sitting height (cm)

Gender	Age group (years)	n	Mean	SD	P ₃	P ₁₀	P ₂₅	P ₅₀	P ₇₅	P ₉₀	P ₉₇	
M	6	238	65.9	3.83	60.7	62.0	63.9	65.6	68.3	69.7	72.4	
	7	238	68.3	3.23	62.2	63.7	66.2	68.6	70.4	72.2	74.4	
	8	257	70.3	3.16	63.9	66.7	68.2	70.2	72.5	74.5	76.4	
	9	188	73.0	3.36	66.2	69.0	70.6	73.0	75.2	77.1	79.6	
	10	199	75.0	3.79	68.9	70.7	72.3	74.8	77.3	79.9	82.7	
	11	180	78.3	4.61	69.7	72.7	75.1	78.2	81.3	84.9	87.3	
	12	208	81.9	4.99	72.8	75.0	78.3	82.2	85.5	88.1	91.4	
	13	200	86.1	4.54	77.2	79.7	83.5	86.1	89.1	92.3	93.6	
	14	186	88.2	3.96	79.3	83.6	86.1	88.5	90.8	93.0	95.3	
	15	169	90.7	3.26	84.7	86.5	88.5	90.7	92.7	95.2	96.9	
	16	174	91.7	3.25	85.7	87.3	89.4	92.0	93.7	96.2	98.4	
	17	184	92.1	3.19	86.1	88.0	89.8	92.1	94.3	96.3	98.3	
	18	163	92.2	2.96	86.3	88.5	90.4	92.2	94.3	96.4	97.8	
	19	127	93.1	3.48	85.9	88.9	91.0	93.0	95.5	98.2	99.8	
	20	106	92.6	4.07	85.6	87.8	90.6	92.5	95.0	97.5	99.6	
	21	58	92.2	2.99	84.9	87.8	90.4	92.9	94.5	95.6	96.3	
	22	41	92.2	3.50	85.6	87.0	90.2	91.8	94.7	97.5	99.0	
	F	6	171	65.2	2.94	60.1	61.5	62.7	65.2	67.0	68.9	71.7
		7	172	67.9	3.91	62.5	63.9	65.6	67.5	69.5	71.7	74.3
		8	157	70.2	3.58	64.2	65.7	67.5	70.1	72.1	75.5	77.3
		9	160	72.6	3.41	66.6	68.5	70.0	72.3	74.9	77.3	80.0
		10	142	76.5	4.30	69.1	71.2	73.3	76.6	79.1	82.3	85.1
11		151	80.0	3.86	72.7	75.2	77.3	80.2	82.6	84.8	86.9	
12		185	82.3	3.30	75.7	78.0	80.5	82.6	84.5	86.1	88.4	
13		155	84.5	3.13	77.8	80.7	82.1	84.3	86.6	88.6	89.8	
14		151	85.3	3.10	79.3	81.1	83.4	85.3	87.2	89.1	91.8	
15		152	86.2	2.75	80.9	82.6	84.2	86.2	87.9	89.8	91.7	
16		158	86.5	2.87	81.1	82.9	84.9	86.5	88.4	89.9	92.2	
17		200	87.0	2.91	81.2	83.0	84.9	87.1	88.9	90.6	92.6	
18		156	86.4	2.66	81.6	82.7	84.9	86.5	88.5	89.8	90.7	
19		117	86.8	2.86	81.7	83.1	84.3	86.5	88.7	90.6	92.7	
20		97	87.1	2.94	81.4	83.3	84.9	87.1	89.5	91.0	92.1	
21		63	86.7	2.83	80.3	82.8	85.1	86.7	88.9	90.4	91.9	
22		32	86.6	3.63	80.6	81.2	84.2	86.4	89.4	91.5	91.8	

Tabela 3-2-3-3 Foot length (cm)

Gender	Age group (years)	n	Mean	SD	P ₃	P ₁₀	P ₂₅	P ₅₀	P ₇₅	P ₉₀	P ₉₇	
M	6	238	18.4	1.05	16.5	17.1	17.7	18.5	19.0	19.9	20.5	
	7	238	19.4	1.40	17.3	17.8	18.5	19.3	20.1	20.8	21.5	
	8	257	20.2	1.23	17.7	18.5	19.5	20.1	20.9	21.7	23.0	
	9	187	21.0	1.20	18.9	19.5	20.1	21.1	21.9	22.6	23.4	
	10	198	21.9	1.29	19.6	20.2	21.1	21.9	22.7	23.5	24.5	
	11	180	23.0	1.54	20.3	21.1	21.9	23.2	24.1	25.0	25.7	
	12	208	24.0	1.49	20.8	21.9	22.9	24.2	25.1	25.6	26.4	
	13	200	24.9	1.23	22.3	23.3	24.0	25.0	25.7	26.3	27.3	
	14	186	25.1	1.29	22.8	23.4	24.2	25.0	26.0	26.9	28.0	
	15	169	25.1	1.25	22.9	23.6	24.3	25.0	25.9	26.8	27.7	
	16	174	25.2	1.22	23.0	23.5	24.5	25.2	26.2	26.8	27.4	
	17	184	25.1	1.31	23.0	23.6	24.2	25.0	25.9	27.0	27.6	
	18	163	25.2	1.15	23.0	23.6	24.3	25.3	26.0	26.8	27.3	
	19	127	25.5	1.05	23.7	24.3	24.8	25.5	26.1	26.8	27.5	
	20	106	25.2	1.11	23.1	23.6	24.4	25.3	26.0	26.3	27.5	
	21	58	25.2	0.86	23.4	24.0	24.6	25.3	25.9	26.2	26.7	
	22	41	25.3	0.90	23.5	24.2	24.7	25.2	26.0	26.5	27.4	
	F	6	171	18.1	1.04	16.1	16.6	17.3	18.2	18.9	19.4	19.7
		7	172	19.1	1.00	17.0	17.6	18.5	19.1	19.7	20.2	21.1
		8	157	20.0	1.19	17.9	18.6	19.2	19.9	21.0	21.5	22.5
		9	160	20.7	1.19	18.3	19.1	19.8	20.8	21.5	22.2	22.7
		10	142	21.7	1.31	19.2	20.0	21.0	21.7	22.5	23.3	24.0
11		151	22.4	1.16	20.3	21.1	21.7	22.3	23.2	24.0	24.8	
12		185	22.7	1.06	20.9	21.4	22.0	22.8	23.4	23.9	25.0	
13		154	22.9	1.08	20.7	21.5	22.2	22.9	23.8	24.1	25.0	
14		151	23.0	1.07	20.9	21.7	22.2	23.0	23.8	24.4	25.2	
15		152	23.1	1.11	21.2	21.8	22.5	23.1	23.6	24.3	25.0	
16		158	23.1	1.05	21.1	21.7	22.2	23.1	23.7	24.5	25.0	
17		200	22.8	1.05	20.9	21.5	22.1	22.7	23.5	24.3	24.8	
18		156	22.9	0.97	21.1	21.7	22.1	22.9	23.5	24.1	24.7	
19		117	22.9	0.98	21.0	21.8	22.2	22.9	23.6	24.1	24.8	
20		97	23.0	0.99	21.3	21.8	22.2	23.0	23.8	24.4	24.7	
21		63	22.9	1.04	20.8	21.7	22.1	22.9	23.5	24.3	25.1	
22		32	23.1	1.21	20.6	21.6	22.3	23.0	23.8	24.5	24.8	

Table 3-2-3-4 Weight (kg)

Gender	Age group (years)	n	Mean	SD	P ₃	P ₁₀	P ₂₅	P ₅₀	P ₇₅	P ₉₀	P ₉₇	
M	6	238	23.0	5.05	16.7	18.0	19.6	21.7	24.8	29.5	35.1	
	7	238	25.8	5.44	17.6	20.2	21.8	24.6	28.5	33.7	37.9	
	8	257	29.0	6.73	20.5	22.0	24.6	27.3	32.6	38.2	46.3	
	9	188	34.1	8.34	22.1	24.9	28.5	32.3	37.8	47.6	53.4	
	10	199	38.5	10.24	25.0	27.9	30.8	36.5	45.4	50.4	64.8	
	11	180	44.7	13.71	26.7	30.3	34.8	42.1	51.3	65.6	79.8	
	12	208	49.5	13.83	29.1	33.8	39.7	46.8	57.2	70.4	81.6	
	13	200	55.2	13.92	35.5	40.3	46.0	53.3	61.5	73.1	87.0	
	14	186	58.8	13.61	37.1	42.8	48.8	57.3	66.0	78.0	91.6	
	15	169	61.4	12.58	44.3	47.4	52.8	59.0	67.8	81.8	91.1	
	16	174	64.2	14.84	44.3	47.7	54.2	60.8	71.9	86.0	101.6	
	17	184	65.7	14.22	46.0	50.5	54.9	62.9	73.4	86.4	97.8	
	18	163	64.8	12.00	43.3	50.1	56.8	63.6	72.1	78.9	90.8	
	19	127	68.5	14.26	49.5	52.4	58.1	65.5	75.6	85.4	105.5	
	20	106	68.7	14.62	43.7	51.4	59.4	66.3	77.7	87.1	105.2	
	21	58	71.1	12.16	54.9	56.2	63.1	69.3	79.5	83.9	109.7	
	22	41	67.7	9.27	50.9	53.8	59.7	67.4	76.4	80.8	83.1	
	F	6	171	21.7	4.25	16.6	17.5	18.8	20.9	23.3	26.6	33.9
		7	172	24.6	5.15	17.9	19.4	21.2	23.9	27.2	30.9	39.9
		8	157	28.5	6.46	20.1	22.1	23.6	27.2	31.6	37.7	43.5
		9	160	31.1	6.98	19.9	23.1	26.0	30.4	34.7	39.5	48.9
		10	142	36.9	9.90	22.7	27.2	30.4	35.0	40.9	51.2	59.6
11		151	42.6	9.72	26.9	31.3	35.1	41.8	48.7	54.8	64.6	
12		185	46.7	9.12	32.7	36.4	39.5	45.6	52.1	60.9	66.1	
13		155	49.3	9.44	36.0	39.4	42.5	47.2	54.9	61.7	68.7	
14		151	51.5	9.81	37.2	40.6	44.4	49.5	57.0	65.2	74.8	
15		152	52.2	8.76	39.2	42.2	46.3	51.0	56.5	64.1	73.9	
16		158	53.1	9.62	37.5	41.5	46.2	52.3	58.3	65.8	75.8	
17		200	53.0	9.60	39.3	43.0	47.1	51.7	56.7	63.2	79.5	
18		156	52.6	8.67	41.0	43.0	46.8	51.6	56.4	62.1	73.6	
19		117	54.5	10.64	40.9	43.1	46.6	52.5	59.6	70.3	82.2	
20		97	55.4	9.76	42.4	45.1	48.0	54.2	60.5	67.6	83.4	
21		63	54.9	8.51	41.7	43.9	49.4	54.3	60.0	66.7	73.8	
22		32	54.6	13.05	39.2	41.5	47.1	53.0	57.7	69.3	75.5	

Table 3-2-3-5 BMI

Gender	Age group (years)	n	Mean	SD	P ₃	P ₁₀	P ₂₅	P ₅₀	P ₇₅	P ₉₀	P ₉₇	
M	6	238	15.8	2.42	12.9	13.5	14.2	15.2	16.7	19.3	22.4	
	7	238	16.3	2.55	12.9	13.6	14.5	15.6	17.5	20.0	22.2	
	8	257	16.9	2.89	13.1	13.8	14.7	16.0	18.6	21.3	23.5	
	9	188	18.2	3.49	13.5	14.5	15.7	17.2	20.2	22.9	26.2	
	10	198	19.0	4.66	13.9	14.7	15.9	17.9	21.2	23.5	27.5	
	11	180	19.8	4.53	13.9	15.0	16.2	18.8	22.4	25.5	32.0	
	12	207	20.0	4.32	14.3	15.1	16.9	18.6	22.9	26.7	29.4	
	13	200	20.4	4.26	14.1	15.8	17.4	19.3	22.5	26.4	29.7	
	14	186	20.9	4.26	15.1	16.3	17.5	20.1	23.3	26.8	31.6	
	15	169	21.0	3.89	15.7	16.7	18.0	20.2	24.0	26.6	29.8	
	16	174	21.5	4.55	15.5	16.8	18.1	20.3	23.9	28.7	32.4	
	17	184	22.0	4.41	16.0	17.2	19.0	20.8	24.3	29.0	32.4	
	18	163	21.6	3.70	15.4	17.1	19.2	21.4	23.9	26.2	29.6	
	19	127	22.5	4.13	16.4	17.7	19.8	21.6	25.0	28.0	32.7	
	20	106	22.8	4.29	16.0	17.5	20.1	22.2	25.0	28.4	34.4	
	21	58	24.1	4.31	18.5	19.3	21.2	23.4	26.1	28.9	39.3	
	22	41	23.0	3.67	16.2	17.2	20.6	22.9	25.6	28.3	31.0	
	F	6	171	15.3	2.05	13.0	13.4	14.2	14.8	16.0	17.8	22.3
		7	172	15.8	2.48	12.8	13.4	14.0	15.4	16.9	18.6	22.0
		8	157	16.5	2.51	13.1	13.7	14.8	15.9	18.0	20.1	22.6
		9	160	16.6	2.72	12.9	13.5	14.6	16.2	18.2	19.6	23.3
		10	142	17.6	3.44	13.1	14.2	15.2	16.6	19.1	22.7	26.1
11		151	18.6	3.45	13.2	14.8	16.1	17.8	20.6	23.6	27.2	
12		185	19.3	3.34	14.3	15.5	16.8	19.1	21.1	23.9	27.4	
13		155	19.7	3.23	15.2	16.0	17.2	19.2	21.7	24.2	28.0	
14		151	20.2	3.55	14.7	16.4	17.9	19.5	21.8	25.2	29.7	
15		152	20.2	3.20	15.2	16.8	18.1	19.5	21.8	24.4	28.0	
16		158	20.6	3.46	15.5	16.4	18.2	20.1	22.8	25.4	28.3	
17		200	20.4	3.31	15.9	17.1	18.1	19.7	21.5	24.2	30.5	
18		156	20.6	3.17	16.2	17.5	18.7	20.1	21.9	23.7	28.7	
19		117	21.0	3.88	16.1	17.3	18.3	19.8	22.7	26.5	31.1	
20		97	21.2	3.45	16.0	17.5	18.9	20.8	22.5	25.8	30.5	
21		63	21.3	2.86	16.3	18.1	19.5	21.4	22.6	24.8	29.9	
22		32	20.9	3.36	16.8	17.3	19.0	19.9	22.2	24.2	29.1	

Table 3-2-3-6 Body fat percentage (%)

Gender	Age group (years)	n	Mean	SD	P ₃	P ₁₀	P ₂₅	P ₅₀	P ₇₅	P ₉₀	P ₉₇	
M	6	238	18.8	6.59	9.7	11.2	13.6	17.4	22.1	28.4	33.4	
	7	238	16.1	7.54	10.0	10.0	10.2	12.6	20.9	28.9	33.9	
	8	257	16.8	8.27	10.0	10.0	10.2	12.4	22.8	30.1	37.0	
	9	188	19.8	9.41	10.0	10.1	10.8	16.8	27.1	34.5	39.0	
	10	198	20.2	9.34	10.0	10.1	11.0	19.0	27.8	32.6	39.4	
	11	180	20.8	10.07	10.0	10.1	10.6	18.3	28.7	35.2	43.1	
	12	206	20.0	9.54	10.0	10.0	10.3	17.7	27.3	34.5	40.1	
	13	198	19.8	8.95	10.0	10.0	11.2	17.1	26.6	33.6	38.7	
	14	186	19.5	8.76	10.0	10.1	11.1	17.6	26.1	31.8	36.8	
	15	164	18.5	7.86	10.0	10.1	11.7	16.4	24.5	31.1	34.5	
	16	172	19.0	8.09	10.0	10.0	11.2	17.3	25.4	32.5	34.6	
	17	178	18.9	7.78	10.0	10.0	12.2	16.9	24.0	31.1	35.1	
	18	163	17.3	6.58	10.0	10.0	10.6	15.7	21.9	26.5	32.3	
	19	127	18.7	7.16	10.0	10.1	12.1	18.2	23.2	28.7	34.2	
	20	106	19.5	7.18	10.0	10.1	13.8	18.8	24.9	29.3	35.3	
	21	58	20.9	6.24	10.8	13.4	15.4	21.7	25.2	28.7	36.4	
	22	41	18.3	6.43	10.0	10.2	12.6	16.8	23.7	28.0	32.3	
	F	6	171	21.6	5.88	12.6	15.1	17.3	20.7	24.7	28.9	35.9
		7	172	22.9	7.98	10.4	13.2	17.0	22.2	27.4	33.4	40.4
		8	157	23.2	8.11	10.4	13.0	16.6	21.9	29.0	35.2	40.7
		9	160	22.2	8.24	10.1	10.7	15.6	21.8	28.1	32.5	38.5
		10	142	23.2	8.92	10.0	11.8	17.0	21.8	29.1	37.0	40.8
11		151	25.3	8.30	10.1	14.6	18.8	25.7	30.6	38.0	40.4	
12		185	25.9	7.81	10.1	16.1	20.1	25.6	31.8	36.1	41.6	
13		155	25.7	7.31	13.2	16.1	20.2	25.4	30.7	35.6	38.8	
14		151	25.5	7.34	10.5	15.6	21.0	24.8	30.2	35.6	40.2	
15		152	24.3	6.73	10.1	16.6	19.9	23.9	28.4	33.1	38.0	
16		157	22.7	7.48	10.1	11.5	17.3	22.9	28.6	32.6	36.2	
17		192	21.1	6.60	10.1	13.1	16.0	20.7	25.0	29.4	37.9	
18		156	23.2	6.09	11.5	15.5	19.7	22.7	26.4	30.9	35.4	
19		117	24.2	7.09	12.7	15.6	18.9	23.1	28.7	34.5	39.2	
20		97	24.7	6.48	12.5	15.7	20.2	24.8	28.7	33.0	39.1	
21		63	25.0	5.57	13.6	17.2	21.6	25.5	28.0	33.0	36.8	
22		32	24.3	6.54	12.7	17.4	19.7	23.7	27.4	33.5	36.3	

Table 3-2-3-7 Prevalence of underweight, normal weight, overweight and obesity in children and adolescents aged 6~22 in 2020

Age group (years)	M					F				
	n	Underweight	Normal	Overweight	Obese	n	Underweight	Normal	Overweight	Obese
6	238	16.0%	58.4%	11.3%	14.3%	171	8.8%	75.4%	6.4%	9.4%
7	238	14.3%	59.7%	10.9%	15.1%	172	12.2%	67.4%	12.8%	7.6%
8	257	12.5%	59.9%	15.2%	12.5%	157	12.1%	63.7%	12.7%	11.5%
9	188	7.4%	55.3%	16.5%	20.7%	160	13.8%	71.3%	7.5%	7.5%
10	198	8.5%	51.8%	22.1%	17.6%	142	8.5%	71.1%	9.2%	11.3%
11	180	10.6%	53.9%	15.0%	20.6%	151	7.9%	70.2%	9.9%	11.9%
12	207	13.0%	50.5%	20.7%	15.9%	185	4.3%	77.3%	9.7%	8.6%
6~12	1506	12.0%	56.0%	15.7%	16.3%	1138	9.6%	71.1%	9.8%	9.6%
13	200	12.0%	57.5%	18.0%	12.5%	155	3.9%	76.8%	14.8%	4.5%
14	186	15.1%	54.3%	19.4%	11.3%	151	8.6%	74.8%	10.6%	6.0%
15	169	12.4%	59.8%	19.5%	8.3%	152	9.2%	76.3%	9.9%	4.6%
16	174	20.7%	52.3%	14.4%	12.6%	158	14.6%	66.5%	14.6%	4.4%
17	184	15.8%	54.3%	17.4%	12.5%	200	10.5%	78.5%	4.5%	6.5%
18	163	16.0%	60.7%	16.6%	6.7%	156	10.3%	80.1%	7.1%	2.6%
13~18	1076	15.2%	56.4%	17.6%	10.8%	972	9.6%	75.6%	10.0%	4.8%
19	127	14.2%	54.3%	22.0%	9.4%	117	22.2%	60.7%	8.5%	8.5%
20	106	12.3%	53.8%	23.6%	10.4%	97	19.6%	63.9%	12.4%	4.1%
21	58	1.7%	53.4%	29.3%	15.5%	63	14.1%	75.0%	7.8%	3.1%
22	41	9.8%	53.7%	26.8%	9.8%	32	12.9%	74.2%	9.7%	3.2%
19~22	332	10.8%	53.9%	24.4%	10.8%	309	18.8%	66.0%	9.7%	5.5%
6~22 (Total)	2914	13.1%	55.9%	17.4%	13.6%	2419	10.7%	72.3%	9.8%	7.2%

Note: Criteria of underweight, overweight and obesity was referred to the BMI classification in the Health Industry Standards of People's Republic of China WS/T 586-2018 and WS/T 456-2014.

Table 3-2-3-8 Chest circumference (cm)

Gender	Age group (years)	n	Mean	SD	P ₃	P ₁₀	P ₂₅	P ₅₀	P ₇₅	P ₉₀	P ₉₇	
M	6	238	58.4	5.30	52.2	53.0	54.7	57.2	60.1	64.8	71.3	
	7	238	60.8	5.49	53.4	55.1	56.8	59.5	63.5	70.2	73.5	
	8	257	63.2	6.16	55.5	56.3	58.5	62.0	66.1	71.8	79.2	
	9	188	67.5	7.91	55.9	59.5	61.6	65.8	72.4	78.2	85.1	
	10	199	69.7	8.33	57.5	61.0	63.5	67.8	75.0	80.0	88.9	
	11	180	74.1	10.22	58.6	62.4	66.4	71.8	81.0	88.5	98.5	
	12	208	77.2	9.72	61.7	66.2	70.3	75.5	82.8	91.5	99.0	
	13	200	80.7	8.75	66.7	70.8	74.2	79.8	85.4	92.7	101.1	
	14	186	83.3	8.97	69.6	72.3	77.1	82.8	88.6	94.6	104.2	
	15	169	84.9	7.69	73.5	75.6	79.2	83.9	90.0	95.3	103.3	
	16	174	86.2	8.84	73.5	76.0	79.8	85.0	91.4	98.8	106.5	
	17	184	88.5	8.76	76.5	78.6	82.5	86.4	92.4	102.4	109.2	
	18	163	88.0	7.40	72.9	78.5	83.0	88.0	92.7	97.7	102.6	
	19	127	89.6	8.52	76.5	79.9	83.5	88.2	95.2	99.9	110.9	
	20	106	90.1	7.94	75.8	79.2	85.4	89.3	96.5	99.4	106.5	
	21	58	92.0	6.37	81.9	84.0	87.6	91.6	95.5	99.6	110.7	
	22	41	90.7	5.55	78.8	82.1	87.6	91.2	96.0	97.8	98.9	
	F	6	171	57.2	4.32	51.8	53.0	54.5	56.2	58.8	62.9	69.9
		7	172	59.8	5.21	52.4	54.3	56.5	59.2	62.0	66.3	73.8
		8	157	62.8	6.39	54.0	56.2	58.0	61.1	66.4	72.4	79.0
		9	160	65.3	6.76	55.3	58.0	60.6	64.7	69.2	73.0	81.8
		10	142	69.7	8.28	57.0	60.9	64.3	68.1	74.1	82.2	86.9
11		151	74.9	7.96	60.5	65.0	69.2	73.9	80.5	85.6	90.6	
12		185	77.3	7.30	64.2	69.0	72.3	76.0	81.4	88.4	93.9	
13		155	79.3	7.22	67.9	71.6	74.8	78.3	83.8	88.0	96.6	
14		151	81.0	6.98	69.8	73.0	76.0	80.0	84.5	91.2	96.7	
15		152	81.3	6.36	71.9	74.6	76.9	80.4	84.9	90.6	94.7	
16		158	82.2	6.84	71.3	73.9	77.1	81.4	86.5	91.7	98.0	
17		200	82.0	6.38	73.0	74.7	77.7	81.0	85.0	90.9	98.4	
18		156	82.7	5.87	74.6	76.6	78.4	82.0	84.7	90.0	97.0	
19		117	84.3	7.25	74.8	77.6	79.3	82.5	87.3	94.1	103.7	
20		97	84.6	7.14	74.2	76.9	79.5	84.0	87.3	94.6	107.0	
21		63	84.4	5.47	74.0	77.0	81.1	84.2	87.8	90.8	96.5	
22		32	83.6	7.28	72.2	76.2	77.7	82.3	86.5	92.9	96.7	

Table 3-2-3-9 Waist circumference (cm)

Gender	Age group (years)	n	Mean	SD	P ₃	P ₁₀	P ₂₅	P ₅₀	P ₇₅	P ₉₀	P ₉₇	
M	6	238	53.9	6.91	46.1	47.5	49.5	52.3	55.6	63.5	71.3	
	7	238	56.2	7.33	47.2	48.6	51.2	54.3	58.9	66.9	73.8	
	8	257	57.9	8.36	47.6	49.3	51.9	55.5	63.6	69.5	77.8	
	9	188	62.6	9.45	48.9	51.6	55.1	61.0	68.8	77.0	82.2	
	10	199	65.0	10.68	50.5	53.0	56.5	63.0	71.5	79.0	90.0	
	11	180	68.0	12.73	51.4	54.5	58.5	63.6	76.9	85.0	99.8	
	12	208	69.5	12.48	52.1	55.7	60.6	65.6	77.4	90.2	95.5	
	13	200	71.4	11.92	55.4	58.5	62.8	67.9	79.3	89.5	98.5	
	14	186	72.1	11.84	57.0	59.2	62.9	69.1	78.8	89.1	103.7	
	15	169	72.3	11.38	59.0	60.6	64.2	68.2	80.2	90.2	97.3	
	16	174	73.7	12.16	58.6	61.3	64.5	70.3	80.4	91.4	101.8	
	17	184	75.2	11.94	59.3	63.3	66.5	71.3	81.5	94.5	102.6	
	18	163	73.7	9.83	59.2	62.5	67.0	72.0	78.0	86.8	96.7	
	19	127	76.6	12.27	61.8	64.7	68.4	73.0	81.5	95.4	104.6	
	20	106	77.1	11.21	60.0	63.0	69.2	74.9	82.8	91.9	106.6	
	21	58	80.9	9.39	67.9	70.5	73.1	81.2	84.5	90.9	113.0	
	22	41	78.1	7.15	66.3	68.9	72.7	77.3	84.5	86.5	95.8	
	F	6	171	52.4	5.66	45.4	47.5	48.8	51.3	54.1	59.0	69.5
		7	172	54.5	6.57	46.0	48.0	50.0	53.0	56.5	64.2	73.4
		8	157	57.2	7.41	47.7	49.7	51.8	55.0	61.3	69.1	75.2
		9	160	58.6	7.33	47.0	50.5	54.0	57.0	62.9	68.1	74.2
		10	142	60.8	9.02	49.1	52.3	54.6	59.0	64.2	72.1	83.7
11		151	63.6	8.30	50.5	54.2	57.6	62.6	67.5	76.5	82.8	
12		185	66.0	8.49	53.2	57.2	59.9	64.5	70.2	77.3	84.3	
13		155	66.4	8.35	55.0	57.6	60.3	65.0	70.8	77.2	85.4	
14		151	67.9	8.44	55.8	58.9	61.5	66.6	72.2	80.2	88.3	
15		152	68.5	8.00	56.9	59.5	62.8	67.9	71.8	79.5	87.4	
16		158	69.6	8.66	56.3	60.3	63.5	67.5	75.5	80.5	90.9	
17		200	69.5	8.18	58.0	61.0	63.8	67.7	73.0	79.8	90.1	
18		156	69.1	7.05	59.5	62.2	64.3	68.1	72.1	78.0	86.9	
19		117	70.9	8.47	59.8	62.0	64.7	69.0	75.0	83.7	92.2	
20		97	71.1	8.67	60.0	62.2	64.5	69.7	75.1	81.3	95.8	
21		63	70.8	7.61	59.0	60.5	66.1	69.9	74.9	79.5	95.9	
22		32	70.3	8.80	58.7	60.9	63.5	68.9	74.9	80.4	96.8	

Table 3-2-3-10 Hip circumference (cm)

Gender	Age group (years)	n	Mean	SD	P ₃	P ₁₀	P ₂₅	P ₅₀	P ₇₅	P ₉₀	P ₉₇	
M	6	238	63.2	6.13	54.5	56.8	59.0	62.0	66.1	72.1	77.4	
	7	238	66.3	6.27	56.6	59.5	61.8	65.2	69.5	75.7	80.0	
	8	257	68.3	7.09	58.0	60.0	63.1	67.0	72.8	78.0	84.5	
	9	188	73.4	7.90	61.0	64.4	67.8	72.2	78.4	85.3	89.4	
	10	199	75.8	8.49	62.5	66.0	69.5	75.0	81.2	86.0	98.0	
	11	180	80.1	10.02	64.9	68.5	72.8	79.1	87.0	93.5	102.9	
	12	208	83.1	9.66	67.0	71.4	76.9	81.5	89.5	98.3	104.2	
	13	200	86.7	9.16	73.0	75.9	80.3	85.2	91.8	98.7	105.7	
	14	186	88.8	8.85	74.2	77.9	82.8	87.8	94.2	101.4	110.3	
	15	169	90.0	8.21	78.0	80.6	84.2	87.6	94.5	103.0	107.4	
	16	174	90.7	9.23	78.0	81.3	83.9	89.1	95.5	103.4	111.2	
	17	184	92.1	8.41	80.1	82.8	85.8	90.8	96.2	104.4	112.2	
	18	163	91.0	7.37	78.8	81.5	86.2	90.5	95.0	100.3	105.7	
	19	127	93.0	8.50	80.4	83.5	87.2	91.8	98.8	103.9	113.3	
	20	106	93.7	9.45	76.8	82.7	87.0	94.1	99.0	105.9	115.4	
	21	58	95.0	6.93	82.9	87.8	90.3	93.2	98.3	103.6	118.1	
	22	41	91.9	5.38	82.9	85.0	88.1	90.8	96.6	99.5	103.2	
	F	6	171	63.3	5.36	56.0	57.8	60.0	62.1	65.6	70.1	78.0
		7	172	66.6	5.87	57.5	59.9	62.4	66.0	69.6	74.0	80.2
		8	157	69.8	6.66	59.8	62.4	64.5	68.7	73.9	79.4	84.3
		9	160	72.8	6.61	61.8	64.6	68.0	72.0	76.5	81.5	87.3
		10	142	77.3	8.75	62.3	67.1	71.8	76.6	81.5	90.7	94.1
11		151	83.0	7.95	69.4	73.0	77.0	82.7	88.5	93.0	99.5	
12		185	85.8	7.12	73.3	77.6	80.4	85.4	89.5	95.7	100.4	
13		155	88.0	6.92	77.2	79.7	82.9	87.0	93.2	97.2	103.6	
14		151	90.2	7.38	78.0	81.0	84.5	90.0	94.5	100.2	107.3	
15		152	90.4	6.63	79.1	83.5	85.5	90.0	94.0	98.8	105.5	
16		158	91.7	7.33	77.5	82.9	87.4	90.6	96.7	101.5	106.4	
17		200	92.0	6.93	80.6	84.5	87.5	91.2	95.0	101.5	109.0	
18		156	92.2	6.12	82.8	86.0	88.5	91.4	95.0	99.5	107.5	
19		117	93.4	7.21	82.1	84.5	88.1	92.5	96.7	104.2	110.1	
20		97	93.8	6.31	82.5	86.4	89.6	93.1	97.8	102.0	108.6	
21		63	93.9	6.05	82.5	86.5	89.7	93.7	97.0	101.0	107.3	
22		32	93.3	8.25	83.6	84.8	87.4	92.1	95.8	103.7	107.8	

Table 3-2-3-11 Waist to Hip Ratio (WHR)

Gender	Age group (years)	n	Mean	SD	P ₃	P ₁₀	P ₂₅	P ₅₀	P ₇₅	P ₉₀	P ₉₇	
M	6	238	0.853	0.048	0.777	0.799	0.819	0.847	0.878	0.909	0.975	
	7	238	0.846	0.049	0.765	0.794	0.813	0.843	0.868	0.907	0.954	
	8	257	0.846	0.050	0.764	0.794	0.811	0.838	0.875	0.912	0.963	
	9	188	0.851	0.072	0.763	0.780	0.803	0.842	0.881	0.927	0.987	
	10	199	0.853	0.062	0.757	0.778	0.807	0.848	0.891	0.935	0.963	
	11	180	0.844	0.062	0.742	0.772	0.794	0.834	0.892	0.929	0.980	
	12	208	0.832	0.067	0.728	0.746	0.778	0.818	0.884	0.923	0.975	
	13	200	0.820	0.061	0.736	0.753	0.772	0.808	0.860	0.902	0.949	
	14	186	0.808	0.061	0.717	0.737	0.765	0.799	0.844	0.896	0.947	
	15	169	0.800	0.059	0.717	0.736	0.753	0.785	0.836	0.884	0.928	
	16	174	0.809	0.067	0.726	0.744	0.761	0.787	0.848	0.898	0.939	
	17	184	0.813	0.064	0.723	0.743	0.767	0.803	0.840	0.917	0.945	
	18	163	0.807	0.052	0.731	0.750	0.770	0.800	0.838	0.877	0.922	
	19	127	0.820	0.063	0.729	0.757	0.780	0.804	0.855	0.908	0.945	
	20	106	0.821	0.057	0.736	0.756	0.784	0.813	0.846	0.896	0.952	
	21	58	0.850	0.048	0.764	0.783	0.817	0.847	0.880	0.917	0.955	
	22	41	0.848	0.040	0.770	0.801	0.822	0.840	0.880	0.889	0.957	
	F	6	171	0.828	0.050	0.732	0.770	0.798	0.827	0.857	0.890	0.936
		7	172	0.818	0.051	0.736	0.761	0.787	0.808	0.846	0.888	0.927
		8	157	0.818	0.050	0.731	0.767	0.785	0.809	0.843	0.889	0.940
		9	160	0.803	0.051	0.713	0.742	0.767	0.802	0.839	0.874	0.911
		10	142	0.786	0.058	0.708	0.730	0.749	0.775	0.809	0.858	0.912
11		151	0.764	0.049	0.688	0.707	0.732	0.756	0.791	0.827	0.873	
12		185	0.767	0.056	0.683	0.704	0.728	0.764	0.795	0.830	0.889	
13		155	0.754	0.054	0.672	0.694	0.720	0.745	0.780	0.820	0.887	
14		151	0.751	0.050	0.672	0.699	0.724	0.747	0.776	0.818	0.859	
15		152	0.756	0.052	0.682	0.698	0.723	0.752	0.780	0.829	0.876	
16		158	0.758	0.055	0.678	0.697	0.720	0.750	0.787	0.827	0.869	
17		200	0.755	0.059	0.674	0.693	0.721	0.747	0.782	0.813	0.878	
18		156	0.749	0.043	0.682	0.702	0.721	0.743	0.768	0.806	0.842	
19		117	0.757	0.049	0.679	0.703	0.724	0.753	0.779	0.824	0.847	
20		97	0.756	0.054	0.686	0.704	0.718	0.751	0.776	0.819	0.901	
21		63	0.753	0.048	0.681	0.695	0.711	0.751	0.781	0.820	0.859	
22		32	0.753	0.050	0.664	0.686	0.719	0.756	0.774	0.844	0.897	

Table 3-2-3-12 Shoulder width (cm)

Gender	Age group (years)	n	Mean	SD	P ₃	P ₁₀	P ₂₅	P ₅₀	P ₇₅	P ₉₀	P ₉₇	
M	6	238	26.2	1.64	23.2	24.1	25.0	26.2	27.4	28.1	29.0	
	7	238	27.3	1.73	24.1	25.2	26.3	27.3	28.3	29.5	30.5	
	8	257	28.5	1.66	25.5	26.5	27.5	28.5	29.5	30.5	31.4	
	9	188	29.8	1.88	26.8	27.5	28.5	29.9	31.0	32.2	33.0	
	10	199	30.8	1.83	27.8	28.5	29.5	30.6	32.0	33.2	34.4	
	11	180	32.4	2.39	28.4	29.5	30.9	32.3	34.0	35.7	36.8	
	12	208	34.3	2.52	29.7	31.5	32.5	34.2	36.0	37.7	39.0	
	13	200	35.9	2.32	31.5	32.6	34.4	35.8	37.2	38.7	40.6	
	14	186	37.1	2.16	33.2	34.2	35.5	37.5	38.6	39.6	41.6	
	15	169	38.4	1.96	34.9	35.7	37.2	38.5	39.7	40.7	42.1	
	16	174	38.9	1.89	34.9	36.5	37.7	39.0	40.1	41.3	42.6	
	17	184	39.3	1.90	35.2	37.0	37.9	39.5	40.6	41.5	42.7	
	18	163	39.2	2.21	35.4	36.9	38.1	39.2	40.6	42.0	42.6	
	19	127	39.3	2.31	34.6	36.7	38.2	39.6	40.6	42.0	42.9	
	20	106	39.5	1.64	36.0	37.4	38.5	39.5	40.5	41.8	42.6	
	21	58	39.0	2.25	32.1	36.9	38.0	39.0	40.0	41.8	43.4	
	22	41	39.6	1.90	34.4	36.8	38.7	39.7	40.3	41.6	44.1	
	F	6	171	25.8	1.82	23.1	24.0	25.0	26.0	26.7	27.7	28.7
		7	172	27.2	1.75	24.1	25.2	26.3	27.1	28.1	29.2	30.7
		8	157	28.5	1.74	25.6	26.8	27.4	28.4	29.7	30.8	31.9
		9	160	29.6	2.25	25.3	27.5	28.4	29.7	30.9	32.0	33.1
		10	142	31.0	2.32	27.2	28.1	29.6	31.1	32.2	34.0	34.9
11		151	32.5	2.00	28.4	30.0	31.3	32.7	33.7	34.7	35.4	
12		185	33.5	1.84	29.4	31.4	32.5	33.7	34.7	35.5	36.2	
13		155	34.4	1.82	31.3	32.2	33.2	34.6	35.5	36.6	37.8	
14		151	34.8	1.70	31.6	32.5	33.7	34.9	36.0	37.2	37.9	
15		152	35.0	1.67	32.1	32.9	33.7	35.0	36.4	36.9	38.0	
16		158	35.2	1.50	32.0	33.4	34.2	35.2	36.1	37.0	38.2	
17		200	35.4	1.54	31.6	33.5	34.5	35.5	36.4	37.2	38.2	
18		156	35.4	1.82	31.2	33.5	34.5	35.4	36.7	37.5	38.4	
19		117	35.7	1.63	32.6	33.7	34.6	35.7	36.7	37.7	39.2	
20		97	35.7	2.18	28.2	33.7	35.0	35.7	37.0	38.2	38.7	
21		63	35.3	1.97	27.9	33.2	34.8	35.5	36.6	37.5	38.6	
22		32	35.3	3.30	23.9	32.9	34.2	35.7	36.9	38.1	38.6	

Table 3-2-3-13 Pelvis width (cm)

Gender	Age group (years)	n	Mean	SD	P ₃	P ₁₀	P ₂₅	P ₅₀	P ₇₅	P ₉₀	P ₉₇	
M	6	238	19.2	1.34	17.0	17.5	18.2	19.1	19.9	20.8	22.1	
	7	238	19.9	1.33	17.7	18.2	19.0	19.7	20.7	21.7	22.4	
	8	257	20.4	1.58	18.0	18.5	19.5	20.3	21.1	22.3	23.6	
	9	188	21.7	1.93	18.1	19.5	20.5	21.5	23.0	24.1	25.2	
	10	199	22.2	1.82	19.5	20.2	20.8	22.0	23.4	24.7	26.5	
	11	180	23.5	2.50	19.9	20.5	21.6	23.0	25.0	26.9	29.0	
	12	208	24.6	2.15	20.5	22.0	23.0	24.5	26.0	27.3	29.4	
	13	200	25.7	2.11	21.7	23.1	24.2	25.6	26.8	28.3	29.8	
	14	186	26.3	2.04	22.9	23.8	24.8	26.0	27.6	28.6	30.9	
	15	169	27.1	2.07	23.6	24.8	25.8	27.0	28.1	29.6	31.5	
	16	174	27.5	2.09	24.0	25.1	26.1	27.4	28.7	30.5	32.0	
	17	184	27.7	2.39	23.6	25.0	26.2	27.6	29.0	30.2	33.3	
	18	163	27.4	1.81	24.0	25.0	26.1	27.5	28.5	29.5	30.6	
	19	127	27.6	2.12	24.3	25.1	26.2	27.5	28.7	30.2	32.5	
	20	106	27.4	2.07	23.7	25.0	26.2	27.3	28.9	29.7	31.9	
	21	58	27.9	1.49	25.4	26.1	26.7	27.8	28.9	29.7	31.5	
	22	41	27.3	1.25	25.2	25.6	26.5	27.1	28.2	29.5	30.0	
	F	6	171	19.0	1.39	16.3	17.2	18.3	19.1	19.8	20.7	22.0
		7	172	19.8	1.59	17.5	18.1	18.8	19.8	20.5	21.5	23.3
		8	157	20.8	1.56	18.2	19.1	19.8	20.7	21.5	23.0	24.1
		9	160	22.0	2.37	19.0	19.8	20.7	21.8	22.7	24.0	26.1
		10	142	23.2	2.10	19.1	20.8	21.8	23.0	24.5	25.9	27.7
11		151	24.3	1.98	20.9	21.9	23.0	24.1	25.6	26.8	28.7	
12		185	25.2	1.66	21.7	23.2	24.3	25.2	26.2	27.4	28.7	
13		155	25.8	1.84	22.7	24.0	24.5	25.6	26.6	27.8	30.2	
14		151	26.5	1.69	23.4	24.2	25.2	26.5	27.6	28.6	29.7	
15		152	26.9	1.76	24.0	25.0	25.7	26.6	27.9	28.8	30.4	
16		158	26.7	1.74	23.6	24.6	25.6	26.6	27.7	29.1	30.5	
17		200	26.9	2.30	23.6	24.6	25.6	26.7	27.8	29.0	30.2	
18		156	27.1	1.94	24.2	25.0	26.0	26.8	28.0	29.1	31.0	
19		117	27.2	1.80	23.7	25.0	25.9	27.1	28.4	29.2	31.3	
20		97	27.6	2.21	24.6	25.3	26.4	27.2	28.3	30.0	32.1	
21		63	27.3	1.58	24.5	25.3	26.5	27.3	28.1	28.7	29.9	
22		32	27.8	2.16	24.0	24.9	26.5	27.5	29.0	31.6	31.7	

4. Physiological Function

Table 3-2-4-1 Resting pulse (bpm)

Gender	Age group (years)	n	Mean	SD	P ₃	P ₁₀	P ₂₅	P ₅₀	P ₇₅	P ₉₀	P ₉₇	
M	6	238	88.9	9.87	72.0	76.9	82.0	88.0	96.0	102.0	107.7	
	7	236	88.4	9.53	70.0	76.0	82.0	89.0	96.0	100.3	105.9	
	8	257	85.9	9.65	67.7	73.0	79.0	87.0	94.0	98.0	101.3	
	9	188	84.0	10.80	63.0	70.0	76.0	84.0	91.8	97.0	104.3	
	10	199	86.9	10.47	69.0	73.0	80.0	86.0	94.0	100.0	107.0	
	11	177	85.7	11.61	64.7	72.0	76.5	85.0	94.5	100.2	107.6	
	12	208	88.0	11.21	67.0	73.0	80.0	89.0	96.0	102.0	111.5	
	13	200	85.2	11.26	63.0	71.0	78.0	85.0	93.0	99.0	108.0	
	14	185	85.2	11.17	64.2	70.0	78.0	85.0	93.0	99.0	105.0	
	15	169	81.6	11.64	60.1	67.0	73.0	81.0	90.0	97.0	106.0	
	16	174	82.7	11.00	60.5	69.0	75.0	84.0	90.0	95.0	101.5	
	17	184	81.2	11.73	60.0	64.5	73.3	82.0	89.8	95.0	102.0	
	18	163	79.9	12.42	53.8	64.0	72.0	80.0	87.0	96.0	103.3	
	19	127	78.9	12.33	53.8	61.8	70.0	78.0	89.0	94.2	104.3	
	20	106	77.8	11.62	56.4	62.0	68.0	77.5	87.0	94.0	97.8	
	21	58	75.3	11.68	57.5	60.0	65.5	77.0	84.0	90.3	101.6	
	22	41	81.5	12.95	57.3	62.6	69.5	85.0	92.0	97.0	103.7	
	F	6	171	89.3	9.38	73.2	78.0	83.0	89.0	95.0	101.8	109.7
		7	172	87.9	10.13	67.0	75.0	81.0	88.0	95.0	100.0	107.0
		8	157	87.9	9.25	68.7	74.0	82.0	89.0	95.0	100.0	102.0
		9	160	84.0	10.69	63.8	69.0	76.0	85.0	92.0	98.0	102.0
		10	142	87.0	10.93	66.9	74.0	79.8	87.0	94.3	100.0	105.7
11		151	90.1	10.45	71.2	77.0	82.0	90.0	97.0	102.0	112.4	
12		185	87.9	10.14	67.2	75.6	82.0	87.0	95.0	101.0	107.8	
13		155	88.2	11.35	66.0	74.6	81.0	87.0	96.0	103.0	113.6	
14		151	85.0	9.86	67.6	72.0	78.0	84.0	92.0	98.0	105.0	
15		152	86.1	10.47	67.6	73.0	80.0	86.0	92.8	98.7	108.6	
16		158	86.7	11.71	62.3	72.0	78.8	87.0	95.0	101.0	109.0	
17		200	82.9	10.28	63.0	69.0	75.0	83.0	90.0	96.0	100.0	
18		156	83.3	11.34	59.4	69.7	76.0	84.0	90.8	95.0	104.3	
19		117	82.6	11.71	62.5	66.0	75.0	81.0	90.0	98.0	104.0	
20		97	82.5	11.84	59.0	64.0	75.0	84.0	89.5	95.4	103.5	
21		63	82.9	10.21	61.0	69.5	75.3	83.0	92.0	94.0	100.1	
22		32	77.9	9.72	61.0	63.3	71.0	79.0	85.0	92.1	101.8	

Table 3-2-4-2 Systolic blood pressure (mmHg)

Gender	Age group (years)	n	Mean	SD	P ₃	P ₁₀	P ₂₅	P ₅₀	P ₇₅	P ₉₀	P ₉₇	
M	6	238	100.9	9.47	85.2	87.0	94.0	101.0	107.0	114.0	117.8	
	7	238	103.9	11.06	82.2	88.9	97.0	105.0	113.0	118.0	122.8	
	8	257	105.0	10.63	84.7	92.0	98.0	104.0	112.0	119.0	126.3	
	9	188	106.8	11.12	86.7	93.8	99.0	105.0	114.0	122.1	129.7	
	10	199	105.0	11.41	85.0	90.0	97.0	104.0	114.0	121.0	126.0	
	11	180	108.1	12.19	89.4	93.1	98.3	108.0	116.8	124.9	132.1	
	12	208	112.2	12.61	88.0	96.0	104.0	111.0	121.0	129.0	137.0	
	13	200	116.9	11.02	94.0	102.1	109.3	118.0	125.0	130.9	136.0	
	14	186	119.5	11.11	97.6	104.0	114.0	120.0	127.3	133.0	137.0	
	15	169	122.0	10.91	100.2	107.0	114.5	123.0	130.0	135.0	139.9	
	16	174	124.2	11.54	103.0	108.5	116.0	125.0	132.3	139.5	143.0	
	17	184	125.4	10.30	105.1	112.5	119.0	125.0	132.0	138.0	146.4	
	18	163	124.1	9.98	103.8	111.0	118.0	124.0	130.0	138.0	145.0	
	19	127	122.6	10.59	100.7	108.8	114.0	125.0	130.0	134.2	142.2	
	20	106	123.2	11.65	104.0	109.7	114.8	124.0	132.0	138.0	145.0	
	21	58	122.5	10.14	99.5	109.2	115.8	124.5	130.0	132.3	140.0	
	22	41	125.2	11.35	100.5	110.2	120.0	125.0	130.5	139.6	151.0	
	F	6	171	100.1	10.01	79.2	86.0	94.0	101.0	107.0	112.0	118.0
		7	172	102.3	9.51	86.0	90.3	96.0	101.0	109.0	115.0	119.8
		8	157	105.5	10.54	87.7	91.8	97.0	106.0	113.5	120.0	125.8
		9	160	104.6	11.35	83.7	89.0	97.0	105.0	113.0	118.9	127.2
		10	142	104.6	11.24	84.0	89.6	97.0	104.0	111.5	120.0	127.7
11		151	107.6	10.37	91.0	94.0	100.0	107.0	116.0	121.8	128.0	
12		185	107.0	11.76	82.6	90.6	100.0	107.0	115.0	121.4	129.0	
13		155	109.6	10.72	91.7	95.6	103.0	109.0	117.0	124.0	132.3	
14		151	110.4	11.47	88.6	94.2	103.0	111.0	119.0	125.0	129.4	
15		152	111.9	10.80	92.6	97.3	104.0	112.0	120.0	126.0	131.4	
16		158	111.2	10.66	92.0	97.9	104.0	110.0	119.0	126.0	134.0	
17		200	110.6	10.04	93.0	98.0	103.0	110.0	118.0	123.9	130.9	
18		156	108.1	10.48	89.7	96.0	100.0	108.0	116.0	121.3	128.0	
19		117	108.2	10.42	90.0	93.0	101.0	109.0	115.0	122.2	128.5	
20		97	109.8	10.79	90.0	94.8	101.0	110.0	119.0	124.0	129.1	
21		63	111.2	13.72	87.8	91.0	100.0	110.0	121.5	129.0	134.9	
22		32	109.3	10.70	86.0	96.3	101.3	109.0	117.0	125.1	131.5	

Table 3-2-4-3 Diastolic blood pressure (mmHg)

Gender	Age group (years)	n	Mean	SD	P ₃	P ₁₀	P ₂₅	P ₅₀	P ₇₅	P ₉₀	P ₉₇	
M	6	238	62.1	9.34	44.2	50.9	56.0	62.0	68.0	74.0	81.8	
	7	238	62.7	9.05	46.2	51.0	56.0	62.0	69.0	74.1	79.0	
	8	257	62.5	8.92	46.7	51.8	56.0	63.0	68.0	73.0	80.0	
	9	188	66.7	9.38	47.0	55.0	60.0	67.0	74.0	78.0	82.0	
	10	199	65.4	9.70	48.0	53.0	58.0	65.0	72.0	79.0	85.0	
	11	180	67.3	9.16	51.4	56.0	61.0	66.0	73.0	79.0	88.0	
	12	208	67.4	8.95	50.0	55.9	62.0	66.5	73.0	79.0	85.0	
	13	200	69.2	8.50	55.0	58.1	63.0	69.0	75.0	81.0	86.0	
	14	186	70.9	7.58	55.8	62.0	66.0	71.0	75.3	81.0	84.4	
	15	169	71.4	8.30	54.1	61.0	66.0	72.0	76.0	81.0	86.0	
	16	174	73.2	8.18	57.3	62.0	68.0	74.0	79.0	83.5	87.0	
	17	184	73.2	8.28	56.7	62.0	68.0	73.0	79.0	84.0	89.0	
	18	163	70.5	8.28	54.9	59.0	65.0	70.0	77.0	81.6	86.1	
	19	127	70.6	8.84	53.8	59.0	64.0	71.0	77.0	82.2	85.0	
	20	106	70.2	8.95	54.2	57.7	63.0	71.0	77.0	81.3	87.6	
	21	58	71.1	8.05	58.3	61.9	64.0	70.0	78.0	82.1	86.5	
	22	41	71.5	9.07	50.6	59.2	66.0	70.0	79.0	81.8	90.2	
	F	6	171	63.2	8.69	47.2	52.2	57.0	63.0	69.0	74.8	79.8
		7	172	64.6	8.48	50.0	54.0	59.0	64.0	70.0	77.0	81.8
		8	157	65.8	8.51	50.7	56.0	59.0	66.0	71.0	77.0	85.0
		9	160	65.6	9.40	47.0	55.0	59.0	65.0	72.0	79.0	83.2
		10	142	65.9	8.51	51.0	55.0	59.0	66.0	72.3	77.7	80.7
11		151	68.6	8.30	54.0	58.0	63.0	68.0	75.0	80.0	83.9	
12		185	67.4	9.39	48.6	54.0	62.0	68.0	73.0	78.4	87.0	
13		155	69.7	9.21	51.4	58.0	63.0	69.0	77.0	82.0	87.3	
14		151	69.8	8.13	56.0	59.0	64.0	69.0	76.0	80.8	85.4	
15		152	70.1	8.69	53.8	59.0	64.0	70.0	76.0	82.0	86.0	
16		158	70.9	8.24	54.8	59.9	66.0	71.0	77.0	81.0	86.0	
17		200	70.5	8.44	56.0	60.0	64.3	71.0	77.0	81.0	87.0	
18		156	69.1	9.17	52.7	58.0	62.0	69.0	76.0	82.3	87.0	
19		117	68.6	8.55	51.5	57.8	63.0	69.0	73.5	80.4	84.9	
20		97	68.3	9.05	48.0	57.8	63.0	68.0	74.0	80.2	83.1	
21		63	67.8	10.38	50.9	54.5	62.0	66.0	73.8	79.0	89.1	
22		32	67.9	7.64	52.0	60.0	61.3	66.0	73.8	78.7	87.9	

Table 3-2-4-4 Pressure difference (mmHg)

Gender	Age group (years)	n	Mean	SD	P ₃	P ₁₀	P ₂₅	P ₅₀	P ₇₅	P ₉₀	P ₉₇	
M	6	238	38.7	8.57	23.2	28.0	33.0	38.0	44.0	50.1	55.8	
	7	238	41.2	8.95	24.0	30.9	35.0	41.0	48.0	52.1	57.8	
	8	257	42.4	9.49	26.7	30.0	36.0	43.0	48.0	54.2	64.5	
	9	188	40.1	10.30	24.0	27.0	33.0	39.5	46.8	54.0	60.0	
	10	199	39.6	9.94	24.0	28.0	32.0	39.0	46.0	54.0	59.0	
	11	180	40.8	9.36	26.4	29.1	34.0	39.0	46.8	54.0	63.6	
	12	208	44.8	9.82	28.0	33.0	38.0	44.0	52.0	59.0	63.7	
	13	200	47.7	9.69	31.0	36.1	40.0	47.0	54.0	60.0	68.0	
	14	186	48.6	10.08	27.0	36.0	42.0	49.0	55.0	60.3	69.8	
	15	169	50.6	9.83	31.1	37.0	44.5	51.0	57.0	64.0	68.9	
	16	174	51.0	10.51	31.0	37.5	44.0	51.0	58.0	65.0	72.8	
	17	184	52.2	10.03	33.6	40.5	46.0	51.0	59.0	65.5	73.5	
	18	163	53.6	10.63	33.9	39.0	46.0	54.0	61.0	67.6	75.1	
	19	127	52.0	9.79	33.8	40.0	46.0	52.0	58.0	64.2	72.3	
	20	106	53.0	10.53	32.2	38.0	45.8	54.0	61.0	67.0	70.0	
	21	58	51.4	9.36	26.6	38.0	44.8	52.0	59.0	62.0	64.5	
	22	41	53.7	10.34	35.8	41.2	45.0	52.0	61.5	67.8	75.5	
	F	6	171	36.9	7.82	23.2	27.2	32.0	36.0	42.0	48.0	54.0
		7	172	37.7	8.51	22.2	26.3	31.0	38.0	43.0	47.7	54.6
		8	157	39.7	9.02	24.5	28.0	33.5	40.0	45.0	51.0	58.8
		9	160	38.9	9.01	23.0	28.0	31.3	38.5	45.8	51.0	54.0
		10	142	38.8	8.05	26.3	29.0	33.0	38.0	45.0	49.0	55.8
11		151	39.0	8.35	25.6	29.0	33.0	37.0	45.0	49.0	56.4	
12		185	39.6	8.49	24.0	29.0	33.0	40.0	45.5	50.0	54.4	
13		155	40.0	8.30	25.0	29.0	34.0	40.0	44.0	50.4	58.6	
14		151	40.5	8.20	26.6	30.2	35.0	40.0	46.0	50.8	57.4	
15		152	41.8	8.98	27.0	31.0	35.0	41.0	47.8	53.7	59.4	
16		158	40.3	8.50	25.0	29.0	34.8	39.0	47.0	52.1	57.2	
17		200	40.0	7.68	26.0	31.0	35.0	40.0	45.0	49.0	54.0	
18		156	39.1	8.70	25.0	29.0	34.0	39.0	44.0	51.0	60.0	
19		117	39.7	8.60	25.1	29.0	33.0	39.0	45.5	51.2	58.9	
20		97	41.5	8.01	25.9	31.0	36.0	41.0	47.0	50.4	58.1	
21		63	43.6	9.06	27.8	32.0	36.0	44.0	50.0	55.0	62.0	
22		32	41.4	9.97	22.0	29.2	34.3	40.0	50.5	57.0	64.2	

Table 3-2-4-5 Vital capacity (ml)

Gender	Age group (years)	n	Mean	SD	P ₃	P ₁₀	P ₂₅	P ₅₀	P ₇₅	P ₉₀	P ₉₇	
M	6	236	915.7	287.09	493.2	588.3	687.3	885.0	1100.3	1277.2	1549.9	
	7	237	1112.0	350.82	513.7	607.2	817.0	1132.0	1347.0	1529.6	1839.0	
	8	257	1447.6	325.89	727.4	1066.6	1245.0	1450.0	1642.0	1830.0	2035.8	
	9	188	1666.9	342.48	1090.4	1223.1	1403.3	1654.5	1869.3	2173.2	2388.8	
	10	199	1848.4	386.88	1126.0	1335.0	1551.0	1830.0	2106.0	2361.0	2585.0	
	11	180	2135.7	540.56	1120.2	1364.9	1784.3	2174.5	2486.8	2817.4	3138.1	
	12	208	2571.1	661.27	1222.6	1747.6	2123.8	2531.5	2979.0	3333.2	3896.4	
	13	200	3005.2	674.24	1749.5	2181.1	2587.3	2987.0	3441.8	3856.6	4364.0	
	14	186	3317.9	729.43	2032.2	2439.8	2795.5	3211.5	3825.8	4323.8	4850.0	
	15	169	3534.4	683.24	2315.0	2681.0	3024.5	3483.0	4007.0	4413.0	5059.4	
	16	174	3547.6	677.23	2270.0	2700.0	3141.0	3576.0	4001.0	4349.5	4943.3	
	17	184	3697.7	731.58	2245.6	2713.0	3227.0	3691.5	4216.5	4566.0	5187.9	
	18	163	3891.9	736.47	2411.9	3031.6	3423.0	3852.0	4310.0	4916.0	5499.1	
	19	127	3868.6	740.13	2372.1	2921.8	3317.0	3879.0	4416.0	4769.0	5236.1	
	20	105	4069.8	787.19	2878.3	3150.8	3481.0	4073.0	4546.0	5139.6	5502.7	
	21	58	3918.4	699.52	2655.1	2838.0	3260.0	4014.0	4471.3	4844.0	5021.0	
	22	41	4163.1	654.08	2996.8	3095.4	3573.0	4277.0	4704.0	5011.2	5223.4	
	F	6	171	858.9	248.80	473.6	533.2	652.0	827.0	1030.0	1167.8	1374.0
		7	171	1081.7	305.10	504.3	608.6	898.0	1102.0	1275.0	1452.0	1635.0
		8	157	1319.6	284.79	781.0	1024.6	1134.5	1299.0	1473.5	1694.8	1926.0
		9	160	1492.6	361.72	795.3	1033.4	1244.0	1486.0	1715.3	1966.3	2206.6
		10	142	1790.4	355.16	1119.2	1281.5	1539.5	1800.5	2018.3	2220.0	2554.3
11		151	2055.8	486.69	1199.6	1426.6	1711.0	2080.0	2330.0	2613.0	2968.9	
12		184	2337.0	495.52	1625.5	1807.5	2055.0	2290.5	2586.3	2845.5	3107.2	
13		155	2418.6	476.97	1392.7	1910.0	2122.0	2405.0	2750.0	2952.0	3354.8	
14		151	2509.0	478.46	1648.4	2014.2	2157.0	2408.0	2823.0	3188.0	3385.8	
15		152	2583.4	410.34	1854.5	2133.6	2295.3	2531.0	2860.8	3171.1	3382.6	
16		158	2653.6	471.39	1837.4	2159.7	2341.8	2573.0	2936.3	3285.5	3778.2	
17		200	2706.1	489.04	1934.7	2086.2	2381.0	2683.5	3013.8	3339.0	3694.8	
18		156	2657.8	541.92	1802.9	2103.0	2247.0	2589.0	2964.8	3461.0	3802.1	
19		117	2738.7	584.96	1685.0	2072.0	2353.0	2735.0	3056.5	3510.2	4079.4	
20		97	2806.0	506.90	2010.3	2193.8	2397.0	2740.0	3125.5	3606.0	3929.3	
21		63	2799.1	443.20	2127.4	2284.0	2422.3	2793.0	3066.5	3433.0	3862.1	
22		32	2781.8	516.07	1925.0	2118.7	2388.8	2749.5	3011.3	3658.4	3972.6	

Table 3-2-4-6 Vital capacity/weight (ml/kg)

Gender	Age group (years)	n	Mean	SD	P ₃	P ₁₀	P ₂₅	P ₅₀	P ₇₅	P ₉₀	P ₉₇	
M	6	236	40.7	12.54	19.7	25.3	32.4	39.2	48.6	57.9	66.0	
	7	237	44.0	14.05	17.5	26.7	33.2	43.4	53.6	63.3	71.1	
	8	257	51.5	12.95	24.4	35.6	42.7	51.6	60.5	67.7	76.5	
	9	188	50.7	12.42	30.5	34.1	41.3	51.6	59.0	66.8	74.4	
	10	199	50.0	11.97	27.2	36.5	41.9	50.0	57.0	66.6	72.8	
	11	180	49.9	13.32	25.3	33.5	40.9	49.2	57.9	68.2	77.0	
	12	208	53.8	13.45	28.9	35.2	44.3	54.8	63.0	69.5	81.1	
	13	200	56.2	13.26	32.3	38.8	47.4	55.7	65.1	74.4	81.5	
	14	186	58.1	13.05	31.6	40.8	49.1	58.6	67.0	76.3	82.3	
	15	169	58.8	11.81	38.3	43.1	50.0	58.5	67.3	74.8	80.5	
	16	174	56.8	11.76	36.4	42.5	48.2	56.2	65.4	72.2	80.5	
	17	184	57.8	12.71	32.7	41.3	48.1	58.3	67.0	73.3	84.6	
	18	163	61.1	11.29	39.5	44.9	53.5	61.5	70.0	74.7	80.2	
	19	127	57.8	11.81	33.1	42.1	50.7	58.3	66.3	73.1	77.9	
	20	105	60.4	10.75	39.9	46.3	52.7	59.9	67.0	76.2	82.6	
	21	58	55.9	10.52	35.3	39.1	49.4	56.9	61.9	70.7	78.3	
	22	41	62.6	12.18	36.0	43.9	56.0	63.1	68.9	82.5	88.3	
	F	6	171	40.4	12.29	21.6	24.6	30.9	39.7	49.0	56.7	61.9
		7	171	44.9	12.84	18.3	25.4	36.7	46.3	53.8	59.4	69.2
		8	157	47.8	11.68	26.0	33.7	40.3	47.1	54.7	62.4	71.9
		9	160	49.3	12.49	26.5	33.2	40.6	48.7	57.4	64.0	72.6
		10	142	50.2	10.45	32.5	36.6	42.2	49.6	58.0	65.2	68.8
11		151	49.7	12.51	28.4	34.7	42.6	48.5	56.5	64.9	80.7	
12		184	51.4	12.70	29.8	37.3	43.0	50.4	57.5	66.3	79.1	
13		155	50.0	10.45	27.3	37.9	43.6	50.7	55.9	62.0	74.1	
14		151	49.7	9.95	31.4	37.4	42.9	49.0	56.2	63.5	70.3	
15		152	50.6	10.12	30.4	37.9	43.5	49.7	57.7	64.4	69.1	
16		158	51.2	11.10	33.5	36.8	44.0	50.9	58.3	64.5	73.3	
17		200	52.1	10.31	34.3	41.1	45.3	51.7	58.4	65.9	73.9	
18		156	51.0	9.33	34.5	39.4	44.9	50.9	56.7	62.5	71.8	
19		117	51.2	10.92	29.3	38.1	44.1	50.8	58.2	63.1	74.8	
20		97	51.3	8.70	35.1	38.3	45.7	51.1	57.0	62.3	70.8	
21		63	51.3	8.03	37.7	40.9	44.9	50.0	57.2	63.4	67.5	
22		32	51.9	7.73	38.1	43.2	45.4	52.2	56.4	63.2	66.9	

5. Physical Fitness

Table 3-2-5-1 50m run (sec)

Gender	Age group (years)	n	Mean	SD	P ₃	P ₁₀	P ₂₅	P ₅₀	P ₇₅	P ₉₀	P ₉₇	
M	6	228	12.8	1.43	10.4	11.0	11.8	12.6	13.6	14.9	15.8	
	7	217	11.6	1.15	9.7	10.2	10.8	11.4	12.3	13.2	13.9	
	8	248	11.6	1.17	9.2	9.7	10.3	11.1	11.9	12.7	13.7	
	9	183	11.2	1.37	9.1	9.6	10.3	11.0	11.8	12.8	14.8	
	10	193	10.9	1.18	8.8	9.4	10.1	10.9	11.7	12.5	13.4	
	11	167	10.4	1.24	8.5	9.1	9.6	10.1	11.1	12.0	13.0	
	12	194	9.7	1.27	8.0	8.2	8.8	9.5	10.3	11.5	12.6	
	13	193	9.0	1.19	7.2	7.6	8.2	9.0	9.6	10.4	11.2	
	14	174	8.5	0.99	7.1	7.4	7.9	8.4	9.0	9.9	11.1	
	15	137	8.4	1.33	7.0	7.3	7.6	8.1	8.9	9.8	11.3	
	16	150	8.1	0.78	7.0	7.2	7.5	7.9	8.5	9.2	10.0	
	17	171	8.0	0.83	6.7	7.0	7.4	7.9	8.5	9.1	9.9	
	18	150	7.9	0.75	6.7	7.0	7.3	7.8	8.3	9.0	9.6	
	19	118	8.0	0.89	6.8	7.2	7.4	7.9	8.5	9.1	10.2	
	20	101	8.0	0.94	6.6	7.1	7.4	8.0	8.5	9.3	10.1	
	21	57	8.1	0.74	7.0	7.3	7.6	8.0	8.5	9.2	9.9	
	22	38	8.2	1.03	6.9	7.2	7.5	7.7	9.2	10.0	10.4	
	F	6	168	13.0	1.32	10.7	11.4	12.0	12.9	14.0	14.7	15.7
		7	163	12.2	1.27	10.4	10.8	11.4	12.1	12.8	13.9	15.2
		8	152	11.7	1.24	9.5	10.1	10.9	11.7	12.5	13.4	14.2
		9	156	11.4	1.02	9.2	10.1	10.8	11.5	12.0	12.8	13.6
		10	140	11.2	1.24	9.5	9.8	10.2	11.0	11.9	12.7	14.0
11		140	10.7	1.12	9.1	9.5	9.9	10.5	11.4	12.4	12.9	
12		175	10.0	0.98	8.4	8.8	9.2	9.9	10.6	11.4	12.1	
13		148	9.8	1.04	8.2	8.6	9.1	9.7	10.3	11.0	12.3	
14		142	9.9	0.90	8.3	8.8	9.2	9.8	10.5	11.2	11.9	
15		128	9.6	0.90	8.1	8.6	8.9	9.5	10.1	10.7	11.3	
16		137	9.8	0.90	8.3	8.7	9.2	9.7	10.3	10.9	11.5	
17		188	9.7	1.04	8.1	8.6	9.0	9.7	10.3	10.9	12.0	
18		143	9.9	1.14	8.1	8.6	9.2	9.8	10.5	11.3	12.0	
19		100	9.8	0.95	8.3	8.7	9.2	9.7	10.4	10.8	12.3	
20		82	9.8	0.97	8.5	8.9	9.1	9.7	10.4	10.9	11.7	
21		47	9.9	1.10	7.7	8.5	9.0	9.8	10.5	11.3	12.7	
22		27	10.2	1.19	8.2	8.6	9.3	10.1	10.8	11.9	12.4	

Table 3-2-5-2 Standing long jump (cm)

Gender	Age group (years)	n	Mean	SD	P ₃	P ₁₀	P ₂₅	P ₅₀	P ₇₅	P ₉₀	P ₉₇	
M	6	238	102.1	15.30	77.0	87.0	90.0	101.0	113.0	123.0	133.7	
	7	237	111.6	16.18	87.0	90.0	98.0	110.0	122.5	135.0	144.0	
	8	257	121.1	18.53	87.0	96.0	107.0	121.0	134.5	145.0	156.0	
	9	188	125.4	19.40	89.0	98.0	110.0	126.0	139.0	150.0	163.0	
	10	197	133.5	20.29	96.0	107.8	119.5	134.0	146.0	158.0	174.1	
	11	180	140.3	23.60	98.0	110.1	125.3	139.0	154.5	174.9	187.1	
	12	208	152.6	26.89	97.3	121.0	137.3	151.5	168.8	192.1	201.7	
	13	199	165.6	28.92	106.0	128.0	147.0	168.0	186.0	200.0	218.0	
	14	185	175.9	30.79	119.0	135.6	151.5	182.0	199.0	215.4	234.8	
	15	169	188.1	29.66	130.1	146.0	165.5	189.0	210.5	224.0	241.0	
	16	173	192.5	28.16	135.7	155.8	175.0	193.0	213.0	223.6	239.6	
	17	184	191.8	33.83	123.6	145.0	171.5	190.0	216.0	234.0	254.7	
	18	162	194.7	28.94	134.9	150.6	182.0	193.5	214.0	232.0	244.2	
	19	127	194.5	28.12	131.2	155.6	182.0	197.0	212.0	229.0	242.0	
	20	106	197.4	28.59	135.3	156.5	182.0	196.5	217.3	234.6	247.4	
	21	58	194.4	28.61	128.8	151.3	181.5	190.5	218.0	233.4	238.5	
	22	41	196.7	28.38	109.8	162.6	183.0	200.0	218.0	228.6	236.0	
	F	6	171	98.1	12.20	76.2	85.2	90.0	98.0	104.0	114.8	122.8
		7	172	105.7	13.33	87.0	87.0	94.3	105.0	116.8	122.7	134.6
		8	157	113.7	16.46	87.0	93.0	101.5	113.0	124.0	135.0	149.1
		9	160	120.9	16.49	90.8	102.0	108.3	119.0	132.8	142.8	153.0
		10	142	129.0	19.92	98.3	105.0	113.5	127.0	144.0	155.4	166.8
11		150	129.8	21.21	87.5	101.1	116.0	130.0	146.0	156.9	170.5	
12		185	136.7	22.37	91.6	110.0	121.0	137.0	155.0	167.0	178.5	
13		155	137.2	22.99	92.0	109.6	123.0	133.0	151.0	171.8	186.0	
14		150	137.1	22.55	95.1	109.0	117.0	137.0	152.5	168.9	181.0	
15		152	143.2	20.16	109.6	117.3	128.3	141.0	155.8	172.7	187.4	
16		158	144.9	21.86	104.5	120.0	128.0	144.0	159.0	171.4	189.5	
17		199	144.6	22.58	105.0	115.0	130.0	142.0	159.0	181.0	188.0	
18		155	140.9	23.08	103.0	110.0	126.0	139.0	155.0	171.8	193.0	
19		116	143.3	23.74	102.0	113.0	125.0	142.0	158.8	182.0	188.0	
20		96	139.6	23.77	102.8	112.0	121.3	138.0	155.0	175.6	188.5	
21		63	145.9	30.91	87.0	109.0	123.0	145.0	179.0	186.4	199.5	
22		30	145.1	30.33	90.0	105.0	120.5	138.5	175.3	182.0	193.5	

Table 3-2-5-3 Vertical jump (cm)

Gender	Age group (years)	n	Mean	SD	P ₃	P ₁₀	P ₂₅	P ₅₀	P ₇₅	P ₉₀	P ₉₇	
M	6	238	18.7	3.52	12.1	14.2	16.2	18.9	21.1	22.8	25.2	
	7	236	21.1	3.38	14.7	17.1	18.9	21.0	23.1	25.4	28.0	
	8	257	22.9	4.23	14.9	18.0	19.9	22.6	25.7	28.5	31.1	
	9	188	23.4	4.51	15.8	17.8	20.3	23.1	26.3	29.5	33.3	
	10	198	24.8	5.19	15.2	19.2	21.1	25.0	27.6	31.3	35.7	
	11	180	26.7	5.81	15.6	20.1	23.0	26.3	30.2	34.2	39.2	
	12	208	29.0	6.80	17.9	20.3	24.0	28.4	33.9	37.7	42.8	
	13	199	33.2	7.71	20.3	23.4	27.9	33.1	38.2	44.0	49.8	
	14	185	35.7	9.18	20.0	25.1	28.8	34.9	40.8	49.1	53.9	
	15	169	39.2	8.63	23.3	29.3	33.2	38.9	44.3	50.7	56.6	
	16	173	41.2	8.23	25.7	30.7	36.6	40.9	46.7	52.3	58.1	
	17	184	40.8	8.63	24.2	29.5	35.1	40.6	46.6	52.0	58.1	
	18	162	40.8	8.58	24.2	30.1	35.7	40.2	45.5	52.2	59.2	
	19	125	40.5	8.79	24.0	29.2	34.0	40.7	46.2	52.0	58.8	
	20	105	39.9	8.48	25.9	28.9	34.4	38.7	46.1	51.9	58.4	
	21	57	37.4	7.45	23.3	27.9	32.2	36.0	42.6	48.7	52.2	
	22	40	38.2	8.31	22.7	27.0	31.0	38.2	43.6	49.4	57.6	
	F	6	171	18.4	3.23	12.8	14.4	16.0	18.2	20.4	22.1	24.6
		7	172	20.2	3.27	13.8	15.9	17.9	20.2	22.3	24.1	27.2
		8	157	21.9	3.93	14.8	17.3	19.3	21.5	23.9	27.1	30.8
		9	160	22.4	4.23	14.5	17.6	19.6	21.8	25.4	27.8	32.3
		10	142	23.3	4.06	15.5	17.3	20.8	23.2	26.4	28.2	31.5
11		151	24.6	5.02	16.2	18.9	21.1	24.0	28.2	31.1	34.9	
12		185	25.3	5.16	16.3	18.5	21.7	25.1	29.0	32.6	35.8	
13		155	26.2	5.16	16.7	18.6	23.1	26.1	29.7	32.5	36.5	
14		151	25.6	5.09	18.3	19.8	21.7	24.6	29.3	32.5	36.1	
15		152	26.0	5.48	17.6	20.2	22.8	25.1	28.8	33.1	39.6	
16		158	26.0	5.35	16.6	19.3	22.2	26.0	29.4	32.7	37.2	
17		199	27.6	5.74	18.3	21.1	23.4	26.9	31.3	34.7	41.2	
18		155	26.5	5.33	17.8	19.8	23.0	25.5	29.7	33.8	38.3	
19		116	25.1	4.87	15.8	19.7	22.3	25.0	28.0	31.1	35.5	
20		96	25.4	5.73	16.6	18.8	20.9	24.9	28.0	33.6	40.1	
21		63	26.1	6.70	14.7	16.9	21.3	25.6	29.6	35.8	43.6	
22		31	25.6	6.12	15.4	17.6	21.2	25.1	28.4	35.4	42.5	

Table 3-2-5-4 Inclined pull-ups / Pull-ups / One-minute sit-ups (times)

Gender	Age group (years)	n	Mean	SD	P ₃	P ₁₀	P ₂₅	P ₅₀	P ₇₅	P ₉₀	P ₉₇	
M	6	238	10.7	4.71	2.0	5.0	8.0	10.0	14.0	17.0	20.0	
	7	238	10.8	5.82	2.0	5.0	7.0	10.0	14.0	17.1	26.0	
	8	257	10.8	5.18	2.0	5.0	7.0	11.0	14.0	15.0	23.3	
	9	188	11.2	6.79	0.0	4.9	7.0	10.0	14.0	19.1	28.0	
	10	199	12.2	6.82	2.0	6.0	8.0	11.0	14.0	20.0	29.0	
	11	180	11.9	5.62	0.0	6.0	8.0	11.0	15.0	20.0	25.0	
	12	208	12.6	7.29	0.0	4.9	8.0	11.0	15.0	22.2	28.0	
	13	200	0.6	1.56	0.0	0.0	0.0	0.0	0.0	2.0	4.0	
	14	186	0.7	1.49	0.0	0.0	0.0	0.0	1.0	2.0	5.0	
	15	169	1.3	2.10	0.0	0.0	0.0	0.0	2.0	4.0	7.9	
	16	174	1.3	2.07	0.0	0.0	0.0	0.0	2.0	4.0	8.0	
	17	184	1.6	2.57	0.0	0.0	0.0	0.0	2.8	5.0	9.5	
	18	163	1.8	2.29	0.0	0.0	0.0	1.0	2.0	5.0	8.2	
	19	127	2.5	2.36	0.0	1.0	1.0	1.0	4.0	6.0	9.2	
	20	106	3.1	2.97	1.0	1.0	1.0	2.0	5.0	8.0	11.0	
	21	58	2.5	2.23	0.0	1.0	1.0	2.0	3.3	6.0	8.7	
	22	41	2.6	2.69	0.0	0.0	0.0	2.0	5.0	6.8	9.5	
	F	6	171	11.8	8.05	0.0	0.0	4.0	13.0	18.0	22.8	26.0
		7	171	17.4	6.86	3.0	9.0	13.0	18.0	22.0	26.0	30.0
		8	155	19.0	7.60	3.7	9.2	14.0	20.0	24.0	29.0	32.0
		9	159	20.8	7.51	2.8	13.0	17.0	21.0	25.0	29.0	34.4
		10	142	23.7	6.87	9.6	15.0	19.0	24.0	28.0	32.7	37.7
11		150	24.1	6.18	10.1	16.0	21.0	24.0	27.3	32.0	36.0	
12		185	25.7	7.50	11.2	16.6	21.0	25.0	31.0	34.0	39.4	
13		154	27.9	7.06	14.0	20.5	24.0	27.0	33.0	37.0	43.0	
14		150	28.1	8.18	7.5	19.0	23.0	29.0	33.0	38.0	42.5	
15		150	28.9	7.66	13.5	20.1	24.8	28.0	33.0	40.0	45.0	
16		158	28.0	8.74	8.5	18.0	23.0	28.0	34.0	40.0	45.0	
17		199	29.1	8.79	10.0	18.0	23.0	30.0	34.0	40.0	45.0	
18		155	28.3	8.90	10.0	17.0	22.0	28.0	35.0	40.0	43.0	
19		117	24.0	8.54	5.2	14.8	18.0	24.0	29.0	36.0	40.9	
20		94	26.3	8.97	7.7	14.0	20.0	26.5	32.3	38.5	45.3	
21		62	27.4	9.45	2.8	13.8	22.8	28.0	33.3	39.0	43.3	
22	32	24.4	9.49	8.0	12.3	15.0	26.0	31.0	36.0	43.4		

Note: Inclined pull-ups for males aged 6~12; pull-ups for males aged 13~22; sit-ups for females aged 6~22.

Table 3-2-5-5 Grip strength (kg)

Gender	Age group (years)	n	Mean	SD	P ₃	P ₁₀	P ₂₅	P ₅₀	P ₇₅	P ₉₀	P ₉₇	
M	6	238	7.8	2.19	4.4	4.8	6.4	7.7	9.2	10.5	12.3	
	7	238	9.2	2.32	5.4	6.3	7.5	9.0	10.5	12.0	14.6	
	8	257	10.9	2.68	6.7	7.6	8.9	10.8	12.4	14.2	16.5	
	9	188	13.3	3.51	7.1	9.1	11.0	13.1	15.4	17.6	21.3	
	10	199	15.3	4.02	8.6	10.6	12.6	14.7	17.6	20.1	23.9	
	11	180	17.8	5.05	9.8	11.5	13.8	17.3	20.7	24.6	29.3	
	12	208	20.6	6.08	10.4	13.5	16.2	19.7	25.0	28.7	32.9	
	13	200	25.9	6.83	14.3	17.0	21.0	26.1	30.5	34.1	38.5	
	14	186	28.4	7.00	16.8	20.1	23.5	28.1	32.6	37.7	43.6	
	15	169	32.6	6.95	20.1	24.3	28.0	32.4	36.4	41.2	48.1	
	16	174	34.4	6.90	22.8	25.9	29.4	33.4	38.7	44.5	48.9	
	17	184	35.1	8.34	19.9	25.1	29.6	34.7	40.1	46.1	51.8	
	18	163	37.0	7.44	23.5	28.0	31.6	37.2	41.8	47.3	52.2	
	19	127	37.6	7.99	23.1	27.7	32.1	37.0	42.3	49.3	53.7	
	20	106	37.7	7.46	25.4	28.7	32.9	37.3	40.6	48.7	54.0	
	21	58	39.8	8.02	25.3	31.0	34.4	38.2	44.4	50.6	60.2	
	22	41	40.4	6.59	26.3	33.9	35.4	39.9	45.6	49.7	52.7	
	F	6	169	7.2	1.95	4.2	5.0	6.0	7.1	8.2	9.6	10.8
		7	172	8.4	2.10	5.0	5.7	7.0	8.3	9.6	11.1	13.5
		8	157	10.0	2.60	5.5	6.8	8.3	9.9	11.2	13.6	14.6
		9	159	12.3	3.00	6.9	8.5	10.3	11.9	14.0	16.0	18.9
		10	142	14.6	3.61	8.7	10.5	12.0	14.3	16.7	19.5	22.5
11		151	17.5	3.89	10.7	12.6	15.2	17.2	20.0	22.3	25.3	
12		185	18.2	4.52	9.7	12.9	15.0	18.3	21.5	24.1	27.2	
13		155	20.1	4.31	13.9	15.2	17.2	19.7	22.1	25.0	30.4	
14		151	21.4	4.13	14.4	15.8	18.2	21.5	24.1	26.9	29.5	
15		151	22.1	4.18	14.8	17.0	19.3	21.8	25.1	28.1	30.5	
16		158	22.1	4.24	13.5	16.8	19.3	22.0	24.7	27.4	30.0	
17		200	22.9	4.13	15.1	18.0	19.8	22.5	25.8	28.1	32.1	
18		156	23.6	4.48	16.1	18.1	20.8	23.2	26.2	29.6	33.7	
19		117	23.1	4.89	15.0	17.3	19.4	22.5	26.1	29.5	34.4	
20		97	24.3	4.82	15.8	18.6	21.0	23.9	27.8	30.6	34.1	
21		63	24.2	4.84	14.9	17.8	20.1	23.6	28.1	30.1	34.6	
22		32	23.2	5.13	11.3	14.9	20.3	24.4	26.9	28.0	31.2	

Table 3-2-5-6 Back strength (kg)

Gender	Age group (years)	n	Mean	SD	P ₃	P ₁₀	P ₂₅	P ₅₀	P ₇₅	P ₉₀	P ₉₇	
M	6	238	25.5	8.69	12.2	15.0	19.0	25.0	31.0	37.0	46.0	
	7	237	29.6	8.78	17.0	19.0	24.0	28.0	35.0	41.0	49.9	
	8	257	33.8	9.26	20.0	23.0	27.0	33.0	39.5	46.0	53.0	
	9	187	40.2	11.76	22.0	26.0	32.0	38.0	48.0	56.0	64.4	
	10	199	45.1	12.84	25.0	31.0	37.0	43.0	52.0	63.0	72.0	
	11	180	54.6	16.02	27.0	35.0	43.0	53.0	65.0	75.0	90.7	
	12	208	62.9	18.05	31.0	41.0	50.0	62.0	74.0	86.1	102.5	
	13	200	75.5	22.03	34.0	48.1	59.5	77.0	86.8	103.9	118.0	
	14	186	82.5	24.65	39.6	52.0	65.0	82.0	96.0	111.9	143.0	
	15	169	91.9	25.90	43.4	59.0	76.5	91.0	107.0	120.0	148.8	
	16	174	97.2	27.14	49.3	60.5	76.8	97.0	116.3	129.5	149.0	
	17	184	100.2	29.59	44.3	61.0	82.0	101.0	119.5	134.5	161.0	
	18	162	107.2	27.08	65.8	74.0	87.0	105.5	124.3	144.4	166.0	
	19	127	105.2	25.54	57.2	70.6	88.0	103.0	124.0	139.0	152.0	
	20	105	107.2	25.57	62.2	74.8	91.5	105.0	126.5	139.6	156.1	
	21	58	107.1	24.92	65.1	79.8	90.0	101.5	122.0	139.9	177.3	
	22	41	107.1	19.44	66.1	75.0	93.0	110.0	120.0	125.6	148.4	
	F	6	171	23.2	8.85	13.0	15.0	18.0	22.0	26.0	32.0	37.8
		7	172	25.1	6.96	14.2	17.0	20.0	24.0	29.0	33.7	41.8
		8	157	28.2	7.46	16.7	19.0	23.5	27.0	32.0	38.2	45.3
		9	159	33.1	9.95	16.8	22.0	26.0	32.0	38.0	49.0	55.0
		10	142	37.1	11.00	17.6	24.0	29.0	37.0	43.0	52.4	63.7
11		151	45.2	14.36	19.6	26.2	36.0	45.0	55.0	63.0	72.9	
12		185	46.4	15.37	19.0	26.0	34.0	47.0	58.0	68.4	74.0	
13		155	51.2	15.63	19.4	31.0	41.0	51.0	61.0	73.4	81.6	
14		151	56.2	13.68	29.6	38.2	47.0	55.0	66.0	74.8	78.9	
15		151	57.6	15.36	26.1	38.2	47.0	57.0	69.0	79.0	84.4	
16		158	53.8	16.56	23.0	31.9	43.0	53.5	64.3	78.1	86.5	
17		199	56.5	16.64	27.0	35.0	44.0	56.0	67.0	79.0	92.0	
18		156	58.4	14.98	33.0	38.0	49.0	57.0	67.0	77.0	89.6	
19		117	53.8	15.59	18.5	29.8	45.5	55.0	65.0	71.2	80.4	
20		97	58.7	14.95	25.0	38.0	50.0	58.0	69.0	78.2	88.1	
21		63	61.7	14.24	39.8	44.0	50.0	61.0	73.0	81.6	88.9	
22		32	58.4	19.37	15.0	38.5	47.3	54.0	72.0	82.0	89.1	

Table 3-2-5-7 Endurance run (sec)

Gender	Age group (years)	n	Mean	SD	P ₃	P ₁₀	P ₂₅	P ₅₀	P ₇₅	P ₉₀	P ₉₇	
M	6	226	151.6	22.93	117.7	127.0	135.2	148.5	162.2	184.0	208.9	
	7	211	142.6	19.65	110.5	119.1	130.2	139.4	152.8	169.0	184.9	
	8	244	140.2	19.48	105.6	115.2	127.3	139.5	152.9	167.3	182.1	
	9	177	145.9	22.11	107.1	122.0	130.7	142.0	156.9	179.8	197.1	
	10	188	142.2	21.37	105.8	118.2	126.7	141.0	155.9	171.5	190.4	
	11	160	136.7	20.81	105.0	113.4	121.6	134.9	148.8	161.1	189.0	
	12	171	127.5	21.02	95.3	104.2	111.2	124.9	138.9	157.0	172.4	
	13	179	348.1	60.42	239.3	269.7	309.2	343.7	387.6	419.6	493.0	
	14	163	327.0	63.48	240.4	254.0	277.5	324.0	364.1	417.3	465.4	
	15	130	322.5	67.54	228.9	244.0	263.5	309.1	367.2	425.7	452.6	
	16	146	316.4	61.63	218.5	240.5	269.9	306.2	348.7	414.4	441.1	
	17	163	309.0	53.33	223.0	247.8	268.8	305.0	341.6	380.7	428.8	
	18	145	304.4	52.59	227.6	246.1	268.1	293.5	322.4	389.2	428.9	
	19	113	312.9	57.91	206.4	250.1	276.4	307.6	345.8	391.8	471.4	
	20	97	305.7	49.37	219.0	242.9	269.6	302.0	333.9	379.7	409.9	
	21	53	316.4	41.90	241.9	253.0	272.7	323.1	351.1	362.2	388.8	
	22	34	318.5	45.24	251.5	261.2	284.7	312.8	355.9	385.8	399.8	
	F	6	163	153.6	18.92	123.4	130.3	139.7	152.3	163.8	175.7	196.8
		7	161	146.7	17.89	116.5	127.4	134.7	144.2	157.1	171.0	188.6
		8	149	145.1	19.40	114.3	119.0	131.4	145.9	156.4	169.5	182.5
		9	150	146.2	16.48	114.2	126.1	135.9	146.5	156.3	169.6	181.1
		10	135	142.3	18.08	114.9	120.3	130.1	141.5	153.0	163.4	184.6
11		134	138.9	18.53	112.5	119.2	125.4	135.8	147.7	163.0	181.5	
12		167	130.0	15.88	100.8	110.4	119.6	128.1	140.4	152.0	162.4	
13		136	297.0	47.76	230.5	239.0	262.1	291.8	322.5	354.8	422.0	
14		129	287.0	42.56	221.3	235.3	253.3	283.3	313.4	343.6	364.1	
15		114	280.6	50.26	206.0	231.7	249.0	267.2	309.0	343.6	384.1	
16		121	290.4	41.07	222.0	241.0	259.8	282.7	317.3	351.9	375.6	
17		176	289.4	38.67	209.1	234.0	264.5	293.9	313.1	335.0	360.6	
18		127	296.9	44.09	226.0	245.7	265.8	293.8	325.0	360.2	377.9	
19		92	285.4	39.85	224.4	240.2	251.4	282.8	310.4	344.7	377.2	
20	75	290.9	37.63	220.7	248.0	259.5	290.6	314.5	343.8	371.6		
21	47	275.1	45.41	130.6	239.6	252.5	279.8	301.1	320.8	364.4		
22	27	297.5	46.97	205.9	236.3	266.2	296.3	342.1	351.2	366.3		

Note: 50m x 8 shuttle run for students aged 6-12; 800m run for female students aged 13-22; 1,000m run for male students aged 13-22.

Table 3-2-5-8 Sit and reach (cm)

Gender	Age group (years)	n	Mean	SD	P ₃	P ₁₀	P ₂₅	P ₅₀	P ₇₅	P ₉₀	P ₉₇	
M	6	238	4.3	5.10	-5.1	-2.2	0.7	4.2	8.4	11.2	13.6	
	7	238	3.3	6.10	-9.6	-4.8	-0.5	3.5	7.4	10.8	13.8	
	8	257	2.9	6.46	-10.3	-5.6	-0.7	3.2	7.7	11.4	14.2	
	9	188	2.4	6.60	-10.1	-7.6	-1.6	2.5	6.7	10.7	14.7	
	10	199	0.3	6.65	-13.5	-9.7	-4.1	0.6	4.8	9.1	11.8	
	11	180	1.0	7.60	-13.2	-9.8	-5.0	1.2	7.0	10.2	14.9	
	12	208	0.9	7.06	-12.8	-9.2	-3.6	1.5	5.6	10.6	14.2	
	13	200	1.5	7.22	-14.6	-7.6	-3.3	2.0	5.8	10.2	15.7	
	14	186	3.9	8.26	-11.5	-7.6	-1.9	3.8	9.2	14.4	21.4	
	15	168	3.6	9.87	-16.9	-11.0	-2.9	4.3	10.2	17.5	21.2	
	16	174	3.5	9.41	-16.0	-10.0	-2.6	3.8	9.7	15.7	21.8	
	17	184	4.2	9.60	-14.7	-8.5	-2.4	4.4	11.6	16.4	22.5	
	18	163	4.4	9.17	-14.9	-8.9	-1.1	5.0	11.3	15.8	20.1	
	19	127	2.9	9.39	-16.2	-10.3	-4.6	3.8	9.4	13.9	19.7	
	20	106	4.3	8.62	-16.2	-6.5	-0.9	5.0	10.6	15.7	18.0	
	21	57	0.6	9.55	-17.1	-13.4	-7.4	1.4	8.1	11.6	19.6	
	22	41	3.2	9.74	-18.9	-9.4	-4.9	3.3	11.3	14.9	22.0	
	F	6	171	7.6	5.72	-2.6	0.0	3.2	7.5	12.7	15.4	17.2
		7	172	7.4	6.17	-6.2	-0.8	4.5	7.8	12.3	15.3	17.4
		8	157	8.3	6.19	-5.5	0.6	5.1	8.7	12.8	16.5	18.5
		9	160	7.8	6.77	-7.7	-1.7	4.1	8.4	12.3	16.3	18.9
		10	142	6.4	7.67	-7.9	-4.4	2.4	6.5	12.3	17.0	19.9
11		151	6.4	8.09	-9.0	-3.3	1.3	6.0	11.9	17.6	22.0	
12		185	8.4	8.63	-8.3	-3.4	3.0	8.3	14.5	20.2	25.2	
13		155	9.8	9.52	-9.5	-2.9	3.1	10.0	17.4	22.3	26.8	
14		151	10.4	9.34	-8.5	-1.5	3.5	10.5	17.7	22.1	28.6	
15		152	9.2	8.95	-10.4	-1.9	3.3	10.5	15.3	20.8	25.0	
16		158	10.2	9.25	-14.0	-0.4	4.7	11.1	17.1	21.1	25.1	
17		200	9.5	10.02	-12.9	-4.6	3.5	10.6	17.0	22.1	26.2	
18		151	10.5	8.46	-6.6	-1.8	4.7	11.9	17.2	21.3	23.5	
19		116	8.1	8.87	-8.5	-5.1	0.8	9.2	14.7	20.5	22.2	
20		95	8.8	9.12	-11.1	-5.4	3.0	9.7	16.1	19.0	21.9	
21		58	8.4	8.15	-8.1	-6.1	3.8	9.7	15.2	18.0	20.1	
22		28	5.3	8.15	-8.7	-6.2	-1.8	5.3	12.7	16.0	21.2	

Table 3-2-5-9 Choice reaction time (sec)

Gender	Age group (years)	n	Mean	SD	P ₃	P ₁₀	P ₂₅	P ₅₀	P ₇₅	P ₉₀	P ₉₇	
M	6	233	0.60	0.08	0.46	0.50	0.54	0.59	0.64	0.70	0.77	
	7	237	0.57	0.07	0.45	0.48	0.52	0.56	0.61	0.66	0.73	
	8	257	0.54	0.07	0.42	0.45	0.48	0.54	0.59	0.62	0.65	
	9	188	0.51	0.07	0.40	0.43	0.46	0.49	0.55	0.60	0.63	
	10	199	0.47	0.06	0.38	0.41	0.43	0.46	0.50	0.56	0.61	
	11	180	0.45	0.05	0.36	0.39	0.41	0.44	0.48	0.52	0.56	
	12	208	0.43	0.05	0.35	0.37	0.40	0.43	0.46	0.49	0.54	
	13	200	0.43	0.05	0.34	0.36	0.38	0.43	0.46	0.49	0.54	
	14	186	0.41	0.05	0.33	0.35	0.37	0.41	0.45	0.49	0.53	
	15	169	0.41	0.05	0.33	0.35	0.37	0.40	0.44	0.47	0.51	
	16	174	0.40	0.05	0.32	0.34	0.37	0.40	0.43	0.47	0.50	
	17	184	0.39	0.05	0.31	0.33	0.36	0.39	0.41	0.45	0.47	
	18	163	0.38	0.04	0.31	0.33	0.36	0.38	0.40	0.43	0.46	
	19	127	0.37	0.04	0.29	0.33	0.35	0.37	0.40	0.42	0.47	
	20	106	0.37	0.03	0.31	0.33	0.35	0.38	0.39	0.41	0.44	
	21	58	0.38	0.04	0.30	0.33	0.35	0.37	0.41	0.43	0.46	
	22	41	0.39	0.04	0.33	0.33	0.35	0.38	0.40	0.44	0.50	
	F	6	168	0.61	0.08	0.47	0.51	0.56	0.60	0.66	0.70	0.77
		7	172	0.58	0.07	0.46	0.50	0.53	0.58	0.62	0.68	0.74
		8	156	0.55	0.06	0.43	0.46	0.51	0.55	0.59	0.63	0.67
		9	160	0.53	0.07	0.43	0.45	0.48	0.51	0.58	0.63	0.66
		10	141	0.49	0.06	0.38	0.42	0.45	0.48	0.52	0.57	0.62
11		151	0.47	0.06	0.37	0.40	0.43	0.46	0.51	0.54	0.60	
12		185	0.46	0.05	0.37	0.40	0.42	0.45	0.48	0.53	0.58	
13		155	0.45	0.05	0.36	0.38	0.41	0.44	0.48	0.51	0.56	
14		151	0.44	0.06	0.35	0.37	0.40	0.44	0.48	0.51	0.54	
15		152	0.43	0.06	0.35	0.37	0.39	0.43	0.47	0.51	0.56	
16		158	0.43	0.06	0.33	0.36	0.39	0.43	0.47	0.50	0.55	
17		200	0.43	0.05	0.33	0.36	0.38	0.43	0.46	0.50	0.51	
18		156	0.41	0.04	0.33	0.36	0.38	0.41	0.43	0.46	0.51	
19		117	0.40	0.04	0.33	0.35	0.38	0.41	0.43	0.45	0.48	
20		97	0.40	0.04	0.33	0.35	0.38	0.40	0.42	0.44	0.48	
21		63	0.41	0.05	0.34	0.36	0.38	0.40	0.43	0.47	0.55	
22		32	0.41	0.05	0.30	0.35	0.38	0.40	0.43	0.47	0.53	

Table 3-2-5-10 One foot stands with eyes closed (sec)

Gender	Age group (years)	n	Mean	SD	P ₃	P ₁₀	P ₂₅	P ₅₀	P ₇₅	P ₉₀	P ₉₇	
M	6	238	13.8	9.11	4.0	6.0	9.0	11.0	17.0	23.0	31.0	
	7	238	15.9	13.24	4.0	5.9	9.0	13.0	19.0	28.0	43.8	
	8	255	19.7	16.41	4.0	6.6	10.0	15.0	24.0	37.4	71.0	
	9	188	23.2	21.77	5.0	7.0	11.0	16.0	28.0	47.1	76.9	
	10	196	25.7	22.87	5.0	7.7	11.0	18.5	31.0	50.3	90.9	
	11	177	26.0	18.14	5.0	9.0	13.0	20.0	35.0	50.4	74.0	
	12	206	32.7	30.84	4.2	8.0	13.8	22.0	40.0	77.2	119.8	
	13	200	33.2	30.97	5.0	9.0	15.0	23.0	37.8	72.6	111.9	
	14	186	32.0	30.49	3.0	7.0	12.0	23.0	39.3	67.3	121.6	
	15	169	33.1	30.97	4.0	7.0	14.0	25.0	42.5	65.0	103.0	
	16	174	40.7	39.85	5.0	8.0	15.0	26.5	56.3	88.5	149.0	
	17	184	44.4	46.18	5.6	7.0	13.0	26.5	60.8	113.0	174.5	
	18	163	40.6	39.84	3.0	6.4	14.0	26.0	55.0	83.2	149.8	
	19	127	40.3	34.98	3.0	7.8	15.0	29.0	55.0	86.2	127.9	
	20	106	41.5	36.57	5.0	9.0	16.8	31.5	53.3	84.5	167.8	
	21	58	44.9	37.10	7.3	10.0	19.0	32.0	60.0	105.8	146.0	
	22	41	40.9	34.78	3.6	10.0	17.5	30.0	57.5	104.8	124.7	
	F	6	170	17.6	11.28	5.0	8.0	10.0	15.0	20.0	30.9	41.7
		7	172	24.4	27.21	5.0	8.0	11.0	16.0	26.0	48.0	79.4
		8	157	25.0	21.73	4.7	7.0	11.0	19.0	30.5	54.2	89.1
		9	160	30.4	27.16	5.8	9.0	14.0	20.0	38.8	66.6	97.0
		10	141	30.9	31.27	6.0	10.0	14.0	22.0	38.0	60.0	105.1
11		151	28.5	29.56	5.0	9.0	12.0	21.0	34.0	54.8	103.0	
12		185	35.5	36.84	3.6	7.0	13.0	22.0	46.5	76.4	149.6	
13		155	41.6	46.74	4.0	7.0	15.0	25.0	52.0	94.0	167.9	
14		151	44.2	43.65	5.0	9.0	16.0	26.0	62.0	98.4	166.3	
15		152	53.2	58.58	5.6	12.0	19.0	34.0	60.0	110.4	270.6	
16		158	47.3	41.85	6.8	11.0	18.0	33.0	62.0	112.4	173.7	
17		200	50.7	51.37	5.0	10.1	17.0	35.5	66.0	95.8	182.9	
18		156	42.7	38.48	5.0	10.0	18.0	32.0	57.0	89.6	137.5	
19		117	38.8	30.05	5.0	12.0	17.5	28.0	56.0	84.4	108.0	
20		97	43.3	35.54	3.9	8.8	17.0	35.0	57.5	84.0	159.4	
21		63	47.5	41.13	3.0	8.5	18.8	35.5	65.0	111.5	145.8	
22		32	55.4	52.34	2.0	4.3	12.3	37.0	102.5	135.0	145.3	

6. Teeth

Table 3-2-6-1 Prevalence of decayed primary teeth (%)

Gender	Age group (years)	Subjects (n)	Decayed primary teeth (d)	Filled primary teeth (f)	Missing primary teeth (m)	Decayed-missing-filled primary teeth (dmf)
M	6	238	61.4	33.5	1.2	69.7
	7	238	66.4	41.6	4.6	75.2
	8	257	65.8	47.5	4.3	80.5
	9	188	57.4	38.3	2.7	70.7
	10	199	49.7	26.1	1.0	59.3
	11	180	25.6	11.7	0.6	30.0
	12	208	8.7	2.4	0.0	10.1
	13	200	3.5	0.5	0.0	4.0
	14	186	1.1	0.5	0.0	1.6
	15	169	1.2	0.6	0.0	1.8
	16	174	2.9	0.0	0.0	2.9
	17	174	0.6	0.0	0.0	0.6
	18	76	0.0	1.3	0.0	1.3
F	6	171	65.2	35.0	2.3	70.8
	7	172	68.6	36.0	7.6	80.8
	8	157	62.4	47.1	4.5	77.1
	9	160	60.6	31.3	1.9	68.1
	10	142	43.0	27.5	0.0	57.0
	11	150	18.0	5.3	0.0	21.3
	12	185	5.4	2.7	0.0	7.6
	13	155	3.2	1.3	0.0	4.5
	14	151	3.3	0.0	0.0	3.3
	15	152	1.3	0.0	0.0	1.3
	16	158	0.6	0.0	0.0	0.6
	17	192	0.0	0.0	0.0	0.0
	18	55	1.8	0.0	0.0	1.8

Table 3-2-6-2 Prevalence of decayed permanent teeth (%)

Gender	Age group (years)	Subjects (n)	Decayed permanent teeth (D)	Filled permanent teeth (F)	Missing permanent teeth (M)	Decayed-missing-filled permanent teeth (DMF)
M	6	238	2.8	1.2	0.4	4.4
	7	238	8.8	3.8	0.0	12.6
	8	257	7.4	7.8	0.0	13.6
	9	188	12.8	9.6	0.0	21.8
	10	199	17.1	12.6	0.5	27.1
	11	180	18.9	19.4	1.7	34.4
	12	208	23.6	21.2	1.4	40.9
	13	200	29.0	22.5	2.0	43.5
	14	186	36.0	24.7	3.8	51.1
	15	169	34.3	32.0	5.9	54.4
	16	174	42.5	30.5	10.3	60.9
	17	174	40.2	33.3	9.8	62.6
	18	76	34.2	35.5	9.2	56.6
F	6	171	9.0	0.0	0.0	9.0
	7	172	15.7	3.5	0.0	18.0
	8	157	16.6	7.0	0.0	22.3
	9	160	16.3	13.8	0.0	25.0
	10	142	28.9	11.3	1.4	37.3
	11	150	26.7	21.3	1.3	41.3
	12	185	38.9	25.4	2.2	54.1
	13	155	49.0	40.6	6.5	67.7
	14	151	41.1	49.7	9.9	70.9
	15	152	40.1	48.7	9.9	71.1
	16	158	44.9	39.9	12.7	72.2
	17	192	46.4	42.2	21.9	77.1
	18	55	43.6	52.7	9.1	78.2

7. Vision

Table 3-2-7-1 Percentage of students with various degrees of poor vision (%)

Gender	Age group (years)	Subjects (n)	Poor vision	Mild poor vision	Moderate poor vision	Severe poor vision	Near-sightedness	
M	6	238	43.7	18.5	17.6	7.6	42.0	
	7	238	45.4	9.7	18.5	17.2	44.5	
	8	257	52.1	7.4	16.3	28.4	50.2	
	9	188	60.1	6.9	22.3	30.9	58.5	
	10	199	60.8	5.5	15.6	39.7	59.8	
	11	180	66.1	5.6	16.7	43.9	63.9	
	12	208	77.4	4.8	20.2	52.4	76.0	
	13	200	74.0	8.0	12.5	53.5	71.5	
	14	186	77.4	3.2	11.3	62.9	76.9	
	15	169	81.7	4.7	13.0	63.9	81.1	
	16	174	82.2	5.2	14.9	62.1	79.9	
	17	184	82.6	3.8	10.9	67.9	82.1	
	18	163	79.1	3.1	16.0	60.1	77.3	
	19	127	80.3	3.9	15.7	60.6	79.5	
	20	106	79.2	1.9	12.3	65.1	78.3	
	21	58	81.0	8.6	15.5	56.9	72.4	
	22	41	80.5	17.1	12.2	51.2	61.0	
	F	6	171	48.5	22.2	19.3	7.0	48.0
		7	172	49.4	15.7	18.6	15.1	47.1
		8	157	55.4	12.1	19.7	23.6	53.5
		9	160	72.5	15.6	21.9	35.0	71.3
		10	142	71.8	7.0	19.7	45.1	70.4
11		151	72.7	6.6	13.9	51.7	70.2	
12		185	73.5	4.3	15.1	54.1	72.4	
13		155	73.5	2.6	19.4	51.6	71.6	
14		151	82.1	4.0	13.2	64.9	80.8	
15		152	80.9	3.9	9.2	67.8	80.9	
16		158	88.0	3.8	14.6	69.6	87.3	
17		200	89.5	2.5	12.0	75.0	87.0	
18		156	85.9	4.5	14.7	66.7	85.3	
19		117	80.3	4.3	7.7	68.4	79.5	
20		97	82.5	5.2	9.3	68.0	81.4	
21		63	84.4	4.8	9.5	69.8	84.4	
22		32	84.4	3.1	12.5	68.8	84.4	

Table 3-2-7-2 Color vision (%)

Age group (years)	M		F	
	Subjects (n)	Color vision deficiency	Subjects (n)	Color vision deficiency
6	237	4.2	171	5.8
7	238	5.5	172	3.5
8	257	4.3	157	1.3
9	188	2.1	160	2.5
10	199	2.5	142	0.0
11	180	2.2	150	0.7
12	208	6.3	185	0.0
13	200	5.5	155	0.6
14	186	3.8	151	1.3
15	168	4.8	152	0.0
16	174	2.9	157	0.6
17	184	4.3	200	0.5
18	163	3.7	155	0.6
19	127	2.4	117	0.9
20	105	4.8	96	1.0
21	58	3.4	63	1.6
22	41	2.4	32	0.0

III. Adults

1. Basic Information of the Subjects

Table 3-3-1-1 Distribution of sampling sites (organizations)

Sampling sites	Name	M		F		Subtotal	
		Subjects (n)	Percentage (%)	Subjects (n)	Percentage (%)	Subjects (n)	Percentage (%)
Government agencies	Health Bureau	32	2.1	69	2.9	101	2.6
	Education and Youth Affairs Bureau	31	2.1	55	2.3	86	2.2
	Macao Government Tourism Office	19	1.3	36	1.5	55	1.4
	Statistics and Census Service	20	1.3	36	1.5	56	1.4
	Macao Sports Bureau	53	3.5	24	1.0	77	2.0
	Municipal Affairs Bureau Civic and Municipal Affairs Bureau	110	7.3	83	3.5	193	5.0
	Marine and Water Bureau	22	1.5	11	0.5	33	0.9
	Social Welfare Bureau	26	1.7	65	2.7	91	2.3
	Land, Public Works and Transport Bureau	30	2.0	71	3.0	101	2.6
	Labour Affairs Bureau	31	2.1	37	1.6	68	1.8
	Transport Bureau	44	2.9	44	1.8	88	2.3
	Subtotal	418	27.8	531	22.2	949	24.4
	Private agencies / organizations	CEM-Companhia de Electricidade de Macau	5	0.3	4	0.2	9
Macao Polytechnic Institute		16	1.1	13	0.5	29	0.8
The Women's General Association of Macau		8	0.5	131	5.5	139	3.6
Macao New Chinese Youth Association		11	0.7	17	0.7	28	0.7
Galaxy Entertainment Group		45	3.0	55	2.3	100	2.6
Others (individual)		573	38.2	925	38.7	1498	38.5
Venetian Macau, S.A./ Sands China Ltd.		68	4.5	191	8.0	259	6.7
Christian Sheun Tao Church Hong Kong & Macau District Union Association		24	1.6	30	1.3	54	1.4
União Geral das Associações dos Moradores de Macau		15	1.0	17	0.7	32	0.8
Macao Federation of Trade Unions		61	4.1	147	6.2	208	5.3
Melco Resort and Entertainment Limited (Macao)		37	2.5	53	2.2	90	2.3
Bank of China Macau Branch		27	1.8	45	1.9	72	1.9
Macao Red Cross		3	0.2	5	0.2	8	0.2
University of Macau		17	1.1	39	1.6	56	1.4
Sheraton Grand Macao		35	2.3	58	2.4	93	2.4
SJM Holdings Limited		40	2.7	35	1.5	75	1.9
Macao Institute for Tourism		15	1.0	8	0.3	23	0.6
Macao University of Science and Technology		11	0.7	8	0.3	19	0.5
Wynn Resorts (Macao), S.A.		41	2.7	14	0.6	55	1.4
Macao Fisherman's Wharf International Investment Limited		31	2.1	65	2.7	96	2.5
Subtotal	1083	72.2	1860	77.8	2943	75.6	
Total	1501	100.00	2391	100.00	3892	100.00	

Table 3-3-1-2 Distribution of occupations in adults

Occupation	M		F		Subtotal	
	Subjects (n)	Percentage (%)	Subjects (n)	Percentage (%)	Subjects (n)	Percentage (%)
Legislative officers, public administration officers, community leaders or managers	39	2.6	50	2.1	89	2.3
Professionals	240	16.0	340	14.2	580	14.9
Technicians or professional assistants	236	15.7	293	12.3	529	13.6
Office clerks	325	21.7	880	36.8	1205	31.0
Customer service, sales representatives or similar nature	302	20.1	343	14.4	645	16.6
killed agricultural and fishery workers	3	0.2	4	0.2	7	0.2
Craftspersons or artisans	24	1.6	12	0.5	36	0.9
Machine operators, drivers or assemblers	53	3.5	5	0.2	58	1.5
Non-technicians	22	1.5	39	1.6	61	1.6
Others	184	12.3	185	7.7	369	9.5
Unemployed	67	4.5	74	3.1	141	3.6
House chores	6	0.4	166	6.9	172	4.4
Total	1501	100.0	2391	100.0	3892	100.0

Table 3-3-1-3 Residential distribution of labor intensive and non-labor intensive workers (%)

Parish	Sedentary work		Work done seated with upper limb movements		Heavy physical work		Subtotal	
	Subjects (n)	Percentage (%)	Subjects (n)	Percentage (%)	Subjects (n)	Percentage (%)	Subjects (n)	Percentage (%)
Paróquia de São Francisco Xavier	80	3.6	58	3.6	3	3.0	141	3.6
Paróquia de Nossa Senhora do Carmo	493	22.4	314	19.7	16	16.2	823	21.1
Paróquia de São Lourenço	161	7.3	138	8.7	8	8.1	307	7.9
Paróquia da Sé Catedral	175	8.0	108	6.8	2	2.0	285	7.3
Paróquia de Santo António	400	18.2	304	19.1	21	21.2	725	18.6
Paróquia de São Lázaro	151	6.9	99	6.2	2	2.0	252	6.5
Paróquia de Nossa Senhora de Fátima	734	33.4	558	35.0	47	47.5	1339	34.4
Others	6	0.3	14	0.9	0	0.0	20	0.5
Total	2200	100	1593	100	99	100	3892	100

Table 3-3-1-4 Labor intensive and non-labor intensive workers (%)

Gender	Sedentary work	Work done seated with upper limb movements	Heavy physical work
M	49.8	45.5	4.7
F	60.7	38.1	1.2

Table 3-3-1-5 Birthplace of adults in each age group (%)

Gender	Birthplace	Ages 20~24	Ages 25~29	Ages 30~34	Ages 35~39	Ages 40~44	Ages 45~49	Ages 50~54	Ages 55~59	Total
M	Mainland China	12.4	8.8	17.4	18.7	30.3	44.3	30.9	26.5	23.1
	Macao	84.6	87.4	75.1	69.4	56.2	47.9	59.1	67.6	69.1
	Hong Kong	1.8	1.4	5.2	7.8	6.7	4.2	6.1	3.8	4.6
	Portugal	0.0	0.0	0.5	0.5	0.0	0.0	0.0	0.5	0.2
	Others	1.2	2.3	1.9	3.6	6.7	3.6	3.9	1.6	3.1
F	Mainland China	18.9	16.9	18.2	26.1	44.3	60.2	50.0	44.1	32.1
	Macao	77.6	78.8	75.5	66.3	47.1	33.5	40.8	49.1	61.4
	Hong Kong	0.5	2.6	3.7	4.9	6.2	4.1	4.6	3.0	3.7
	Portugal	0.0	0.0	0.2	0.3	0.0	0.4	0.0	0.0	0.1
	Others	3.1	1.7	2.4	2.4	2.4	1.9	4.6	3.8	2.6

Table 3-3-1-6 Education level of adults in each age group(%)

Gender	Education level	Ages 20~24	Ages 25~29	Ages 30~34	Ages 35~39	Ages 40~44	Ages 45~49	Ages 50~54	Ages 55~59	Total
M	Below primary school	0.0	0.0	0.0	0.0	0.6	0.6	0.6	1.1	0.3
	Primary school	0.0	0.0	0.5	0.5	1.7	4.2	10.5	10.8	3.4
	Secondary school	13.0	7.0	16.4	17.1	25.3	22.2	27.6	36.2	20.3
	Post-secondary/university	81.1	84.2	68.1	67.9	56.7	52.7	41.4	40.5	62.2
	Master	5.9	8.8	12.7	14.5	11.8	18.6	18.2	10.8	12.6
	Doctoral	0.0	0.0	2.3	0.0	3.9	1.8	1.7	0.5	1.3
F	Below primary school	0.0	0.0	0.0	0.3	0.5	0.4	3.3	3.0	0.8
	Primary school	0.5	0.2	0.2	0.0	0.5	2.3	10.4	10.6	2.6
	Secondary school	8.7	4.7	6.5	14.6	20.0	30.8	39.2	62.0	20.7
	Post-secondary/university	83.2	80.7	72.9	62.0	57.6	51.1	34.6	19.4	60.1
	Master	7.7	14.1	19.7	22.8	21.0	13.9	11.7	4.6	15.1
	Doctoral	0.0	0.2	0.6	0.3	0.5	1.5	0.8	0.4	0.5

Table 3-3-1-7 Average working days per week of adults with regular work in each age group (%)

Gender	Working days (n)	Ages 20~24	Ages 25~29	Ages 30~34	Ages 35~39	Ages 40~44	Ages 45~49	Ages 50~54	Ages 55~59	Total
M	3 days or less	3.5	1.6	1.0	1.7	1.9	1.9	2.0	0.0	1.6
	4 days	4.4	2.7	1.0	0.0	0.6	0.0	0.7	0.0	1.1
	5 days	57.9	58.0	67.2	71.2	64.8	69.5	66.7	71.8	66.0
	6 days	34.2	33.0	29.8	24.3	25.9	26.0	29.4	27.5	28.6
	7 days	0.0	4.8	1.0	2.8	6.8	2.6	1.3	0.7	2.6
F	3 days or less	3.2	1.0	1.2	1.0	0.0	2.3	2.1	1.2	1.4
	4 days	4.0	1.6	0.7	1.0	1.5	0.5	2.1	1.2	1.4
	5 days	61.1	72.3	78.5	74.7	75.6	72.7	62.4	58.5	71.6
	6 days	29.4	21.1	18.9	20.5	22.3	20.5	31.2	36.0	23.3
	7 days	2.4	3.9	0.7	2.7	0.5	4.1	2.1	3.0	2.4

Note: 3 days or less referred to 0.0~3.0 days; 4 days referred to 3.1~4 days; 5 days referred to 4.1~5 days; and so forth.

Table 3-3-1-8 Average working hours per day of adults with regular work in each age group (%)

Gender	Working hours (n)	Ages 20~24	Ages 25~29	Ages 30~34	Ages 35~39	Ages 40~44	Ages 45~49	Ages 50~54	Ages 55~59	Total
M	5 hours or less	6.1	1.6	1.0	0.6	1.2	1.3	0.0	1.4	1.5
	5~9 hours	59.6	65.4	67.2	67.8	75.3	71.4	73.2	83.8	70.4
	9~10 hours	26.3	21.8	18.7	19.2	17.3	14.9	20.3	7.7	18.2
	10 hours or more	7.9	11.2	13.1	12.4	6.2	12.3	6.5	7.0	9.9
F	5 hours or less	7.1	0.5	1.2	1.0	0.5	4.5	3.2	6.1	2.3
	5~9 hours	62.7	65.5	69.6	71.3	81.7	74.1	78.8	84.8	72.5
	9~10 hours	21.4	23.5	19.6	16.4	11.7	15.5	11.1	5.5	16.8
	10 hours or more	8.7	10.4	9.6	11.3	6.1	5.9	6.9	3.7	8.5

Note: 5 hours or less referred to less than 5 hours; 5~9 hours included 5 hours and 5.1~8.9 hours; and so forth.

2. Lifestyle

Table 3-3-2-1 Average sleep time per day (%)

Gender	Age group (years)	Subjects (n)	Less than 6 hours	6~9 hours	9 hours or more
M	20~39	790	3.5	90.0	6.5
	40~59	711	2.8	93.4	3.8
	Total	1501	3.2	91.6	5.2
F	20~39	1412	4.3	89.0	6.7
	40~59	979	7.0	88.9	4.1
	Total	2391	5.4	89.0	5.6

Table 3-3-2-2 Average sitting hours per day (%)

Gender	Age group (years)	Subjects (n)	Less than 3 hours	3~6 hours	6~9 hours	9~12 hours	12 hours or more
M	20~24	169	5.9	19.0	46.7	17.7	10.7
	25~29	215	4.2	19.5	45.6	16.3	14.4
	30~34	213	5.2	21.6	50.7	10.3	12.2
	35~39	193	8.8	22.3	44.5	14.0	10.4
	40~44	178	4.5	34.3	39.3	12.9	9.0
	45~49	167	7.8	28.1	34.2	21.5	8.4
	50~54	181	3.9	29.2	42.6	16.6	7.7
	55~59	185	8.1	35.7	36.2	17.8	2.2
	Total	1501	6.0	26.0	42.8	15.7	9.5
F	20~24	196	0.5	20.4	50.5	12.2	16.3
	25~29	425	2.6	13.2	35.3	23.1	25.9
	30~34	462	2.6	16.0	48.9	17.3	15.2
	35~39	329	5.2	22.2	41.0	19.1	12.5
	40~44	210	4.8	19.0	45.7	19.0	11.4
	45~49	266	6.8	25.9	43.2	16.5	7.5
	50~54	240	8.8	32.5	38.3	15.0	5.4
	55~59	263	14.4	43.0	31.2	6.8	4.6
	Total	2391	5.4	22.7	41.6	16.9	13.5

Note : Less than 3 hours referred to 0 to 2 hours and 50 minutes; 3~6 hours referred to 3 hours (inclusive) to 5 hours and 50 minutes; and so forth.

Table 3-3-2-3 Major transportation means of commuting (%)

Gender	Age group (years)	Subjects (n)	Walking	Bicycling	Motorcycling	Driving	By public transport, private car or motorcycle	Others
M	20~24	169	21.3	0.0	40.8	14.8	23.1	0.0
	25~29	215	18.1	0.0	42.8	20.9	18.1	0.0
	30~34	213	20.2	0.0	38.0	29.1	12.2	0.5
	35~39	193	17.6	0.5	29.5	36.8	15.5	0.0
	40~44	178	21.9	0.0	25.8	32.0	20.2	0.0
	45~49	167	23.4	1.2	34.7	28.7	12.0	0.0
	50~54	181	21.6	0.0	30.9	29.3	18.2	0.0
	55~59	185	24.9	0.5	34.6	26.5	13.5	0.0
Total	1501	21.0	0.3	34.8	27.3	16.5	0.1	
F	20~24	196	33.7	0.0	7.7	6.1	52.6	0.0
	25~29	425	28.0	0.5	14.4	8.5	48.7	0.0
	30~34	462	24.2	0.2	14.5	14.5	46.5	0.0
	35~39	329	28.3	1.2	12.2	16.4	42.0	0.0
	40~44	210	36.2	0.5	13.3	21.0	29.1	0.0
	45~49	266	35.0	1.5	9.8	19.9	33.8	0.0
	50~54	240	32.9	0.8	9.6	21.3	35.0	0.4
	55~59	263	49.1	0.0	11.0	9.5	29.7	0.8
Total	2391	32.1	0.6	12.1	14.3	40.8	0.1	

Table 3-3-2-4 Major transportation means of commuting (%)

Gender	Age group (years)	Subjects (n)	Walking	Bicycling	Motorcycling	Driving	By public transport, private car or motorcycle	Others
M	20~39	790	19.2	0.1	37.9	25.7	17.0	0.1
	40~59	711	22.9	0.4	31.5	29.1	16.0	0.0
F	20~39	1412	27.6	0.5	13.0	12.0	47.0	0.0
	40~59	979	38.5	0.7	10.8	17.7	32.0	0.3

Table 3-3-2-5 Average days per week of walking or bicycling (%)

Gender	Age group (years)	Subjects (n)	0~2 days	3~5 days	6~7 days
M	20~24	169	46.2	23.1	30.8
	25~29	215	52.6	20.0	27.4
	30~34	213	49.3	20.2	30.5
	35~39	193	45.6	25.9	28.5
	40~44	178	42.1	23.0	34.8
	45~49	167	41.3	27.0	31.7
	50~54	181	47.5	24.3	28.2
	55~59	185	40.5	24.3	35.1
	Total	1501	45.9	23.3	30.8
F	20~24	196	35.7	33.2	31.1
	25~29	425	38.1	30.4	31.5
	30~34	462	42.4	24.2	33.3
	35~39	329	38.6	29.5	31.9
	40~44	210	26.7	31.0	42.4
	45~49	266	33.1	25.2	41.7
	50~54	240	27.9	27.1	45.0
	55~59	263	19.0	22.4	58.6
	Total	2391	34.1	27.6	38.3

Table 3-3-2-6 Average accumulated daily time of walking or bicycling (%)

Gender	Age group (years)	Subjects (n)	Less than 10 consecutive minutes	10~30 minutes	30 minutes to 1 hour	1~2 hours	2 hours or more
M	20~24	169	23.1	26.6	30.2	11.2	8.9
	25~29	215	24.7	26.5	27.0	16.3	5.6
	30~34	213	25.4	29.6	27.7	13.6	3.8
	35~39	193	22.3	32.1	30.1	9.3	6.2
	40~44	178	15.7	30.9	36.5	12.4	4.5
	45~49	167	10.8	26.3	39.5	18.0	5.4
	50~54	181	25.4	26.0	31.5	11.6	5.5
	55~59	185	23.2	26.5	34.1	13.5	2.7
	Total	1501	21.7	28.1	31.7	13.2	5.3
F	20~24	196	11.2	30.1	35.7	16.3	6.6
	25~29	425	15.8	31.1	35.1	12.9	5.2
	30~34	462	16.5	26.4	37.4	13.6	6.1
	35~39	329	14.0	28.3	31.9	19.8	6.1
	40~44	210	11.0	29.0	33.8	21.4	4.8
	45~49	266	14.7	28.2	36.8	13.9	6.4
	50~54	240	14.6	22.9	33.8	22.1	6.7
	55~59	263	7.2	22.1	30.0	25.5	15.2
	Total	2391	13.7	27.4	34.6	17.4	6.9

Note: 10~30 minutes referred to 10 minutes to less than 30 minutes; and so forth.

Table 3-3-2-7 Choice of activities during leisure time (%)

Gender	Age group (years)	Subjects (n)	Using laptop/mobile/game console	Watching TV	Physical exercise	Chatting, social gathering	House chores	Listening to the radio, music	Playing with children	Reading books, newspaper
M	20~24	169	82.2	23.7	57.4	26.0	5.3	20.1	0.0	13.6
	25~29	215	85.1	32.1	53.0	20.9	4.7	15.3	2.8	14.9
	30~34	213	80.3	41.8	38.0	16.9	12.7	15.0	24.9	11.7
	35~39	193	74.6	44.6	39.9	10.4	15.0	8.8	38.3	10.4
	40~44	178	69.1	49.4	35.4	11.2	15.7	18.5	30.9	15.2
	45~49	167	56.3	62.3	34.7	15.6	12.6	16.2	20.4	18.0
	50~54	181	57.5	66.9	46.4	11.6	14.4	18.8	9.9	14.4
	55~59	185	51.4	69.2	40.5	8.6	21.1	19.5	12.4	18.4
	Total	1501	70.2	48.3	43.2	15.2	12.6	16.4	17.5	14.5
F	20~24	196	84.2	26.5	25.5	33.2	4.6	16.3	0.0	18.4
	25~29	425	80.5	39.3	25.6	32.2	5.9	18.6	5.6	12.7
	30~34	462	74.2	44.6	26.4	23.6	13.4	12.1	23.4	13.0
	35~39	329	67.5	40.7	21.3	20.7	17.0	13.1	31.3	14.9
	40~44	210	62.9	51.4	26.2	16.7	20.0	11.4	25.2	15.2
	45~49	266	54.5	58.6	30.1	15.8	34.2	20.7	10.5	17.3
	50~54	240	55.0	65.4	26.7	18.3	37.1	12.9	2.9	12.1
	55~59	263	45.2	72.6	28.1	14.8	36.1	12.2	4.6	11.8
	Total	2391	66.9	49.0	26.1	22.5	19.6	14.7	14.0	14.1

Table 3-3-2-8 Average frequency of physical exercise per week (%)

Gender	Age group (years)	Subjects (n)	7 times or more	6 times/ week	5 times/ week	4 times/ week	3 times/ week	2 times/ week	1 times/ week	Less than 1 time/ week	Less than 1 time/ month	Never
M	20~24	169	5.9	7.7	11.2	16.0	23.7	14.8	12.4	5.9	1.2	1.2
	25~29	215	2.8	5.1	8.8	11.6	20.0	22.8	12.6	10.7	3.3	2.3
	30~34	213	3.3	7.0	6.1	8.5	17.4	15.5	16.0	15.0	6.6	4.7
	35~39	193	4.7	5.7	6.7	8.8	21.2	17.6	11.4	10.9	7.8	5.2
	40~44	178	3.4	5.6	6.2	12.9	18.5	20.8	12.9	8.4	5.1	6.2
	45~49	167	5.4	9.0	12.6	9.0	15.0	18.0	9.6	8.4	3.6	9.6
	50~54	181	5.5	8.8	12.2	17.1	16.0	19.9	9.4	6.1	1.1	3.9
	55~59	185	13.5	14.1	9.7	9.7	9.7	18.9	10.3	5.4	2.7	6.0
	Total	1501	5.5	7.8	9.1	11.6	17.7	18.6	11.9	9.1	4.0	4.8
F	20~24	196	0.5	4.1	8.7	7.1	13.8	16.8	16.3	16.8	9.7	6.1
	25~29	425	1.7	4.2	6.8	8.7	13.9	18.1	13.9	19.1	8.0	5.7
	30~34	462	1.3	1.1	4.6	8.4	15.4	20.8	17.8	13.2	10.0	7.6
	35~39	329	3.7	5.2	5.5	7.0	10.9	15.5	22.2	16.4	7.0	6.7
	40~44	210	2.9	5.7	10.5	8.1	13.8	18.1	20.0	12.9	4.3	3.8
	45~49	266	5.6	4.9	9.8	7.5	19.9	17.3	14.7	8.3	4.1	7.9
	50~54	240	10.0	9.2	11.3	9.6	15.0	20.8	8.3	6.7	1.7	7.5
	55~59	263	17.5	4.9	12.9	12.2	14.5	16.4	8.8	3.0	1.5	8.4
	Total	2391	4.9	4.5	8.1	8.6	14.6	18.2	15.5	12.6	6.3	6.8

Table 3-3-2-9 Average duration of each session of physical exercise (%)

Gender	Age group (years)	Participants (n)	Less than 10 minutes	10~19 minutes	20~29 minutes	30~59 minutes	60~119 minutes	120 minutes or more
M	20~24	167	1.8	4.2	9.0	35.9	35.9	13.2
	25~29	210	0.5	3.8	7.1	43.3	37.6	7.6
	30~34	203	1.5	7.4	14.3	43.8	29.1	3.9
	35~39	183	2.7	6.6	11.5	43.7	28.4	7.1
	40~44	167	4.8	5.4	15.0	43.7	27.5	3.6
	45~49	151	4.0	6.6	12.6	38.4	31.1	7.3
	50~54	174	1.7	3.5	12.1	38.5	33.9	10.3
	55~59	174	2.9	7.5	9.2	44.3	28.7	7.5
Total	1429	2.4	5.6	11.3	41.6	31.6	7.5	
F	20~24	184	1.6	7.1	13.6	48.4	26.6	2.7
	25~29	401	2.2	6.7	14.7	46.6	27.2	2.5
	30~34	427	2.1	6.8	18.3	44.5	26.0	2.3
	35~39	307	3.6	9.1	19.2	43.7	22.5	2.0
	40~44	202	1.0	7.9	15.8	48.0	25.3	2.0
	45~49	245	2.0	8.2	11.8	42.9	32.2	2.9
	50~54	222	2.3	4.1	11.7	43.7	33.8	4.5
	55~59	241	2.1	7.9	8.3	41.5	35.3	5.0
Total	2229	2.2	7.2	14.7	44.8	28.2	2.9	

Table 3-3-2-10 Self-perception during physical exercise (%)

Gender	Age group (years)	Participants (n)	Not much change in breathing & heart rate	Slightly increased breathing, heart rate and slight sweating	Significantly increased breathing, heart rate and more sweating
M	20~24	167	0.6	44.9	54.5
	25~29	210	1.0	32.4	66.7
	30~34	203	1.5	29.6	69.0
	35~39	183	2.2	36.6	61.2
	40~44	167	6.0	33.5	60.5
	45~49	151	4.6	45.7	49.7
	50~54	174	11.5	32.8	55.8
	55~59	174	9.8	39.1	51.2
	Total	1429	4.5	36.4	59.1
F	20~24	184	2.2	54.4	43.5
	25~29	401	2.7	57.6	39.7
	30~34	427	2.8	54.8	42.4
	35~39	307	2.3	55.4	42.4
	40~44	202	2.5	50.5	47.0
	45~49	245	9.8	46.9	43.3
	50~54	222	14.4	49.1	36.5
	55~59	241	19.1	55.2	25.7
	Total	2229	6.3	53.6	40.1

Table 3-3-2-11 Frequent exercisers and non-frequent exercisers (%)

Frequency	Duration	Intensity	Subjects (n)	Percentage (%)
Never	N/A	N/A	234	6.0%
Less than 3 times	Less than 30 minutes	Low	35	0.9%
		Moderate or above	522	13.4%
	30 minutes or more	Low	50	1.3%
		Moderate or above	1303	33.5%
3 times or more	Less than 30 minutes	Low	33	0.8%
		Moderate or above	223	5.7%
	30 minutes or more	Low	87	2.2%
		Moderate or above	1405	36.1%

Note : Subjects who exercise for 3 or more times per week, each time for 30 minutes or longer with moderate exercise intensity or higher were defined as "frequent exercisers".

Table 3-3-2-12 Frequent exercisers (%)

Gender		Age group (years)								Total
		20~24	25~29	30~34	35~39	40~44	45~49	50~54	55~59	
M	Subjects (n)	169	215	213	193	178	167	181	185	1501
	Frequent exercisers (n)	93	96	78	80	70	68	85	83	653
	Percentage (%)	55.0%	44.7%	36.6%	41.5%	39.3%	40.7%	47.0%	44.9%	43.5%
F	Subjects (n)	196	425	462	329	210	266	240	263	2391
	Frequent exercisers (n)	56	128	118	83	65	96	94	112	752
	Percentage (%)	28.6%	30.1%	25.5%	25.2%	31.0%	36.1%	39.2%	42.6%	31.5%

Table 3-3-2-13 Duration of persistent physical exercising (%)

Gender	Age group (years)	Participants (n)	None	Less than 1 month	1~3 months	3~6 months	6~12 months	1 year or more
M	20~24	167	1.8	7.8	21.6	12.6	17.4	38.9
	25~29	210	4.8	7.6	14.8	13.8	21.4	37.6
	30~34	203	5.9	8.4	18.7	10.8	13.3	42.9
	35~39	183	6.6	4.9	18.6	10.4	15.8	43.7
	40~44	167	5.4	9.0	10.2	13.8	15.6	46.1
	45~49	151	6.0	7.9	11.3	6.6	14.6	53.6
	50~54	174	3.4	3.4	8.6	9.8	13.8	60.9
	55~59	174	5.7	3.4	5.7	11.5	10.9	62.6
	Total	1429	5.0	6.6	13.9	11.3	15.5	47.9
F	20~24	184	7.1	14.1	27.7	12.0	18.5	20.7
	25~29	401	8.0	10.2	22.9	16.0	19.5	23.4
	30~34	427	5.4	10.5	20.6	17.3	16.2	30.0
	35~39	307	7.2	10.7	19.2	10.7	14.0	38.1
	40~44	202	4.0	13.9	18.8	10.9	6.9	45.5
	45~49	245	8.2	8.6	9.8	6.9	11.8	54.7
	50~54	222	4.1	4.5	13.5	9.5	11.7	56.8
	55~59	241	4.6	2.5	6.6	7.1	9.5	69.7
	Total	2229	6.2	9.4	17.9	12.1	14.2	40.2

Table 3-3-2-14 Frequency (days) of strength training per week(%)

Gender	Age group (years)	Participants (n)	0 day	1 day	2 days	3 days	4 days	5 days	6 days	7 days
M	20~24	167	22.2	15.6	16.2	19.1	10.2	7.8	4.2	4.8
	25~29	210	25.7	20.0	16.2	20.5	7.1	6.7	2.4	1.4
	30~34	203	39.4	15.3	15.3	14.3	3.9	6.4	3.0	2.5
	35~39	183	36.6	14.2	10.4	17.5	8.7	7.7	2.2	2.7
	40~44	167	40.7	18.6	9.6	12.6	9.0	4.2	2.4	3.0
	45~49	151	40.4	16.6	15.2	14.6	4.0	5.3	2.6	1.3
	50~54	174	39.7	17.2	16.1	9.2	7.5	6.9	1.1	2.3
	55~59	174	46.0	16.1	11.5	9.2	5.7	4.6	2.3	4.6
	Total	1429	36.1	16.7	13.9	14.8	7.0	6.2	2.5	2.8
F	20~24	184	53.3	16.8	10.3	8.2	4.3	4.9	1.1	1.1
	25~29	401	50.6	17.2	14.5	10.2	3.7	2.5	0.7	0.5
	30~34	427	51.8	20.8	13.3	9.1	2.1	1.4	0.5	0.9
	35~39	307	59.0	15.3	10.1	7.8	2.6	1.3	2.0	2.0
	40~44	202	62.4	15.3	7.9	6.9	1.5	2.5	0.5	3.0
	45~49	245	64.1	14.3	9.0	6.9	0.8	2.4	1.2	1.2
	50~54	222	72.5	7.7	8.6	4.1	2.3	2.7	0.9	1.4
	55~59	241	74.3	8.3	6.2	3.7	1.7	0.8	0.8	4.1
	Total	2229	59.5	15.2	10.6	7.5	2.4	2.2	0.9	1.6

Table 3-3-2-15 Major physical exercises (%)

Gender	Age group (years)	Subjects (n)	Walking	Running	Swimming	Badminton	Yoga, Pilates	Bicycling	Hiking, rock climbing	Strength exercises, body building	None
M	20~24	169	47.3	78.1	46.2	40.8	4.1	28.4	13.6	46.2	0.6
	25~29	215	43.7	80.0	47.4	46.5	7.0	26.5	19.1	48.8	2.8
	30~34	213	53.5	79.3	46.9	34.3	5.6	31.5	16.0	34.7	3.3
	35~39	193	56.0	73.6	49.2	26.9	9.3	35.8	23.3	32.6	4.7
	40~44	178	64.6	76.4	44.9	40.4	7.9	41.6	27.0	26.4	4.5
	45~49	167	74.3	71.9	55.1	37.1	7.8	44.9	25.7	18.0	1.8
	50~54	181	72.4	66.9	47.5	37.0	10.5	42.5	29.3	18.2	1.7
	55~59	185	74.6	68.6	41.6	28.6	8.6	30.8	19.5	13.0	4.9
	Total	1501	60.2	74.6	47.3	36.5	7.6	34.9	21.5	30.2	3.1
F	20~24	196	63.3	61.2	41.3	42.9	44.4	28.6	16.3	21.4	5.1
	25~29	425	67.3	58.4	38.4	35.5	51.3	27.1	25.4	24.0	4.9
	30~34	462	66.0	61.9	39.6	33.8	52.8	30.1	19.9	20.8	5.6
	35~39	329	69.6	54.4	38.0	32.8	45.3	34.3	18.8	14.9	6.7
	40~44	210	71.9	55.2	37.1	29.5	40.5	32.4	20.5	11.9	4.8
	45~49	266	75.9	44.4	32.7	27.8	42.5	26.3	23.3	9.0	7.5
	50~54	240	82.5	35.0	30.4	19.6	40.4	19.6	23.8	6.7	5.8
	55~59	263	82.5	24.0	31.9	13.7	35.0	15.2	24.3	4.9	1.9
	Total	2391	71.6	50.8	36.6	30.0	45.4	27.1	21.7	15.3	5.4

Table 3-3-2-16 Major reasons for participating in physical exercises (%)

Gender	Age group (years)	Participants (n)	Random choice	Convenient to practice	Follow the trend	Follow family members, friends or colleagues	Easy to practice	Follow professional advice
M	20~24	168	41.1	31.0	1.8	21.4	2.4	2.4
	25~29	209	41.6	24.4	0.5	26.8	2.9	3.8
	30~34	206	41.3	30.6	0.0	21.8	4.9	1.5
	35~39	184	47.3	28.3	0.5	19.0	2.2	2.7
	40~44	171	37.4	30.4	1.2	20.5	4.7	5.8
	45~49	164	42.7	25.0	0.6	20.1	4.9	6.7
	50~54	178	43.8	30.9	2.2	12.9	4.5	5.6
	55~59	179	48.0	24.6	0.6	16.8	3.4	6.7
	Total	1459	42.9	28.1	0.9	20.1	3.7	4.3
F	20~24	186	36.6	32.3	1.1	22.0	3.2	4.8
	25~29	404	36.1	36.9	1.2	18.1	5.2	2.5
	30~34	436	34.6	36.7	1.6	18.6	3.9	4.6
	35~39	307	32.2	41.4	1.0	16.9	4.2	4.2
	40~44	200	40.0	30.5	0.5	16.5	6.5	6.0
	45~49	246	41.9	31.7	1.2	15.4	6.1	3.7
	50~54	226	48.7	25.2	0.0	15.9	5.8	4.4
	55~59	258	50.0	21.7	1.2	16.3	5.8	5.0
	Total	2263	39.2	33.1	1.1	17.5	5.0	4.2

Table 3-3-2-17 Major obstacles for participating in physical exercise (%)

Gender	Age group (years)	Subjects (n)	Busy work	Burden of house chores	Lack of venues nearby	Lack of venues	Lack of coaching advice	Concern of injuries	Lack of organization	Lack of interest	Others	Lack of diversity, or activities not attractive	Financial restraint	Lack of events or activities
M	20~24	169	74.6	13.6	30.8	37.9	24.3	13.0	8.3	10.1	11.8	10.7	14.8	12.4
	25~29	215	79.5	14.9	36.7	41.9	25.1	11.2	13.5	9.3	8.4	7.0	10.7	9.3
	30~34	213	81.2	32.4	29.6	34.3	24.4	16.9	10.3	10.3	6.6	5.6	8.5	4.2
	35~39	193	86.5	53.9	26.9	27.5	13.0	18.1	10.9	7.3	5.2	2.1	5.7	5.2
	40~44	178	86.0	43.3	20.8	34.8	24.7	16.3	5.1	11.2	9.0	5.1	5.1	2.8
	45~49	167	74.3	36.5	26.3	37.7	18.6	13.2	15.0	10.2	7.2	7.8	2.4	4.8
	50~54	181	68.5	28.7	21.5	37.6	17.1	21.5	19.3	3.9	14.4	7.2	3.9	6.6
	55~59	185	64.9	29.7	25.9	31.4	21.1	16.8	17.3	4.9	11.4	7.6	1.6	3.8
	Total	1501	77.1	31.5	27.6	35.4	21.1	15.9	12.5	8.4	9.1	6.5	6.7	6.1
F	20~24	196	77.6	6.6	37.2	33.7	46.9	5.6	16.3	16.8	8.2	9.7	9.7	7.1
	25~29	425	76.9	11.3	45.4	28.7	38.6	12.5	14.8	16.9	8.2	6.1	10.4	4.0
	30~34	462	76.0	34.0	38.3	23.6	30.1	13.9	13.0	15.2	7.8	8.2	6.7	1.5
	35~39	329	69.6	44.7	32.2	21.0	26.1	10.9	10.6	16.4	11.2	7.0	4.9	4.0
	40~44	210	68.1	42.9	31.9	19.5	24.3	10.5	14.3	10.0	11.9	8.1	5.2	3.8
	45~49	266	63.5	48.5	21.4	19.5	24.1	10.5	14.3	12.8	16.5	8.6	4.5	4.5
	50~54	240	62.9	37.5	18.3	18.8	27.1	16.7	10.4	10.0	14.6	6.7	4.2	2.1
	55~59	263	49.0	38.8	24.3	17.9	20.2	14.1	14.4	9.1	14.4	6.8	3.4	3.0
	Total	2391	69.1	32.5	32.7	23.0	29.9	12.2	13.4	13.9	11.1	7.5	6.4	3.5

Table 3-3-2-18 Occurrence of diseases in the past five years (%)

Gender	Subjects diagnosed with diseases	Age group (years)								Total
		20~24	25~29	30~34	35~39	40~44	45~49	50~54	55~59	
M	Subjects (n)	169	215	213	193	178	167	181	185	1501
	Prevalence (%)	21.9	29.3	38.5	32.1	36.0	46.1	55.2	53.5	38.9
F	Subjects (n)	196	425	462	329	210	266	240	263	2391
	Prevalence (%)	29.6	32.0	44.4	40.4	48.1	55.3	59.6	55.5	44.7

Table 3-3-2-19 Diseases diagnosed in the past five years (%)

Gender	Age group (years)	Subjects diagnosed with diseases	Others	Enteritis, gastritis	Pharyngitis	Rhinitis	Accidental injury	Hypertension	Anemia	Allergic dermatitis	Hyperlipemia	Discopathy	Periodontitis	Urethritis
M	20~24	37	18.9	16.2	13.5	21.6	40.5	2.7	2.7	0.0	0.0	2.7	2.7	0.0
	25~29	63	22.2	20.6	11.1	17.5	22.2	0.0	1.6	11.1	3.2	1.6	6.3	1.6
	30~34	82	20.7	26.8	9.8	13.4	18.3	7.3	2.4	8.5	4.9	2.4	4.9	2.4
	35~39	62	22.6	17.7	24.2	17.7	19.4	6.5	1.6	3.2	9.7	6.5	4.8	0.0
	40~44	64	28.1	26.6	18.8	9.4	14.1	23.4	0.0	6.3	15.6	7.8	7.8	6.3
	45~49	77	18.2	18.2	16.9	3.9	11.7	13.0	1.3	6.5	11.7	11.7	6.5	0.0
	50~54	100	13.0	14.0	14.0	13.0	14.0	22.0	0.0	7.0	21.0	10.0	4.0	0.0
	55~59	99	17.2	11.1	8.1	12.1	3.0	28.3	3.0	6.1	12.1	2.0	6.1	0.0
Total	584	19.5	18.5	14.1	12.8	15.6	14.7	1.5	6.5	11.0	5.8	5.5	1.2	
F	20~24	58	32.8	17.2	1.7	10.3	17.2	0.0	12.1	10.3	0.0	3.4	8.6	5.2
	25~29	136	18.4	34.6	16.9	14.0	10.3	0.0	11.0	8.1	0.0	0.7	5.1	11.0
	30~34	205	26.8	31.7	12.7	13.7	8.8	1.5	11.7	10.2	1.0	5.4	4.4	12.2
	35~39	133	20.3	23.3	20.3	12.8	9.0	1.5	11.3	9.8	0.8	3.0	3.8	9.8
	40~44	101	28.7	24.8	19.8	8.9	3.0	1.0	18.8	10.9	5.0	5.0	2.0	5.0
	45~49	147	33.3	19.0	11.6	7.5	4.8	5.4	19.7	10.2	4.1	10.9	4.8	6.8
	50~54	143	25.9	14.7	13.3	7.0	6.3	16.8	13.3	9.1	7.7	10.5	13.3	3.5
	55~59	146	26.0	11.6	11.0	3.4	6.2	22.6	2.7	4.1	17.1	13.7	4.8	5.5
Total	1069	26.1	22.8	14.0	9.8	7.7	6.6	12.3	9.0	4.7	6.9	5.7	7.9	

Table 3-3-2-20 Previously heard of or participated in the "Physical Fitness Study" (%)

Gender	Previously heard of or participated in the Study	Age group (years)								Total
		20~24	25~29	30~34	35~39	40~44	45~49	50~54	55~59	
M	Subjects (n)	169	215	213	193	178	167	181	185	1501
	Heard of the Study	68.0	56.3	54.0	67.4	68.5	60.5	69.1	65.4	63.3
	Previously participated in the Study	19.5	16.7	18.8	19.7	27.0	32.9	28.7	35.7	24.5
F	Subjects (n)	196	425	462	329	210	266	240	263	2391
	Heard of the Study	59.2	55.5	57.6	61.7	68.6	67.7	63.3	63.5	61.2
	Previously participated in the Study	16.3	15.3	21.6	24.6	35.7	33.5	35.0	42.2	26.6

Table 3-3-2-21 Perception of the “Physical Fitness Study” (%)

Gender	Age group (years)	Subjects (n)	Meaningless	Understand the physical fitness status of oneself	Recognize the importance of physical exercise	Improve knowledge of scientific fitness
M	20~24	169	4.1	98.8	83.4	80.5
	25~29	215	2.3	99.1	85.6	82.3
	30~34	213	2.8	98.1	81.2	78.4
	35~39	193	3.6	96.4	81.2	75.6
	40~44	178	2.8	97.8	80.3	72.5
	45~49	167	2.4	96.4	82.6	67.7
	50~54	181	1.7	91.7	76.2	67.4
	55~59	185	1.6	96.2	73.5	57.3
	Total	1501	2.7	96.9	80.6	73.0
F	20~24	196	1.0	100.0	86.2	79.6
	25~29	425	1.6	99.8	84.7	75.5
	30~34	462	1.3	99.1	86.8	78.6
	35~39	329	1.2	99.1	84.8	76.3
	40~44	210	2.9	98.1	80.0	73.8
	45~49	266	3.4	94.7	78.2	73.7
	50~54	240	2.5	95.4	79.6	68.8
	55~59	263	4.6	89.7	72.6	68.4
	Total	2391	2.2	97.3	82.3	74.7

3. Anthropometric Measurements

Table 3-3-3-1 Height (cm)

Gender	Age group (years)	n	Mean	SD	P ₃	P ₁₀	P ₂₅	P ₅₀	P ₇₅	P ₉₀	P ₉₇
M	20~24	169	173.0	5.89	162.6	166.1	169.2	172.1	176.6	181.3	186.9
	25~29	215	173.0	5.81	162.0	166.1	169.1	172.5	176.7	181.0	186.0
	30~34	213	171.7	5.63	161.3	163.8	167.3	172.1	176.0	178.7	180.8
	35~39	193	170.4	5.71	159.9	163.2	166.0	170.2	174.4	178.0	181.2
	40~44	178	171.8	6.10	162.2	164.8	167.2	171.2	175.5	180.5	186.3
	45~49	167	169.8	5.03	160.1	163.0	166.5	170.0	173.1	177.0	179.0
	50~54	181	169.1	4.65	160.4	162.6	166.0	169.3	172.4	175.4	177.6
	55~59	185	167.6	5.06	157.3	160.7	164.1	167.7	170.5	174.7	177.5
F	20~24	196	160.4	5.62	150.3	153.2	156.6	160.1	164.1	167.3	171.4
	25~29	425	159.8	5.59	149.5	153.0	156.0	159.7	163.1	167.0	171.0
	30~34	462	159.3	5.36	149.0	152.2	155.8	159.3	162.8	166.5	168.6
	35~39	329	158.8	5.52	148.9	151.2	155.0	158.8	162.6	165.5	170.0
	40~44	210	158.5	5.59	148.4	151.5	154.9	158.4	161.9	165.5	170.0
	45~49	266	157.7	5.16	147.7	151.3	154.5	157.3	161.2	164.5	167.9
	50~54	240	156.9	5.19	147.4	150.3	153.4	156.5	160.0	164.4	166.8
	55~59	263	156.3	4.98	146.1	149.9	153.6	156.5	159.7	162.5	166.0

Table 3-3-3-2 Sitting height (cm)

Gender	Age group (years)	n	Mean	SD	P ₃	P ₁₀	P ₂₅	P ₅₀	P ₇₅	P ₉₀	P ₉₇
M	20~24	169	92.3	3.34	87.1	88.7	90.2	92.3	94.6	96.0	98.1
	25~29	215	92.4	3.16	86.3	88.4	90.2	92.3	94.6	96.4	98.6
	30~34	213	92.0	3.35	86.5	88.0	89.8	92.3	94.0	96.0	98.1
	35~39	193	91.7	3.04	86.3	88.0	89.7	91.7	93.6	95.4	97.1
	40~44	178	92.2	2.90	87.0	88.5	90.1	92.1	94.2	96.0	97.7
	45~49	167	91.3	3.91	86.2	88.2	89.8	91.5	93.5	95.2	96.6
	50~54	181	91.1	2.92	85.4	87.0	89.3	91.2	93.1	94.9	96.8
	55~59	185	90.3	2.80	83.8	87.1	88.6	90.2	92.0	93.8	95.5
F	20~24	196	86.7	3.01	80.8	83.4	84.4	86.8	88.5	90.6	92.5
	25~29	425	86.5	3.09	80.7	82.7	84.4	86.5	88.6	90.4	92.6
	30~34	462	86.3	2.87	81.0	82.8	84.4	86.2	88.3	90.0	92.0
	35~39	329	86.2	3.30	80.2	82.3	84.1	86.2	88.2	89.9	92.1
	40~44	210	86.2	3.11	80.2	82.2	84.3	86.0	88.2	90.0	92.6
	45~49	266	86.0	2.79	80.5	82.3	84.2	86.0	88.0	89.8	90.8
	50~54	240	85.3	2.80	79.6	81.8	83.6	85.1	87.0	89.0	90.6
	55~59	263	85.0	2.76	79.4	81.3	83.1	85.0	87.0	88.5	89.8

Table 3-3-3-3 Foot Length (cm)

Gender	Age group (years)	n	Mean	SD	P ₃	P ₁₀	P ₂₅	P ₅₀	P ₇₅	P ₉₀	P ₉₇
M	20~24	169	25.4	1.14	23.3	24.1	24.5	25.3	26.2	26.9	27.7
	25~29	215	25.4	1.08	23.0	24.1	24.8	25.4	26.1	27.0	27.4
	30~34	212	25.1	1.25	22.8	23.6	24.5	25.2	26.0	26.5	26.9
	35~39	193	25.1	1.07	23.1	23.9	24.4	25.1	25.7	26.5	27.2
	40~44	178	25.2	1.14	23.2	23.9	24.4	25.1	26.0	27.0	27.4
	45~49	167	25.1	0.96	23.0	23.8	24.4	25.1	25.7	26.2	27.1
	50~54	181	24.9	0.98	23.1	23.6	24.1	24.9	25.5	26.2	26.9
	55~59	185	24.6	0.97	23.0	23.4	24.0	24.6	25.1	26.0	26.7
F	20~24	196	22.8	1.00	21.0	21.6	22.1	22.9	23.6	24.2	24.6
	25~29	424	22.9	1.03	21.1	21.6	22.2	23.0	23.6	24.3	25.0
	30~34	461	22.9	1.08	20.9	21.5	22.1	23.0	23.6	24.3	25.0
	35~39	328	22.8	1.06	20.7	21.4	22.1	23.0	23.5	24.1	24.8
	40~44	210	22.8	1.04	20.9	21.5	22.1	22.8	23.4	24.1	24.9
	45~49	266	22.7	1.00	20.9	21.5	22.0	22.7	23.3	24.0	24.6
	50~54	240	22.7	0.98	20.8	21.5	22.1	22.8	23.4	24.1	24.5
	55~59	263	22.8	0.94	21.1	21.7	22.1	22.7	23.4	24.0	24.8

Table 3-3-3-4 Weight (kg)

Gender	Age group (years)	n	Mean	SD	P ₃	P ₁₀	P ₂₅	P ₅₀	P ₇₅	P ₉₀	P ₉₇
M	20~24	169	67.7	10.44	49.3	56.3	61.1	66.9	72.5	81.2	93.6
	25~29	215	70.2	10.80	52.8	58.0	63.1	68.5	75.7	84.8	98.5
	30~34	213	69.5	9.88	53.5	56.7	62.4	69.7	75.6	82.1	87.8
	35~39	193	69.5	9.88	52.9	57.5	62.5	69.1	74.9	82.0	90.2
	40~44	178	70.6	11.13	55.3	59.0	62.3	69.3	76.6	83.8	101.2
	45~49	166	68.9	10.38	52.3	57.6	61.9	67.8	74.7	80.9	94.0
	50~54	181	69.5	9.20	55.1	59.2	62.8	68.3	74.9	80.6	92.7
	55~59	185	67.4	9.09	51.9	57.1	61.8	65.5	72.2	80.8	89.4
F	20~24	196	53.3	9.08	41.0	43.8	47.3	51.7	56.4	64.2	77.3
	25~29	425	54.6	10.02	41.3	44.4	47.9	52.4	59.1	67.0	81.6
	30~34	462	54.3	8.75	41.8	45.0	48.1	53.0	58.3	65.1	75.2
	35~39	329	54.7	8.39	41.8	45.5	49.0	53.5	58.9	65.2	74.9
	40~44	210	55.9	8.27	42.7	45.9	49.5	54.8	61.2	67.4	74.5
	45~49	266	55.3	7.61	44.3	47.3	50.4	53.7	58.5	65.5	73.2
	50~54	240	56.4	8.32	42.9	47.6	50.7	55.4	60.4	67.9	76.0
	55~59	263	56.0	8.10	41.1	45.7	50.1	56.0	61.2	65.5	73.1

Table 3-3-3-5 BMI

Gender	Age group (years)	n	Mean	SD	P ₃	P ₁₀	P ₂₅	P ₅₀	P ₇₅	P ₉₀	P ₉₇
M	20~24	169	22.6	3.05	16.8	19.3	20.6	22.3	24.6	26.4	28.3
	25~29	215	23.4	3.37	18.0	19.6	21.3	22.9	24.8	28.1	32.2
	30~34	213	23.6	3.21	18.6	19.9	21.4	23.1	25.4	27.8	31.8
	35~39	193	23.9	3.18	18.7	20.2	21.6	23.7	26.0	27.9	31.2
	40~44	178	23.9	3.44	18.7	20.2	21.8	23.2	25.9	28.5	31.8
	45~49	166	24.0	3.69	18.0	20.6	22.1	23.5	25.5	28.0	33.6
	50~54	181	24.3	3.03	19.9	20.8	22.0	23.9	25.8	28.0	31.7
	55~59	185	24.0	2.96	19.6	20.9	22.1	23.4	25.4	27.6	32.0
F	20~24	196	20.7	3.35	16.4	17.7	18.7	20.1	21.7	24.1	29.4
	25~29	425	21.4	3.64	16.8	17.9	19.0	20.5	22.5	26.3	31.1
	30~34	462	21.4	3.15	17.1	18.0	19.3	20.8	22.9	25.2	28.6
	35~39	329	21.7	3.22	16.9	18.2	19.7	21.2	23.0	25.8	29.6
	40~44	210	22.2	3.04	17.9	18.8	20.0	21.7	24.2	26.9	29.0
	45~49	266	22.2	2.84	18.0	19.3	20.3	21.7	23.7	26.3	29.5
	50~54	240	22.9	3.15	18.6	19.4	20.6	22.5	24.6	26.9	30.7
	55~59	263	22.9	3.11	17.4	19.1	21.0	22.8	24.5	26.6	30.0

Table 3-3-3-6 Weight Status based on BMI classification (%)

Gender	Age group (years)	Subject (n)	Underweight	Normal	Overweight	Obese
M	20~24	169	7.1	63.9	25.4	3.6
	25~29	215	4.7	58.6	27.0	9.8
	30~34	213	2.4	58.7	30.1	8.9
	35~39	193	2.6	51.8	36.3	9.3
	40~44	178	2.3	58.4	27.5	11.8
	45~49	166	4.2	55.7	30.5	9.6
	50~54	181	0.6	50.8	39.2	9.4
	55~59	185	0.0	58.4	34.1	7.6
	Total	1500	3.0	57.0	31.2	8.8
F	20~24	196	22.5	67.4	5.1	5.1
	25~29	425	17.9	65.7	9.4	7.1
	30~34	462	13.2	70.8	11.5	4.6
	35~39	329	12.2	69.6	13.7	4.6
	40~44	210	8.1	66.2	21.0	4.8
	45~49	266	4.1	73.7	17.7	4.5
	50~54	240	2.1	66.3	25.4	6.3
	55~59	263	6.8	59.7	27.8	5.7
	Total	2391	11.4	67.7	15.6	5.4

Note: Weight Status based on BMI classification: BMI<18.5 is defined as underweight, 18.5≤BMI<24 means normal weight, 24≤BMI<28 is overweight, BMI≥28 is obese.

Table 3-3-3-7 Chest circumference (cm)

Gender	Age group (years)	n	Mean	SD	P ₃	P ₁₀	P ₂₅	P ₅₀	P ₇₅	P ₉₀	P ₉₇
M	20~24	168	91.9	7.06	78.6	82.8	87.6	91.6	96.2	100.0	107.1
	25~29	215	94.0	6.69	82.3	86.1	89.5	93.4	97.8	103.5	108.3
	30~34	213	93.6	6.34	81.8	84.8	89.2	93.3	98.4	101.9	105.7
	35~39	193	94.1	6.97	80.4	86.2	89.4	93.5	98.3	103.4	108.6
	40~44	177	94.0	6.94	83.5	84.7	89.4	93.2	99.2	103.4	107.1
	45~49	166	93.6	6.87	82.0	85.9	88.5	93.5	97.2	102.1	110.5
	50~54	181	94.3	6.56	85.0	87.0	89.7	93.2	97.6	104.2	110.0
	55~59	185	93.3	6.10	81.5	85.9	89.4	93.0	97.2	101.7	106.0
F	20~24	196	83.2	6.63	75.0	76.4	78.8	82.2	85.3	92.0	100.5
	25~29	424	84.5	6.79	75.0	77.6	79.9	83.0	87.5	93.9	101.6
	30~34	462	84.4	6.66	74.7	77.3	79.9	83.4	87.5	92.6	101.9
	35~39	329	85.1	6.52	75.2	77.3	81.0	84.0	88.5	94.0	99.7
	40~44	210	86.0	6.19	76.4	78.6	81.4	85.0	90.2	95.5	99.0
	45~49	266	86.0	6.26	76.4	79.3	81.4	85.1	89.6	94.4	100.2
	50~54	240	87.9	6.66	77.3	80.0	83.6	87.1	92.0	96.8	102.4
	55~59	263	88.3	6.82	76.0	80.0	83.5	88.0	93.1	96.5	102.1

Table 3-3-3-8 Waist circumference (cm)

Gender	Age group (years)	n	Mean	SD	P ₃	P ₁₀	P ₂₅	P ₅₀	P ₇₅	P ₉₀	P ₉₇
M	20~24	169	78.0	8.41	63.5	69.2	72.5	76.6	82.4	90.4	97.2
	25~29	215	80.4	9.33	65.6	69.8	74.0	79.0	85.0	93.5	102.6
	30~34	213	82.3	9.41	67.2	70.4	75.6	81.2	87.5	95.6	102.4
	35~39	193	83.3	8.80	68.9	72.6	76.7	83.0	88.6	93.9	102.0
	40~44	178	84.2	9.58	69.1	72.8	78.3	82.9	89.3	97.0	105.8
	45~49	166	84.7	9.18	68.4	74.4	79.0	83.7	90.3	95.1	105.3
	50~54	181	85.6	8.60	71.0	75.4	79.9	84.4	90.5	96.8	106.7
	55~59	185	84.5	7.76	71.7	76.0	79.9	83.0	88.1	94.8	104.4
F	20~24	196	70.5	8.48	59.5	62.3	65.1	69.0	73.2	80.0	92.5
	25~29	425	72.7	8.71	60.9	63.5	66.7	70.7	77.2	85.4	93.5
	30~34	462	73.6	8.38	61.9	64.4	67.9	72.2	77.5	84.4	93.6
	35~39	329	75.3	8.73	62.8	65.7	69.1	74.0	79.5	87.2	97.4
	40~44	210	77.3	8.67	63.3	67.5	72.0	75.9	82.5	89.5	97.7
	45~49	266	77.0	7.58	64.6	68.5	72.3	75.8	80.7	87.6	94.6
	50~54	240	79.8	9.03	65.6	69.1	73.4	78.6	85.0	91.5	98.9
	55~59	263	81.0	8.59	64.3	70.5	75.1	80.5	87.2	91.9	98.5

Table 3-3-3-9 Hip circumference (cm)

Gender	Age group (years)	n	Mean	SD	P ₃	P ₁₀	P ₂₅	P ₅₀	P ₇₅	P ₉₀	P ₉₇
M	20~24	168	93.7	6.58	80.9	85.8	90.1	92.8	97.0	102.1	106.8
	25~29	215	95.1	6.56	84.5	88.0	90.7	94.0	98.0	103.7	110.5
	30~34	213	95.0	6.49	84.9	87.2	90.6	94.3	98.6	104.3	109.1
	35~39	193	95.4	5.82	84.7	88.8	91.5	94.8	98.8	103.4	107.5
	40~44	178	95.6	6.69	85.1	88.1	91.0	95.2	99.8	103.5	110.2
	45~49	166	95.0	6.38	83.1	88.0	91.1	94.7	99.0	101.7	108.6
	50~54	181	95.2	5.97	85.4	88.3	91.2	95.0	98.7	102.1	107.0
	55~59	185	93.5	5.39	84.7	87.0	89.9	92.4	97.0	101.1	104.6
F	20~24	196	92.5	7.15	81.5	84.8	88.1	91.5	95.5	101.0	110.5
	25~29	425	93.6	7.36	82.8	85.7	88.6	92.5	97.1	103.0	112.2
	30~34	462	93.5	6.60	82.6	86.0	89.0	93.2	97.3	101.7	108.1
	35~39	328	93.5	6.17	83.6	86.7	89.4	92.7	96.4	101.6	108.0
	40~44	210	94.7	5.91	84.2	87.8	90.6	94.5	98.7	101.8	106.5
	45~49	266	94.0	5.70	85.3	87.7	90.2	93.3	96.6	101.9	107.4
	50~54	240	94.4	6.17	84.4	87.2	89.9	94.1	97.8	102.0	107.9
	55~59	263	93.9	5.82	83.5	86.5	89.5	93.9	97.0	100.6	106.5

Table 3-3-3-10 Waist to Hip Ratio (WHR)

Gender	Age group (years)	n	Mean	SD	P ₃	P ₁₀	P ₂₅	P ₅₀	P ₇₅	P ₉₀	P ₉₇
M	20~24	168	0.835	0.068	0.750	0.767	0.792	0.827	0.864	0.904	0.962
	25~29	215	0.844	0.055	0.754	0.779	0.807	0.834	0.875	0.922	0.956
	30~34	213	0.866	0.058	0.771	0.795	0.822	0.859	0.905	0.950	0.979
	35~39	193	0.872	0.058	0.764	0.800	0.831	0.871	0.909	0.937	0.994
	40~44	178	0.879	0.063	0.766	0.797	0.835	0.876	0.922	0.962	1.013
	45~49	166	0.892	0.081	0.772	0.812	0.841	0.890	0.936	0.972	1.013
	50~54	181	0.893	0.084	0.803	0.828	0.856	0.893	0.935	0.973	1.016
	55~59	185	0.904	0.051	0.814	0.837	0.872	0.899	0.934	0.974	1.010
F	20~24	196	0.761	0.051	0.672	0.700	0.728	0.756	0.790	0.827	0.876
	25~29	425	0.777	0.064	0.691	0.712	0.737	0.769	0.808	0.852	0.898
	30~34	462	0.786	0.057	0.701	0.722	0.743	0.779	0.818	0.863	0.910
	35~39	328	0.804	0.075	0.704	0.731	0.764	0.798	0.847	0.885	0.931
	40~44	210	0.815	0.060	0.713	0.746	0.776	0.807	0.854	0.902	0.953
	45~49	266	0.819	0.055	0.720	0.753	0.784	0.816	0.852	0.886	0.928
	50~54	240	0.845	0.064	0.742	0.770	0.803	0.834	0.888	0.929	0.995
	55~59	263	0.862	0.063	0.735	0.778	0.822	0.863	0.910	0.939	0.978

Table 3-3-3-11 Shoulder width (cm)

Gender	Age group (years)	n	Mean	SD	P ₃	P ₁₀	P ₂₅	P ₅₀	P ₇₅	P ₉₀	P ₉₇
M	20~24	169	39.4	2.04	35.5	36.7	38.0	39.5	40.8	42.0	43.3
	25~29	215	40.1	1.92	36.2	37.6	39.0	40.2	41.2	42.4	43.7
	30~34	213	39.7	1.91	35.9	37.5	38.4	39.7	41.0	42.0	43.1
	35~39	193	39.4	1.74	36.4	37.1	38.4	39.5	40.5	41.5	42.5
	40~44	178	39.7	1.93	36.2	37.4	38.4	39.6	41.0	42.0	43.8
	45~49	167	39.5	1.71	35.8	37.2	38.4	39.6	40.6	41.4	42.6
	50~54	181	39.3	1.82	35.2	36.8	38.2	39.4	40.7	41.3	42.1
	55~59	185	38.9	1.71	35.8	37.1	37.9	39.0	39.9	41.0	42.0
F	20~24	196	35.1	2.02	31.1	32.8	34.0	35.1	36.4	37.4	38.0
	25~29	424	35.3	1.79	32.3	33.2	34.2	35.4	36.4	37.5	38.4
	30~34	461	35.1	1.79	32.0	33.3	34.0	35.0	36.2	37.2	38.3
	35~39	329	35.2	1.99	31.7	33.0	34.0	35.3	36.4	37.5	38.5
	40~44	210	35.5	1.59	32.3	33.7	34.5	35.5	36.5	37.4	38.8
	45~49	266	35.4	1.51	32.5	33.3	34.4	35.5	36.4	37.2	38.1
	50~54	240	35.1	1.71	32.3	33.2	34.1	35.0	36.2	37.4	38.3
	55~59	263	35.3	1.56	32.5	33.4	34.2	35.2	36.2	37.4	38.6

Table 3-3-3-12 Pelvis width (cm)

Gender	Age group (years)	n	Mean	SD	P ₃	P ₁₀	P ₂₅	P ₅₀	P ₇₅	P ₉₀	P ₉₇
M	20~24	169	28.2	2.11	24.9	26.0	26.9	28.1	29.4	30.7	32.1
	25~29	215	28.2	1.90	25.0	26.0	27.1	28.0	29.2	30.7	32.7
	30~34	213	28.6	2.01	25.8	26.4	27.4	28.3	29.6	30.9	33.0
	35~39	193	28.7	1.79	25.8	26.5	27.4	28.6	29.8	31.2	32.3
	40~44	178	28.9	1.92	25.4	27.0	27.8	28.9	30.0	31.0	33.5
	45~49	167	28.5	1.88	25.1	26.3	27.2	28.2	29.4	30.9	33.6
	50~54	181	28.7	1.85	25.3	26.3	27.6	28.5	29.5	31.1	32.9
	55~59	184	28.7	1.72	25.9	26.8	27.5	28.3	29.7	31.2	32.3
F	20~24	196	27.2	2.36	22.9	24.7	25.7	27.0	28.3	30.2	32.4
	25~29	425	27.5	2.17	24.2	25.2	26.2	27.2	28.6	30.4	32.6
	30~34	462	27.7	2.14	24.5	25.5	26.4	27.5	28.6	30.3	33.4
	35~39	329	28.0	1.99	24.3	25.3	26.8	27.9	29.2	30.5	32.0
	40~44	210	28.3	2.18	24.6	25.6	26.7	28.0	29.5	31.3	32.6
	45~49	266	28.4	1.96	24.6	26.2	27.1	28.4	29.5	31.0	32.1
	50~54	240	28.5	2.13	24.6	26.1	27.0	28.3	29.8	31.1	33.0
	55~59	263	28.7	2.24	24.3	25.9	27.2	28.5	30.0	31.6	33.0

Table 3-3-3-13 Body fat percentage (%)

Gender	Age group (years)	n	Mean	SD	P ₃	P ₁₀	P ₂₅	P ₅₀	P ₇₅	P ₉₀	P ₉₇
M	20~24	169	19.3	5.54	10.1	11.8	15.4	18.7	23.4	26.4	31.3
	25~29	213	21.0	6.03	10.1	13.4	16.8	21.1	24.4	29.5	33.0
	30~34	213	21.6	5.52	10.7	14.2	17.4	21.8	25.1	29.3	32.1
	35~39	192	22.0	5.36	11.2	14.4	18.7	22.1	25.7	28.7	32.8
	40~44	178	22.2	5.44	12.9	15.0	18.3	22.1	25.5	29.4	32.4
	45~49	165	21.8	5.11	10.1	15.8	18.8	21.9	24.7	27.8	31.3
	50~54	181	22.8	5.13	12.6	16.8	19.1	22.9	26.3	28.7	33.9
	55~59	185	22.1	4.58	13.0	16.1	19.3	21.6	24.9	28.6	32.0
F	20~24	196	24.0	6.14	13.6	17.1	20.1	23.5	27.0	32.2	38.6
	25~29	423	25.3	6.25	14.1	17.9	21.3	25.0	29.2	33.7	38.3
	30~34	462	26.0	5.73	14.9	19.4	22.1	26.0	29.9	33.2	37.5
	35~39	328	26.8	5.62	15.7	19.7	23.3	26.5	30.2	34.2	37.8
	40~44	210	28.2	5.24	18.7	22.0	24.4	27.6	32.1	35.6	38.3
	45~49	263	28.7	4.72	20.7	23.1	25.6	28.4	31.6	34.9	38.1
	50~54	240	30.3	4.83	21.4	24.1	27.0	30.4	33.2	36.7	39.1
	55~59	262	30.4	5.05	19.5	23.2	27.2	31.1	33.7	36.3	39.0

Table 3-3-3-14 Lean body mass (kg)

Gender	Age group (years)	n	Mean	SD	P ₃	P ₁₀	P ₂₅	P ₅₀	P ₇₅	P ₉₀	P ₉₇
M	20~24	168	54.1	5.04	44.3	48.1	50.8	53.9	57.5	60.9	64.1
	25~29	213	54.9	5.07	46.5	49.0	51.2	54.3	57.8	61.9	65.3
	30~34	212	53.9	4.35	45.8	48.2	51.0	54.1	56.8	59.8	61.9
	35~39	192	53.7	4.83	45.8	47.7	50.7	53.4	56.3	58.8	63.7
	40~44	178	54.5	5.44	46.7	48.3	50.6	53.8	57.9	62.4	66.4
	45~49	165	53.5	5.15	45.5	47.3	49.9	53.0	57.0	59.4	64.2
	50~54	181	53.3	4.61	46.4	47.6	49.9	53.1	56.4	58.8	62.6
	55~59	185	52.2	4.69	44.5	46.7	49.0	51.6	55.0	58.9	62.5
F	20~24	196	40.0	3.48	34.9	35.9	37.5	39.3	41.7	44.7	48.7
	25~29	423	40.2	3.97	34.5	35.8	37.5	39.7	42.2	44.9	49.7
	30~34	462	39.8	3.52	34.6	35.9	37.3	39.4	41.6	44.1	48.1
	35~39	328	39.6	3.38	34.0	35.8	37.2	39.2	41.2	44.4	47.2
	40~44	210	39.8	3.50	33.6	35.7	37.1	39.6	41.7	44.8	47.3
	45~49	263	39.1	3.30	34.0	35.5	36.9	38.5	41.0	43.1	46.0
	50~54	240	39.0	3.49	33.0	35.2	36.6	38.5	41.0	44.2	47.4
	55~59	262	38.6	3.48	32.5	34.3	36.3	38.3	40.7	42.7	46.1

4. Physiological Function

Table 3-3-4-1 Resting pulse (bpm)

Gender	Age group (years)	n	Mean	SD	P ₃	P ₁₀	P ₂₅	P ₅₀	P ₇₅	P ₉₀	P ₉₇
M	20~24	169	72.9	10.77	54.2	60.0	65.0	71.0	82.0	88.0	93.0
	25~29	215	71.6	10.45	54.0	59.6	64.0	70.0	79.0	85.4	94.0
	30~34	212	72.2	11.25	51.4	56.3	64.3	72.0	80.0	87.0	93.0
	35~39	193	72.6	11.32	51.6	59.0	65.0	72.0	80.5	87.0	94.4
	40~44	178	69.9	10.87	50.4	55.0	62.0	70.0	77.0	83.0	92.6
	45~49	166	71.8	10.49	54.0	60.0	64.8	71.0	80.0	85.3	91.0
	50~54	181	71.5	10.41	52.0	59.2	65.0	70.0	77.0	84.8	94.6
	55~59	185	69.2	10.63	50.0	57.0	61.0	69.0	76.0	82.4	88.4
F	20~24	196	78.7	9.83	58.9	66.0	72.0	78.0	86.0	91.0	98.0
	25~29	423	77.2	9.85	59.0	64.0	71.0	77.0	84.0	90.0	95.3
	30~34	460	75.8	9.24	59.0	64.0	69.0	75.0	82.0	88.0	94.2
	35~39	327	76.0	10.42	56.0	63.0	69.0	76.0	82.0	89.0	97.2
	40~44	207	74.6	9.85	57.2	61.8	68.0	75.0	82.0	88.0	94.8
	45~49	266	74.6	9.61	58.0	63.0	67.0	75.0	81.0	88.0	92.0
	50~54	240	71.6	9.08	55.2	61.0	65.0	70.0	78.0	84.0	91.8
	55~59	262	73.0	9.18	57.0	62.0	66.8	72.0	79.0	85.0	91.0

Table 3-3-4-2 Systolic blood pressure (mmHg)

Gender	Age group (years)	n	Mean	SD	P ₃	P ₁₀	P ₂₅	P ₅₀	P ₇₅	P ₉₀	P ₉₇
M	20~24	169	126.5	11.83	102.2	109.0	119.5	128.0	134.5	140.0	145.9
	25~29	215	126.0	10.11	106.5	114.0	120.0	126.0	132.0	138.4	147.6
	30~34	213	126.6	11.59	105.4	112.0	118.5	127.0	133.0	140.0	150.6
	35~39	193	126.2	11.48	103.0	110.0	119.0	126.0	133.0	141.0	149.2
	40~44	176	127.9	12.70	103.3	111.0	120.0	128.5	136.8	144.0	151.0
	45~49	165	128.3	14.59	100.0	110.0	119.5	128.0	138.0	145.0	158.1
	50~54	180	133.2	13.14	110.0	118.1	125.0	132.0	140.0	151.8	164.1
	55~59	183	131.0	11.91	108.5	115.0	122.0	131.0	139.0	147.0	153.0
F	20~24	196	110.8	11.37	92.9	96.0	103.0	111.0	118.0	126.3	133.0
	25~29	425	111.2	10.79	91.0	98.0	104.0	111.0	119.0	126.0	132.2
	30~34	460	110.3	11.22	91.0	96.0	102.3	109.0	118.0	126.0	132.0
	35~39	329	112.5	12.48	91.9	97.0	104.0	111.0	121.0	129.0	137.2
	40~44	210	115.0	13.26	92.0	99.1	105.0	115.0	123.0	132.9	142.0
	45~49	264	118.2	14.04	94.0	101.5	108.0	117.0	127.0	137.5	150.1
	50~54	239	121.6	16.12	93.0	100.0	109.0	122.0	132.0	142.0	152.0
	55~59	263	126.4	15.80	97.8	106.0	115.0	127.0	136.0	150.0	157.0

Table 3-3-4-3 Diastolic blood pressure (mmHg)

Gender	Age group (years)	n	Mean	SD	P ₃	P ₁₀	P ₂₅	P ₅₀	P ₇₅	P ₉₀	P ₉₇
M	20~24	169	72.6	9.29	56.1	60.0	65.0	73.0	78.5	84.0	90.0
	25~29	215	72.4	8.00	57.0	62.6	67.0	72.0	77.0	83.0	88.5
	30~34	212	74.4	9.09	58.0	62.3	68.0	75.0	80.0	86.0	90.0
	35~39	193	75.6	9.34	57.6	63.0	69.0	76.0	82.0	87.6	94.0
	40~44	178	76.9	9.74	57.4	64.9	69.0	78.0	85.0	88.0	93.3
	45~49	166	76.9	10.02	57.0	64.0	70.0	77.5	84.0	89.3	98.0
	50~54	181	80.1	9.38	62.0	68.2	74.0	80.0	86.0	92.8	98.5
	55~59	184	77.7	9.22	59.6	66.0	72.0	77.0	84.0	89.5	96.9
F	20~24	196	69.1	8.70	55.0	58.7	62.0	68.0	75.0	81.3	89.1
	25~29	425	68.9	8.26	55.8	59.0	63.0	68.0	75.0	80.0	86.2
	30~34	462	68.8	8.97	53.9	58.0	62.0	68.0	74.3	81.0	87.0
	35~39	329	68.8	9.41	52.0	57.0	61.0	68.0	75.5	82.0	87.1
	40~44	210	70.1	10.47	52.0	57.0	62.0	69.5	78.0	83.9	90.7
	45~49	266	71.1	9.98	55.0	59.0	64.0	70.0	77.0	85.3	93.0
	50~54	240	72.4	10.36	52.0	59.0	65.0	72.0	80.8	87.0	91.0
	55~59	263	73.2	10.17	54.9	60.0	65.0	74.0	80.0	86.0	92.1

Table 3-3-4-4 Pressure difference (mmHg)

Gender	Age group (years)	n	Mean	SD	P ₃	P ₁₀	P ₂₅	P ₅₀	P ₇₅	P ₉₀	P ₉₇
M	20~24	169	53.9	10.16	35.0	41.0	47.0	54.0	61.0	68.0	74.7
	25~29	215	53.6	8.67	37.5	41.0	48.0	54.0	59.0	66.0	71.0
	30~34	212	52.0	9.43	34.4	41.0	46.0	52.0	58.0	64.0	70.0
	35~39	193	50.6	9.49	33.8	39.0	44.0	51.0	57.0	62.6	67.2
	40~44	176	51.2	9.13	34.3	41.0	45.0	51.5	56.8	63.3	69.7
	45~49	164	51.5	10.50	32.9	40.0	44.0	50.5	58.0	65.5	76.1
	50~54	180	53.3	8.64	38.4	43.0	48.0	52.0	58.8	64.9	74.6
	55~59	182	53.3	8.45	35.5	42.0	47.8	54.0	59.0	63.0	69.0
F	20~24	196	41.7	9.20	26.0	30.0	35.0	41.0	47.8	54.0	61.1
	25~29	425	42.4	8.27	27.8	33.0	37.0	42.0	47.0	53.4	60.0
	30~34	460	41.6	8.45	26.8	32.0	36.0	40.0	46.0	53.0	60.0
	35~39	329	43.7	8.48	28.0	33.0	38.0	43.0	49.0	55.0	61.0
	40~44	210	45.0	8.80	29.0	35.0	39.0	45.0	51.0	56.0	61.0
	45~49	264	47.2	9.96	28.0	36.0	41.0	47.0	52.0	59.5	71.0
	50~54	239	49.3	10.14	32.2	36.0	43.0	48.0	56.0	62.0	69.4
	55~59	263	53.2	11.10	33.9	39.0	45.0	53.0	61.0	66.0	75.0

Table 3-3-4-5 Vital capacity (ml)

Gender	Age group (years)	n	Mean	SD	P ₃	P ₁₀	P ₂₅	P ₅₀	P ₇₅	P ₉₀	P ₉₇
M	20~24	169	4058.1	885.17	2397.3	3000.0	3473.0	4050.0	4586.5	5130.0	5908.0
	25~29	215	4020.7	763.26	2520.3	2994.8	3556.0	4001.0	4515.0	5012.4	5449.2
	30~34	213	3865.0	837.79	2360.0	2841.0	3320.0	3811.0	4279.5	4787.2	5469.8
	35~39	193	3835.1	840.02	2355.5	2830.8	3294.0	3847.0	4292.5	4657.0	5965.9
	40~44	178	3785.2	832.48	1883.7	2789.8	3313.0	3812.0	4315.5	4822.0	5238.2
	45~49	167	3669.8	711.35	2290.0	2788.8	3175.0	3637.0	4183.0	4608.0	5057.0
	50~54	181	3544.4	599.93	2396.9	2851.2	3139.5	3545.0	3887.5	4174.4	4669.8
	55~59	184	3423.8	767.67	2056.9	2509.5	2903.8	3346.0	3844.3	4427.5	5242.6
F	20~24	196	2668.6	530.24	1833.7	2050.6	2256.8	2646.0	3006.8	3312.6	3860.9
	25~29	425	2762.1	650.87	1704.2	2100.0	2346.5	2694.0	3075.5	3436.4	4144.7
	30~34	462	2773.8	532.49	1942.1	2122.1	2395.0	2743.5	3105.8	3409.4	3920.6
	35~39	329	2692.3	594.24	1722.1	2106.0	2311.0	2628.0	3014.5	3360.0	3930.2
	40~44	210	2542.0	492.41	1504.1	2002.5	2206.5	2512.5	2902.8	3192.7	3435.1
	45~49	266	2449.4	505.57	1560.0	1859.2	2136.5	2404.5	2716.3	3089.4	3466.8
	50~54	240	2362.9	529.41	1393.0	1767.1	2025.8	2328.0	2703.8	3012.2	3427.7
	55~59	263	2225.0	562.97	1199.0	1547.4	1925.0	2174.0	2530.0	2921.6	3482.8

Table 3-3-4-6 Vital capacity/weight (ml/kg)

Gender	Age group (years)	n	Mean	SD	P ₃	P ₁₀	P ₂₅	P ₅₀	P ₇₅	P ₉₀	P ₉₇
M	20~24	169	60.7	14.38	37.7	44.4	52.0	59.6	66.6	76.8	88.9
	25~29	215	58.1	11.97	33.4	41.7	51.9	57.9	66.4	71.8	77.1
	30~34	213	56.5	13.80	33.6	38.9	48.4	55.3	64.0	73.4	90.2
	35~39	193	56.0	13.72	35.5	40.0	47.6	55.8	62.3	69.0	82.2
	40~44	178	54.3	12.38	24.8	39.2	47.7	55.3	61.9	68.9	77.7
	45~49	166	54.1	10.86	32.8	39.5	47.8	54.4	59.6	68.1	75.8
	50~54	181	51.8	10.39	30.0	40.1	45.7	51.4	57.5	64.6	70.8
	55~59	184	51.4	12.56	29.1	34.9	43.2	50.8	58.9	67.8	81.4
F	20~24	196	50.8	10.63	30.9	38.6	44.9	50.7	57.5	62.9	73.9
	25~29	425	51.5	11.92	29.9	37.7	43.9	51.2	58.2	65.2	77.9
	30~34	462	51.9	10.91	32.6	38.1	44.8	51.9	58.0	66.0	76.3
	35~39	329	49.9	11.58	28.9	37.2	42.4	49.2	56.5	64.4	73.6
	40~44	210	46.2	10.14	29.3	33.9	39.8	44.9	51.9	59.8	67.2
	45~49	266	45.0	10.28	26.5	31.7	38.9	44.7	51.4	57.8	66.8
	50~54	240	42.6	10.91	24.1	29.2	34.5	43.0	49.2	57.2	65.1
	55~59	263	40.7	12.59	19.9	25.5	33.1	39.9	46.7	55.0	68.4

Table 3-3-4-7 Step test index

Gender	Age group (years)	n	Mean	SD	P ₃	P ₁₀	P ₂₅	P ₅₀	P ₇₅	P ₉₀	P ₉₇
M	20~24	164	56.1	11.22	41.1	45.5	48.7	54.2	60.8	71.2	84.2
	25~29	212	56.5	10.84	40.5	45.2	49.5	53.9	61.5	72.4	83.8
	30~34	201	56.7	11.94	39.0	44.2	48.1	54.9	62.9	72.0	83.3
	35~39	190	58.0	13.13	42.0	46.4	49.7	55.2	63.5	71.9	88.1
	40~44	169	59.1	12.56	37.1	45.9	50.3	57.0	65.7	77.6	85.6
	45~49	151	59.4	11.88	42.6	46.9	50.6	57.3	64.8	75.6	88.8
	50~54	159	59.7	11.98	44.1	46.9	51.4	58.4	66.7	76.3	87.4
	55~59	166	61.5	11.74	41.3	47.9	52.6	61.0	68.2	76.7	88.2
F	20~24	192	56.4	11.26	42.6	45.9	49.3	53.9	60.8	72.1	80.5
	25~29	414	57.6	10.63	43.0	46.9	50.5	55.6	62.1	71.2	86.2
	30~34	454	58.5	10.10	43.1	47.2	51.7	57.5	63.8	72.6	80.2
	35~39	322	58.2	10.26	43.4	47.4	52.0	56.6	62.9	70.9	81.3
	40~44	200	60.7	12.08	43.7	49.5	53.3	58.8	66.7	74.3	89.1
	45~49	250	59.8	10.97	37.1	47.4	53.2	59.6	66.3	73.1	83.3
	50~54	220	60.8	11.66	34.7	48.4	53.9	60.0	68.1	76.3	82.9
	55~59	222	60.4	11.88	32.4	47.1	53.3	59.6	68.2	75.0	81.8

Table 3-3-4-8 VO₂max (ml O₂/kg/min)

Gender	Age group (years)	n	Mean	SD	P ₃	P ₁₀	P ₂₅	P ₅₀	P ₇₅	P ₉₀	P ₉₇
M	20~24	67	51.91	8.821	36.73	40.66	45.00	51.00	59.30	63.40	71.27
	25~29	113	48.88	9.324	34.71	38.20	43.20	47.30	53.50	61.66	72.91
	30~34	94	49.88	9.364	34.66	38.30	42.48	48.90	54.98	64.90	70.05
	35~39	91	44.18	8.876	28.88	32.00	38.20	43.90	49.50	54.38	64.34
	40~44	65	51.48	12.715	31.69	34.52	41.80	48.70	60.30	68.26	76.75
	45~49	38	48.72	12.317	23.29	31.55	39.50	49.70	56.53	65.99	73.72
	50~54	37	45.97	10.084	27.79	32.42	39.25	46.40	51.10	62.00	70.49
	55~59	43	44.01	9.148	30.73	31.92	37.20	44.50	49.60	52.18	73.28
F	20~24	66	54.06	7.192	40.21	43.21	49.08	53.90	59.23	62.78	70.66
	25~29	186	51.09	9.087	34.62	40.78	46.08	50.85	55.33	60.94	72.66
	30~34	169	51.74	8.639	35.98	42.00	46.30	51.60	56.35	62.50	71.79
	35~39	130	44.98	6.697	31.76	36.42	40.18	44.85	49.63	54.28	57.91
	40~44	69	44.26	7.979	28.96	35.70	39.30	44.10	49.50	53.00	62.31
	45~49	92	42.28	6.701	31.75	33.69	37.23	41.85	46.18	52.48	56.57
	50~54	73	36.97	6.654	25.75	30.24	32.70	35.60	40.70	45.94	54.34
	55~59	60	34.89	5.226	25.45	29.00	31.05	34.55	38.35	41.86	46.51

5. Physical Fitness

Table 3-3-5-1 Vertical jump (cm)

Gender	Age group (years)	n	Mean	SD	P ₃	P ₁₀	P ₂₅	P ₅₀	P ₇₅	P ₉₀	P ₉₇
M	20~24	169	38.6	8.51	23.8	28.3	32.4	38.2	44.2	49.6	55.7
	25~29	215	37.4	8.27	22.8	26.9	31.5	37.2	42.7	48.6	54.0
	30~34	212	35.6	7.76	22.8	26.2	30.3	35.1	40.8	44.7	54.5
	35~39	191	34.6	7.23	21.6	25.1	29.9	34.2	39.2	43.7	49.0
F	20~24	193	24.7	4.70	17.0	18.9	21.3	24.5	27.6	30.6	35.3
	25~29	411	23.7	4.34	16.5	18.3	20.6	23.6	26.0	29.8	33.1
	30~34	447	23.3	4.31	16.0	18.3	20.3	22.8	25.8	28.7	33.5
	35~39	318	23.2	4.27	15.8	18.0	20.6	22.8	25.7	28.8	32.0

Table 3-3-5-2 Push-ups (M) / One-minute sit-ups (F) (times)

Gender	Age group (years)	n	Mean	SD	P ₃	P ₁₀	P ₂₅	P ₅₀	P ₇₅	P ₉₀	P ₉₇
M	20~24	163	31.3	16.39	3.9	13.4	20.0	30.0	40.0	51.0	67.2
	25~29	213	31.7	15.85	5.8	13.4	21.0	30.0	41.0	53.6	61.2
	30~34	209	28.3	16.83	5.0	10.0	16.0	26.0	37.0	51.0	66.0
	35~39	186	26.4	13.40	5.0	10.7	16.0	25.0	35.0	46.3	53.2
F	20~24	196	26.6	8.06	10.9	16.0	22.0	26.0	31.0	36.3	44.0
	25~29	419	25.6	7.40	10.0	16.0	21.0	26.0	30.0	34.0	40.0
	30~34	453	23.6	7.52	8.0	14.0	19.0	24.0	29.0	33.0	37.0
	35~39	316	22.5	8.16	7.5	13.0	17.0	22.0	26.0	32.0	41.5

Table 3-3-5-3 Grip strength (kg)

Gender	Age group (years)	n	Mean	SD	P ₃	P ₁₀	P ₂₅	P ₅₀	P ₇₅	P ₉₀	P ₉₇
M	20~24	169	40.4	8.64	27.0	30.6	35.2	39.3	45.2	53.1	57.6
	25~29	215	41.2	7.71	25.6	32.0	36.1	40.5	46.2	50.9	56.1
	30~34	213	40.8	7.55	26.4	31.9	36.1	40.7	45.5	50.6	55.8
	35~39	193	40.1	7.62	25.7	30.0	35.7	39.6	45.1	49.8	55.5
	40~44	178	41.4	8.00	29.0	32.0	35.5	41.1	46.6	51.4	56.5
	45~49	167	40.5	7.18	28.3	31.2	35.7	39.7	45.2	49.2	57.5
	50~54	181	39.6	6.68	26.5	32.2	35.2	39.8	43.7	47.8	54.0
	55~59	185	38.6	6.67	27.0	30.3	34.2	37.8	44.1	48.0	51.2
F	20~24	196	23.8	4.29	16.4	18.8	20.7	23.7	26.2	29.3	33.0
	25~29	425	24.1	4.74	15.6	18.1	20.8	23.6	27.0	30.1	34.1
	30~34	462	23.6	4.54	15.0	18.0	20.3	23.6	26.6	29.4	32.8
	35~39	329	23.8	5.09	15.1	17.4	20.2	23.2	26.8	30.8	33.6
	40~44	210	23.8	5.20	14.2	17.3	20.0	23.9	27.2	31.3	34.5
	45~49	265	23.4	4.74	15.2	17.2	20.1	23.2	26.3	29.7	33.6
	50~54	240	22.7	4.44	13.9	17.1	19.4	22.5	25.8	28.4	31.1
	55~59	263	22.1	4.46	13.8	16.5	19.5	21.7	24.5	28.1	30.6

Table 3-3-5-4 Back strength (kg)

Gender	Age group (years)	n	Mean	SD	P ₃	P ₁₀	P ₂₅	P ₅₀	P ₇₅	P ₉₀	P ₉₇
M	20~24	167	111.2	30.62	58.0	71.6	91.0	109.0	128.0	155.2	178.8
	25~29	215	118.2	33.72	55.5	75.0	94.0	117.0	139.0	161.8	192.6
	30~34	212	110.6	32.28	47.5	71.3	91.0	111.0	128.8	148.7	181.6
	35~39	193	106.8	30.04	52.8	70.0	86.5	105.0	125.0	140.6	161.3
F	20~24	196	59.4	18.36	26.8	35.0	46.0	58.5	71.0	85.0	100.1
	25~29	425	60.4	18.43	29.8	37.0	47.0	59.0	73.0	83.0	99.0
	30~34	461	61.2	17.21	29.9	40.0	49.0	61.0	73.0	84.0	93.1
	35~39	326	58.3	18.90	27.6	35.0	44.0	57.0	70.3	85.0	97.2

Table 3-3-5-5 Sit and reach (cm)

Gender	Age group (years)	n	Mean	SD	P ₃	P ₁₀	P ₂₅	P ₅₀	P ₇₅	P ₉₀	P ₉₇
M	20~24	166	2.9	9.80	-18.1	-11.7	-3.7	3.3	9.6	15.6	19.8
	25~29	214	2.6	10.11	-16.4	-12.4	-4.4	3.4	9.4	15.1	21.5
	30~34	213	1.4	9.51	-14.6	-11.2	-6.8	2.2	8.4	13.6	20.1
	35~39	192	1.3	9.57	-15.9	-12.1	-5.4	1.0	8.0	13.3	21.3
	40~44	177	0.6	8.89	-17.9	-11.3	-5.8	0.8	7.7	11.4	15.9
	45~49	165	-0.4	9.01	-20.0	-11.2	-6.5	-0.9	6.3	10.3	18.0
	50~54	181	-0.6	8.23	-16.6	-11.9	-6.7	-0.6	5.4	10.3	13.4
	55~59	185	0.9	8.38	-14.5	-10.6	-5.4	1.5	7.1	11.6	18.0
F	20~24	196	8.9	10.13	-11.0	-4.6	1.6	9.9	16.2	22.5	25.9
	25~29	424	9.6	8.91	-9.6	-3.9	4.2	10.5	15.8	20.6	24.3
	30~34	462	7.9	9.56	-11.8	-5.2	1.6	8.3	15.2	19.0	25.3
	35~39	329	7.0	10.03	-12.9	-6.6	-0.5	7.5	14.6	19.8	23.4
	40~44	210	6.2	10.05	-13.3	-7.8	-0.6	6.7	12.9	19.0	24.9
	45~49	265	6.9	9.31	-8.9	-6.1	-0.3	7.4	13.3	19.5	24.9
	50~54	238	6.6	9.17	-10.9	-6.2	0.0	7.5	13.5	18.8	23.1
	55~59	261	7.5	9.83	-12.7	-5.8	1.5	8.5	14.9	20.1	24.8

Table 3-3-5-6 Choice reaction time (sec)

Gender	Age group (years)	n	Mean	SD	P ₃	P ₁₀	P ₂₅	P ₅₀	P ₇₅	P ₉₀	P ₉₇
M	20~24	169	0.39	0.054	0.30	0.33	0.36	0.39	0.42	0.45	0.51
	25~29	215	0.39	0.052	0.30	0.34	0.36	0.38	0.42	0.46	0.52
	30~34	213	0.41	0.052	0.32	0.35	0.38	0.40	0.44	0.47	0.52
	35~39	193	0.42	0.053	0.32	0.35	0.39	0.42	0.46	0.49	0.53
	40~44	178	0.42	0.055	0.33	0.36	0.38	0.42	0.44	0.48	0.53
	45~49	167	0.43	0.063	0.34	0.36	0.39	0.42	0.47	0.51	0.58
	50~54	181	0.45	0.058	0.37	0.39	0.41	0.44	0.48	0.53	0.59
	55~59	185	0.46	0.069	0.36	0.39	0.41	0.44	0.51	0.55	0.60
F	20~24	196	0.44	0.059	0.35	0.37	0.40	0.43	0.47	0.50	0.56
	25~29	423	0.44	0.055	0.35	0.37	0.40	0.43	0.47	0.51	0.56
	30~34	462	0.45	0.058	0.35	0.38	0.40	0.44	0.48	0.52	0.57
	35~39	329	0.45	0.051	0.36	0.38	0.41	0.44	0.48	0.51	0.55
	40~44	210	0.46	0.056	0.36	0.38	0.42	0.45	0.48	0.52	0.58
	45~49	266	0.47	0.071	0.37	0.39	0.42	0.47	0.51	0.58	0.64
	50~54	240	0.49	0.073	0.37	0.40	0.43	0.49	0.53	0.59	0.66
	55~59	263	0.50	0.080	0.38	0.41	0.44	0.49	0.55	0.61	0.69

Table 3-3-5-7 One foot stands with eyes closed (sec)

Gender	Age group (years)	n	Mean	SD	P ₃	P ₁₀	P ₂₅	P ₅₀	P ₇₅	P ₉₀	P ₉₇
M	20~24	169	44.8	45.33	4.1	7.0	13.0	29.0	66.0	97.0	149.3
	25~29	214	44.8	43.06	4.0	6.5	14.0	31.0	61.0	106.5	165.1
	30~34	213	38.7	38.19	4.0	6.0	12.0	24.0	56.0	88.2	123.7
	35~39	193	37.9	38.80	4.0	5.4	12.0	24.0	49.5	85.0	171.5
	40~44	177	27.2	28.98	3.0	4.0	7.5	17.0	37.0	63.4	100.3
	45~49	166	30.3	37.77	3.0	5.0	9.0	20.0	37.0	57.3	149.8
	50~54	181	20.2	19.92	3.0	4.2	6.0	14.0	26.0	44.6	69.1
	55~59	185	17.5	12.65	4.0	5.6	8.0	14.0	22.0	34.4	52.5
F	20~24	195	44.5	43.58	3.9	8.0	15.0	30.0	62.0	101.8	170.1
	25~29	425	43.8	43.19	4.0	6.0	13.0	29.0	58.5	105.4	150.2
	30~34	461	44.9	41.18	5.0	9.0	18.0	33.0	59.5	93.8	155.5
	35~39	329	37.1	33.57	4.0	7.0	14.0	25.0	52.0	82.0	121.6
	40~44	210	32.0	28.32	3.3	5.0	11.0	21.0	48.0	73.9	100.3
	45~49	266	27.0	30.14	4.0	6.0	10.0	18.0	34.0	58.0	90.0
	50~54	238	22.9	23.95	3.2	5.0	8.0	15.0	26.0	56.1	98.2
	55~59	262	17.8	22.47	3.0	4.3	7.0	10.5	21.0	39.0	66.3

IV. Seniors

1. Basic Information of the Subjects

Table 3-4-1-1 Distribution of sampling sites (senior agencies)

Parish/Area	Sampling site (senior agency)	M		F		Subtotal	
		Subjects (n)	Percentage (%)	Subjects (n)	Percentage (%)	Subjects (n)	Percentage (%)
Nossa Senhora de Fátima (Northern area)	Community Organizations of União Geral das Associações dos Moradores de Macau (General Union of Neighbourhood Associations of Macau)	3	0.8	45	6.3	48	4.5
	Centro de Convívio da Associação de Mútuo Auxílio dos Moradores de Mong-Há	4	1.1	10	1.4	14	1.4
	Centro de Convívio da Obra das Mães	6	1.7	34	4.7	40	3.7
	Centro de Actividades para Idosos de “Tung Sin Tong” (Macao Tung Sin Tong Charitable Society Senior Activity Center)	1	0.3	29	4.1	30	2.8
	Service Centers of Federação das Associações dos Operários de Macau (Macao Federation of Trade Unions)	6	1.7	17	2.4	23	2.1
Santo António and São Lázaro (Central area)	Centro das Idosas da Associação Geral das Mulheres de Macau	2	0.6	24	3.4	26	2.4
	Centro de Dia “Chong Pak Chi Ká”	4	1.1	23	3.2	27	2.5
Sé Catedral, São Lourenço and Nossa Senhora do Carmo (Southern & island area)	Centro de Convívio da Associação dos Habitantes das Ilhas Kuan Iek	3	0.8	23	3.2	26	2.4
	Macao Polytechnic Institute – Seniors Academy	8	2.2	49	6.8	57	5.3
	Service Centers of Associação Geral das Mulheres de Macau (The Women’s Association of Macau)	2	0.6	88	12.3	90	8.4
	Casa dos “Pinheiros” da Taipa	7	0.2	30	4.2	37	3.4
	Centro Diurno Prazer para Idosos da Associação Geral das Mulheres de Macau	118	33.0	33	4.6	151	14.1
Others	Individuals aged 60 onwards working in the sampling sites of adults subjects	194	54.2	311	43.4	505	47.0
Total		358	100.0	716	100.0	1074	100.0

Table 3-4-1-2 Residential distribution of seniors (%)

Parish	M	F	Total
São Francisco Xavier	29.3	9.6	16.2
Nossa Senhora do Carmo	17.6	22.2	20.7
São Lourenço	5.6	7.3	6.7
Sé Catedral	6.7	8.5	7.9
Santo António	18.2	20.0	19.4
São Lázaro	6.1	8.4	7.6
Nossa Senhora de Fátima	16.5	24.0	21.5

Table 3-4-1-3 Birthplace of seniors in each age group (%)

Gender	Birthplace	Ages 60~64	Ages 65~69	Ages 70~74	Ages 75~79	Total
M	Mainland China	40.2	49.4	66.3	82.4	59.2
	Macao	44.3	44.4	32.6	10.6	33.2
	Hong Kong	10.3	2.5	0.0	4.7	4.5
	Portugal	2.1	0.0	0.0	0.0	0.6
	Others	3.1	3.7	1.1	2.4	2.5
F	Mainland China	43.7	53.5	74.0	76.2	57.4
	Macao	44.0	37.3	21.9	18.8	33.9
	Hong Kong	3.2	1.8	0.7	2.0	2.1
	Portugal	0.0	0.5	0.0	0.0	0.1
	Others	9.1	6.9	3.4	3.0	6.5

Table 3-4-1-4 Education level of seniors in each age group (%)

Gender	Education level	Ages 60~64	Ages 65~69	Ages 70~74	Ages 75~79	Total
M	Below primary school	4.1	11.1	15.8	9.4	10.1
	Primary school	14.4	22.2	32.6	42.4	27.7
	Secondary school	63.9	54.3	45.3	42.4	51.7
	Post-secondary/university	13.4	11.1	5.3	5.9	8.9
	Master	4.1	1.2	0.0	0.0	1.4
	Doctoral	0.0	0.0	1.1	0.0	0.2
F	Below primary school	10.7	12.0	25.3	36.6	17.7
	Primary school	23.0	36.4	28.8	35.6	30.0
	Secondary school	54.4	39.6	36.3	24.8	42.0
	Post-secondary/ university	10.3	10.6	9.6	3.0	9.2
	Master	0.8	0.5	0.0	0.0	0.5
	Doctoral	0.8	0.9	0.0	0.0	0.6

Table 3-4-1-5 Labor intensity of daily work of seniors in each age group (%)

Gender	Labor intensity at work	Ages 60~64	Ages 65~69	Ages 70~74	Ages 75~79	Total
M	Sedentary work	44.3	45.7	45.7	62.4	52.0
	Work done seated with upper limb movements	45.4	48.1	48.1	37.6	42.7
	Heavy physical work	10.3	6.2	6.2	0.0	5.3
F	Sedentary work	42.1	46.1	26.7	62.4	45.5
	Work done seated with upper limb movements	56.3	53.0	60.3	35.6	53.2
	Heavy physical work	1.6	0.9	0.7	2.0	1.3

Table 3-4-1-6 Occupation before retirement /current occupation of seniors in each age group (%)

Gender	Occupation before retirement	Ages 60~64	Ages 65~69	Ages 70~74	Ages 75~79	Total
M	Legislative officers, public administration officers, community leaders or managers	4.1	6.2	2.1	0.0	3.1
	Professionals	4.1	1.2	5.3	3.5	3.7
	Technicians or professional assistants	10.3	9.9	2.1	2.4	6.1
	Office clerks	11.3	8.6	4.2	7.1	7.8
	Customer service, sales representatives or similar nature	29.9	28.4	32.6	35.3	31.6
	Skilled agricultural and fishery workers	6.2	0.0	0.0	2.4	2.2
	Craftspersons or artisans	7.2	6.2	24.2	25.9	15.9
	Machine operators, drivers or assemblers	8.2	17.3	14.7	4.6	11.2
	Non-technicians	2.1	12.3	10.5	9.4	8.4
	Others	15.5	7.4	4.3	9.4	9.2
	Unemployed	0.0	0.0	0.0	0.0	0.0
	House chores	1.1	2.5	0.0	0.0	0.8
F	Legislative officers, public administration officers, community leaders or managers	2.0	0.9	0.7	2.0	1.4
	Professionals	4.8	4.6	6.8	6.9	5.4
	Technicians or professional assistants	4.8	3.7	4.1	2.0	3.9
	Office clerks	26.2	13.4	13.0	4.0	16.5
	Customer service, sales representatives or similar nature	25.8	24.4	15.1	12.8	21.4
	Skilled agricultural and fishery workers	0.4	0.5	2.7	5.0	1.5
	Craftspersons or artisans	7.5	10.6	23.3	26.7	14.4
	Machine operators, drivers or assemblers	1.2	1.4	1.4	0.0	1.1
	Non-technicians	9.1	17.0	10.3	9.8	11.9
	Others	4.8	9.2	3.4	14.9	7.3
	Unemployed	0.0	0.0	0.8	1.0	0.3
	House chores	13.4	14.3	18.5	14.9	14.9

Table 3-4-1-7 Work status of seniors in each age group (%)

Gender	Work status	Ages 60~64	Ages 65~69	Ages 70~74	Ages 75~79	Total
M	Regular work	44.3	33.3	5.3	2.4	21.5
	No regular work	6.2	6.2	2.1	0.0	3.6
	No work	49.5	60.5	92.6	97.6	74.9
F	Regular work	29.8	10.1	8.2	5.9	16.1
	No regular work	7.1	6.9	6.2	4.0	6.4
	No work	63.1	82.9	85.6	90.1	77.5

Table 3-4-1-8 Average working days per week among seniors with regular work in each age group (%)

Gender	Working days (n)	Ages 60~64	Ages 65~69	Ages 70~74	Ages 75~79	Total
M	2 days or less	2.3	3.7	0.0	0.0	2.6
	3 or 4 days	0.0	11.1	40.0	50.0	7.8
	5 days	51.2	33.3	40.0	0.0	42.9
	6 days	46.5	40.7	20.0	50.0	42.9
	7 days	0.0	11.1	0.0	0.0	3.9
F	2 days or less	2.7	4.5	8.3	33.3	5.2
	3 or 4 days	5.3	9.1	16.7	16.7	7.8
	5 days	54.7	22.7	33.3	33.3	45.2
	6 days	33.3	54.5	16.7	0.0	33.9
	7 days	4.0	9.1	25.0	16.7	7.8

Note : 3 or 4 days referred to 2.1~4 days; 5 days referred to 4.1~5 days; and so forth.

Table 3-4-1-9 Average working hours per day among seniors with regular work in each age group (%)

Gender	Working hours (n)	Ages 60~64	Ages 65~69	Ages 70~74	Ages 75~79	Total
M	Less than 5 hours	4.7	25.9	20.0	50.0	14.3
	5~9 hours	90.7	55.6	60.0	0.0	74.0
	9~10 hours	4.7	11.1	20.0	0.0	7.8
	10 hours or more	0.0	7.4	0.0	50.0	3.9
F	Less than 5 hours	16.0	27.3	66.7	100.0	27.8
	5~9 hours	74.7	59.1	25.0	0.0	62.6
	9~10 hours	5.3	9.1	0.0	0.0	5.2
	10 hours or more	4.0	4.5	8.3	0.0	4.3

Note : Less than 5 hours referred to no more than 5 hours; 5~9 hours included 5 hours and 5.1~8.9 hours; and so forth.

2. Lifestyle

Table 3-4-2-1 Average sleep time per day (%)

Gender	Age group (years)	Subjects (n)	Less than 6 hours	6~9 hours	9 hours or more
M	60~64	97	5.2	82.5	12.4
	65~69	81	8.6	77.8	13.6
	70~74	95	2.1	81.1	16.8
	75~79	85	3.5	67.1	29.4
F	60~64	252	15.5	79.0	5.5
	65~69	217	11.5	82.0	6.5
	70~74	146	15.8	78.8	5.5
	75~79	101	23.8	69.3	6.9
Total		1074	11.9	78.1	10.0

Table 3-4-2-2 Major transportation means for commuting (%)

Gender	Age group (years)	Subjects (n)	Walking	Bicycling	Motorcycling	Driving	By public transport, private car, motorcycle	Others
M	60~64	97	44.3	0.0	20.6	12.4	22.7	0.0
	65~69	81	42.0	1.2	11.1	6.2	39.5	0.0
	70~74	95	38.9	0.0	6.3	2.1	52.6	0.0
	75~79	85	52.9	0.0	0.0	0.0	47.1	0.0
Total		358	44.4	0.3	9.8	5.3	40.2	0.0
F	60~64	252	57.1	0.0	5.2	5.6	31.7	0.4
	65~69	217	51.2	0.0	3.2	1.8	43.8	0.0
	70~74	146	57.5	0.0	0.7	0.7	41.1	0.0
	75~79	101	60.4	0.0	0.0	0.0	39.6	0.0
Total		716	55.9	0.0	2.9	2.7	38.4	0.1

Table 3-4-2-3 Average days per week of walking or bicycling (%)

Gender	Age group (years)	Subjects (n)	0~2 days	3~5 days	6~7 days
M	60~64	97	24.8	22.6	52.6
	65~69	81	13.5	27.2	59.3
	70~74	95	22.1	23.2	54.7
	75~79	85	13.0	16.4	70.6
	Total	358	18.7	22.4	58.9
F	60~64	252	14.3	21.1	64.6
	65~69	217	18.9	14.7	66.4
	70~74	146	19.2	17.1	63.7
	75~79	101	16.9	19.0	64.1
	Total	716	17.0	18.5	64.5

Table 3-4-2-4 Average accumulated daily time of walking or bicycling (%)

Gender	Age group (years)	Subjects (n)	Less than 10 consecutive minutes	10~30 minutes	30 minutes to 1 hour	1~2 hours	2 hours or more
M	60~64	97	14.4	17.5	27.8	28.9	11.4
	65~69	81	7.4	14.9	32.1	32.1	13.5
	70~74	95	9.5	20.0	33.7	22.1	14.7
	75~79	85	10.6	4.8	24.7	37.7	22.2
	Total	358	10.6	14.3	29.8	28.9	14.6
F	60~64	252	9.1	13.9	29.8	25.4	21.8
	65~69	217	11.1	9.7	26.7	35.5	17.0
	70~74	146	8.9	11.0	24.7	35.6	19.8
	75~79	101	5.9	17.8	36.6	21.8	17.9
	Total	716	9.7	13.2	29.1	30.0	18.1

Note: 10~30 minutes referred to 10 minutes to less than 30 minutes; and so forth.

Table 3-4-2-5 Average sitting hours per day (%)

Gender	Age group (years)	Subjects (n)	Less than 3 hours	3~6 hours	6~9 hours	9~12 hours	12 hours or more
M	60~64	97	14.4	44.3	29.8	8.3	3.2
	65~69	81	8.6	45.6	35.7	7.4	2.7
	70~74	95	12.6	51.6	28.5	4.2	3.1
	75~79	85	9.4	45.9	32.9	9.5	2.3
F	60~64	252	12.7	46.8	35.3	2.8	2.4
	65~69	217	16.6	48.4	26.3	7.0	1.7
	70~74	146	20.5	48.7	27.5	2.9	0.4
	75~79	101	14.9	49.5	27.7	6.0	1.9
Total		1074	14.3	47.7	30.4	5.4	2.2

Note : Less than 3 hrs referred to 0 to 2 hours and 50 minutes; 3~6 hours referred to 3 hours (included) to 5 hours and 50 minutes; and so forth.

Table 3-4-2-6 Activities during leisure time (%)

Gender	Age group (years)	Subjects (n)	Watching TV	Listening to the radio, music	Using laptop/ mobile/ game console	Reading books, newspaper	Chatting, social gathering	Physical exercise	House chores	Sleeping
M	60~64	97	81.4	14.4	30.9	32.0	6.2	49.5	17.5	7.2
	65~69	81	76.5	8.6	37.0	25.9	11.1	42.0	18.5	11.1
	70~74	95	77.9	15.8	26.3	27.4	22.1	30.5	29.5	16.8
	75~79	85	70.6	12.9	21.2	29.4	23.5	22.4	14.1	17.6
F	60~64	252	73.0	17.1	46.8	12.3	12.7	23.8	43.7	7.1
	65~69	217	68.7	18.4	34.1	19.8	16.6	22.6	41.5	8.8
	70~74	146	74.0	14.4	35.6	19.9	25.3	24.7	41.8	5.5
	75~79	101	76.2	12.9	25.7	13.9	25.7	23.8	33.7	6.9
Total		1074	73.8	15.3	34.7	20.5	17.4	27.8	34.2	9.2

Table 3-4-2-7 Average frequency of physical exercise per week (%)

Gender	Age group (years)	Subjects (n)	7 times or more/week	6 times/week	5 times/week	4 times/week	3 times/week	2 times/week	1 time/week	Less than 1 time/week	Less than 1 time/month	Never
M	60~64	97	26.8	16.5	18.6	6.2	12.4	5.2	3.1	0.0	1.0	10.3
	65~69	81	29.6	18.5	17.3	7.4	11.1	6.2	2.5	1.2	0.0	6.2
	70~74	95	45.3	7.4	12.6	5.3	13.7	3.2	4.2	0.0	2.1	6.3
	75~79	85	67.1	4.7	11.8	1.2	12.9	0.0	0.0	0.0	0.0	2.4
F	60~64	252	28.6	7.5	11.1	16.7	12.7	7.5	5.6	1.6	1.6	7.1
	65~69	217	35.9	10.1	11.5	12.0	11.5	6.5	3.2	1.4	2.3	5.5
	70~74	146	39.0	13.0	15.8	8.9	9.6	5.5	0.7	0.7	0.7	6.2
	75~79	101	47.5	14.9	9.9	7.9	7.9	5.0	1.0	0.0	0.0	5.9
Total		1074	37.7	10.9	13.0	10.0	11.5	5.5	3.0	0.8	1.2	6.4

Table 3-4-2-8 Duration of each session of physical exercise (%)

Gender	Age group (years)	Participants (n)	Less than 30 minutes	30~59 minutes	60~119 minutes	120 minutes or more
M	60~64	87	16.1	33.3	43.7	6.9
	65~69	76	9.2	43.4	34.2	13.2
	70~74	89	27.0	24.7	39.3	9.0
	75~79	83	22.9	38.6	34.9	3.6
F	60~64	234	19.7	35.9	36.3	8.1
	65~69	205	15.6	34.1	43.4	6.8
	70~74	137	13.9	31.4	48.2	6.6
	75~79	95	10.5	47.4	36.8	5.3
Total		1006	17.0	35.6	40.1	7.3

Table 3-4-2-9 Self-perception during physical exercise (%)

Gender	Age group (years)	Participants (n)	Little change in breathing & heart rate	Slightly increased breathing, heart rate and slight sweating	Significantly increased breathing, heart rate and more sweating
M	60~64	87	21.8	47.1	31.0
	65~69	76	32.9	43.4	23.7
	70~74	89	38.2	52.8	9.0
	75~79	83	50.6	48.2	1.2
F	60~64	234	26.1	53.0	20.9
	65~69	205	33.7	52.7	13.7
	70~74	137	37.2	48.9	13.9
	75~79	95	45.3	44.2	10.5
Total		1006	34.2	49.9	15.9

Table 3-4-2-10 Frequent exercisers and non-frequent exercisers (%)

Frequency	Duration	Intensity	Subjects (n)	Percentage (%)
Never	N/A	N/A	68	6.3%
Less than 3 times	Less than 30 minutes	Low	10	0.9%
		Moderate or above	26	2.4%
	30 minutes or more	Low	27	2.5%
		Moderate or above	50	4.7%
3 times or more	Less than 30 minutes	Low	56	5.2%
		Moderate or above	79	7.4%
	30 minutes or more	Low	251	23.4%
		Moderate or above	507	47.2%

Note : Subjects who exercise for 3 or more times per week, each time for 30 minutes or longer with moderate exercise intensity or higher were defined as “frequent exercisers”.

Table 3-4-2-11 Frequent exercisers (%)

Gender		Ages 60~64	Ages 65~69	Ages 70~74	Ages 75~79
M	Subjects (n)	97	81	95	85
	Frequent exercisers (n)	54	44	39	32
	Percentage (%)	55.7	54.3	41.1	37.6
F	Subjects (n)	252	217	146	101
	Frequent exercisers (n)	124	103	66	45
	Percentage (%)	49.2	47.5	45.2	44.6
Total		51.0	49.3	43.6	41.4

Table 3-4-2-12 Duration of persistent physical exercising (%)

Gender	Age group (years)	Participants (n)	None	Less than 1 month	1~3 months	3~6 months	6~12 months	1 year or more
M	60~64	87	2.3	1.1	8.0	2.4	10.3	75.9
	65~69	76	7.9	0.0	2.6	2.6	5.3	81.6
	70~74	89	3.4	3.4	4.5	3.4	6.6	78.7
	75~79	83	3.6	0.0	1.2	1.2	16.9	77.1
F	60~64	234	4.3	2.1	4.3	1.7	8.1	79.5
	65~69	205	3.9	0.5	2.4	2.0	8.3	82.9
	70~74	137	2.9	1.5	3.6	4.4	2.2	85.4
	75~79	95	4.2	3.2	2.1	1.1	2.1	87.3
Total		1006	4.0	1.5	3.6	2.3	7.3	81.3

Table 3-4-2-13 Frequency (days) of doing strength training per week (%)

Gender	Age group (years)	Participants (n)	0 day	1 day	2 days	3 days	4 days	5 days	6 days	7 days
M	60~64	87	48.3	4.6	5.7	9.2	5.7	9.2	5.7	11.5
	65~69	76	64.5	3.9	3.9	7.9	2.6	2.6	2.6	11.8
	70~74	89	75.3	4.5	3.4	4.5	3.4	3.4	0.0	5.6
	75~79	83	81.9	1.2	2.4	2.4	0.0	1.2	1.2	9.6
F	60~64	234	86.3	1.7	3.0	3.0	1.3	1.7	0.0	3.0
	65~69	205	90.2	2.9	2.4	2.0	0.0	0.5	1.0	1.0
	70~74	137	87.6	2.2	4.4	1.5	0.7	0.7	0.7	2.2
	75~79	95	90.5	3.2	1.1	1.1	0.0	1.1	0.0	3.2
Total		1006	81.4	2.8	3.2	3.3	1.4	2.1	1.1	4.7

Table 3-4-2-14 Major physical exercises (%)

Gender	Age group (years)	Subjects (n)	Walking	Running	Hiking, rock climbing	Aerobics	Dance	Martial arts	Qigong	Swimming	None
M	60~64	97	71.1	34.0	14.4	7.2	1.0	13.4	15.5	41.2	9.3
	65~69	81	71.6	27.2	11.1	9.9	3.7	16.0	16.0	38.3	7.4
	70~74	95	74.7	16.8	12.6	16.8	1.1	14.7	9.5	24.2	8.4
	75~79	85	88.2	15.3	16.5	9.4	0.0	12.9	8.2	15.3	0.0
F	60~64	252	73.0	15.1	17.9	19.4	25.4	14.6	15.9	29.8	5.2
	65~69	217	71.0	7.8	14.7	19.4	31.3	20.3	18.9	26.7	6.0
	70~74	146	65.8	4.8	6.2	26.0	26.0	30.1	29.5	23.3	4.8
	75~79	101	66.3	5.0	5.9	29.7	23.8	24.8	30.7	14.9	7.9
Total		1074	72.1	14.1	13.1	18.4	18.5	18.6	18.5	26.9	6.0

Table 3-4-2-15 Major reasons for participating in physical exercises (%)

Gender	Age group (years)	Participants (n)	Random choice	Convenient to practice	Follow the trend	Follow family members, friends or colleagues	Easy to practice	Follow professional advice
M	60~64	88	46.6	25.0	2.3	10.2	9.1	6.8
	65~69	75	57.3	22.7	1.3	2.7	9.3	6.7
	70~74	87	47.1	25.3	2.3	8.0	11.5	5.7
	75~79	85	45.9	22.4	14.1	14.1	3.5	0.0
F	60~64	239	57.7	20.5	0.0	13.4	5.4	2.9
	65~69	204	56.9	12.3	1.0	19.1	6.9	3.9
	70~74	139	60.4	9.4	1.4	17.3	7.2	4.3
	75~79	93	47.3	9.7	2.2	26.9	7.5	6.5
Total		1010	54.1	17.4	2.3	14.8	7.1	4.3

Table 3-4-2-16 Major obstacles for participating in physical exercise (%)

Gender	Age group (years)	Subjects (n)	Busy work	Burden of house chores	Concern of injuries	Financial restraint	Lack of interest	Lack of coaching advice	Lack of venues	Lack of venues nearby	Lack of organization	Lack of events or activities	Lack of diversity, or activities not attractive	Others
M	60~64	97	43.3	21.6	8.2	3.1	7.2	17.5	25.8	16.5	5.2	5.2	11.3	26.8
	65~69	81	30.9	19.8	11.1	6.2	4.9	18.8	17.3	11.1	12.3	2.5	9.9	19.8
	70~74	95	14.7	12.6	21.1	2.1	6.3	16.8	15.8	15.8	7.4	2.1	8.4	32.6
	75~79	85	17.6	23.5	23.5	0.0	10.6	11.8	30.6	12.9	9.4	3.5	11.8	28.2
F	60~64	252	27.4	38.1	16.3	2.2	6.7	20.6	16.7	13.9	7.5	2.4	7.5	22.6
	65~69	217	14.3	30.9	17.5	3.2	2.3	20.7	19.8	14.3	9.7	5.1	6.5	27.2
	70~74	146	8.2	37.0	19.2	0.0	6.8	16.4	17.8	11.3	5.5	4.1	7.5	26.7
	75~79	101	7.9	27.7	18.8	1.0	7.9	13.9	18.8	20.8	5.0	5.9	5.0	32.7
Total	1074	20.1	29.2	17.0	2.1	6.1	18.0	19.6	14.4	7.7	3.8	8.0	26.5	

Table 3-4-2-17 Occurrence of diseases in the past five years (%)

Gender	Age group (years)	Subjects (n)	Yes	No
M	60~64	97	64.9	35.1
	65~69	81	79.0	21.0
	70~74	95	81.1	18.9
	75~79	85	91.8	8.2
F	60~64	252	68.3	31.7
	65~69	217	74.2	25.8
	70~74	146	78.8	21.2
	75~79	101	82.2	17.8
Total	1074	75.7	24.3	

Table 3-4-2-18 Diseases diagnosed in the past five years (%)

Gender	Age group (years)	Subjects diagnosed with diseases (n)	Enteritis, gastritis	Periodontitis	Diabetes	Hyperlipemia	Hypertension	Heart disease	Discopathy	Long-term insomnia	Accidental injuries	Others
M	60~64	63	3.2	6.3	14.3	17.5	42.9	4.8	9.5	3.2	11.1	27.0
	65~69	64	4.7	1.6	15.6	18.8	50.0	7.8	3.1	3.1	7.8	28.1
	70~74	77	6.5	3.9	26.0	20.8	59.7	20.8	10.4	1.3	0.0	20.8
	75~79	78	5.1	1.3	21.8	21.8	56.4	16.7	2.6	3.8	0.0	32.1
F	60~64	172	12.2	4.1	11.0	25.0	32.6	5.8	14.5	7.6	6.4	27.3
	65~69	161	9.3	6.8	11.8	24.2	50.9	8.7	7.5	5.6	5.0	28.0
	70~74	115	9.6	2.6	19.1	23.5	58.3	13.9	13.0	6.1	5.2	17.4
	75~79	83	3.6	3.6	24.1	26.5	61.4	21.7	13.3	1.2	2.4	22.9
Total		813	7.9	4.1	16.7	23.0	49.8	11.7	10.0	4.7	4.8	25.5

Table 3-4-2-19 Previously heard of the “Physical Fitness Study” (%)

Gender	Age group (years)	Subjects (n)	Had previously heard of the Study (%)	Had not heard of the Study (%)
M	60~64	97	54.6	45.4
	65~69	81	60.5	39.5
	70~74	95	35.8	64.2
	75~79	85	35.3	64.7
F	60~64	252	65.5	34.5
	65~69	217	64.1	35.9
	70~74	146	61.6	38.4
	75~79	101	61.4	38.6
Total		1074	57.9	42.1

Table 3-4-2-20 Previously participated in the “Physical Fitness Study” (%)

Gender	Age group (years)	Subjects (n)	Had previously participated in the Study (%)	Had not participated in the Study (%)
M	60~64	97	29.9	70.1
	65~69	81	27.2	72.8
	70~74	95	23.2	76.8
	75~79	85	29.4	70.6
F	60~64	252	41.7	58.3
	65~69	217	41.7	58.3
	70~74	146	49.3	50.7
	75~79	101	56.4	43.6
Total		1074	39.7	60.3

Table 3-4-2-21 Perception of the “Physical Fitness Study” (%)

Gender	Age group (years)	Subjects (n)	Meaningless	Understand physical fitness status of oneself	Recognize the importance of physical exercise	Enhance knowledge of scientific fitness
M	60~64	97	4.1	89.7	70.1	60.8
	65~69	81	2.5	96.3	74.1	67.9
	70~74	95	5.3	91.6	72.6	62.1
	75~79	85	2.4	92.9	77.6	61.2
F	60~64	252	3.2	94.5	77.0	71.0
	65~69	217	2.8	92.2	77.4	71.0
	70~74	146	4.1	87.7	75.3	65.1
	75~79	101	3.0	94.1	82.2	70.3
Total		1074	3.4	92.4	76.0	67.4

3. Anthropometric Measurements

Table 3-4-3-1 Height (cm)

Gender	Age group (years)	n	Mean	SD	P ₃	P ₁₀	P ₂₅	P ₅₀	P ₇₅	P ₉₀	P ₉₇
M	60~64	97	166.5	5.92	154.6	159.2	162.3	167.2	171.2	173.4	177.0
	65~69	81	165.7	7.01	152.7	156.7	160.5	164.8	171.2	175.8	179.0
	70~74	95	163.3	6.05	152.3	155.9	159.1	162.5	167.1	170.9	177.9
	75~79	85	162.7	6.29	150.8	154.9	158.5	162.4	166.4	170.7	178.1
F	60~64	252	154.3	5.41	144.1	147.5	150.5	154.0	158.0	161.4	164.7
	65~69	217	154.1	5.33	144.0	147.3	150.4	154.0	157.3	161.3	165.0
	70~74	146	153.4	5.46	142.7	145.6	149.5	153.5	156.8	160.7	163.4
	75~79	101	152.1	4.71	143.7	145.7	148.6	152.3	155.0	158.4	161.5

Table 3-4-3-2 Sitting height (cm)

Gender	Age group (years)	n	Mean	SD	P ₃	P ₁₀	P ₂₅	P ₅₀	P ₇₅	P ₉₀	P ₉₇
M	60~64	97	89.5	3.48	82.8	84.0	87.4	89.9	92.1	93.7	95.0
	65~69	81	89.4	3.24	83.5	85.2	86.7	89.6	92.0	93.4	95.5
	70~74	95	87.4	3.55	80.7	82.9	85.0	87.4	89.8	91.7	94.6
	75~79	85	86.2	5.27	79.3	82.1	83.8	86.9	88.4	91.9	94.7
F	60~64	252	83.6	3.02	78.5	80.0	81.6	83.8	85.5	87.5	88.9
	65~69	217	83.3	3.88	77.1	79.7	81.5	83.4	85.5	87.3	89.4
	70~74	146	82.5	3.25	76.8	78.2	80.1	82.4	84.4	87.2	89.0
	75~79	101	81.1	2.78	75.8	77.7	79.1	80.8	83.1	84.5	87.1

Table 3-4-3-3 Foot Length (cm)

Gender	Age group (years)	n	Mean	SD	P ₃	P ₁₀	P ₂₅	P ₅₀	P ₇₅	P ₉₀	P ₉₇
M	60~64	97	24.7	1.00	22.7	23.4	24.1	24.8	25.4	25.8	26.4
	65~69	81	24.6	1.28	22.0	23.0	23.7	24.5	25.5	26.0	27.3
	70~74	95	24.3	1.16	22.2	22.7	23.5	24.2	25.0	25.8	26.3
	75~79	85	24.2	1.53	21.5	22.5	23.1	24.1	25.4	26.4	27.3
F	60~64	252	22.6	1.09	20.8	21.3	21.9	22.5	23.3	24.1	24.6
	65~69	216	22.6	1.03	20.6	21.4	22.0	22.7	23.3	23.8	24.6
	70~74	146	22.8	1.04	20.4	21.5	22.3	22.9	23.5	24.2	24.9
	75~79	101	22.6	1.05	20.6	21.3	22.0	22.7	23.3	23.9	24.8

Table 3-4-3-4 Weight (kg)

Gender	Age group (years)	n	Mean	SD	P ₃	P ₁₀	P ₂₅	P ₅₀	P ₇₅	P ₉₀	P ₉₇
M	60~64	97	65.5	7.63	50.5	56.6	59.7	65.5	71.1	75.4	79.3
	65~69	81	64.4	9.03	49.2	53.4	58.7	63.5	67.1	79.7	86.7
	70~74	95	64.1	10.11	48.7	51.9	56.8	62.5	70.2	80.9	86.7
	75~79	85	64.5	9.01	46.9	50.6	59.4	65.1	70.1	77.5	82.7
F	60~64	252	54.6	7.81	42.2	45.4	49.0	53.9	59.5	64.1	71.7
	65~69	217	56.6	8.30	41.9	46.2	50.2	56.1	62.4	67.5	71.5
	70~74	146	56.3	8.27	41.6	45.3	50.9	56.4	61.8	67.1	72.0
	75~79	101	55.8	9.01	40.6	45.1	49.2	54.6	61.6	67.5	75.7

Table 3-4-3-5 BMI

Gender	Age group (years)	n	Mean	SD	P ₃	P ₁₀	P ₂₅	P ₅₀	P ₇₅	P ₉₀	P ₉₇
M	60~64	97	23.8	2.87	18.3	20.2	22.0	23.6	25.9	27.0	28.6
	65~69	81	23.4	2.65	17.7	20.3	21.9	23.4	25.1	27.0	28.8
	70~74	95	24.1	3.54	18.2	19.5	21.5	24.0	26.5	28.1	32.6
	75~79	85	24.3	2.63	18.7	21.1	22.7	24.6	25.8	27.5	29.9
F	60~64	252	22.9	3.00	18.0	19.4	21.0	22.6	24.7	26.7	29.1
	65~69	217	23.8	3.25	18.1	19.8	21.4	23.8	25.9	27.9	30.2
	70~74	146	23.9	3.21	18.4	19.8	21.7	23.8	26.2	28.0	30.6
	75~79	101	24.1	3.63	17.9	19.5	21.9	23.9	26.1	28.5	32.9

Table 3-4-3-6 Weight classification (%)

Gender	Age group (years)	n	Underweight	Normal	Overweight	Obese
M	60~64	97	3.1%	54.6%	37.1%	5.2%
	65~69	81	4.9%	56.8%	32.1%	6.2%
	70~74	95	4.2%	45.3%	41.1%	9.5%
	75~79	85	1.2%	42.4%	51.8%	4.7%
	Total	358	3.4%	49.7%	40.5%	6.4%
F	60~64	252	3.6%	65.1%	26.6%	4.8%
	65~69	217	3.7%	49.8%	37.3%	9.2%
	70~74	146	2.7%	50.7%	37.0%	9.6%
	75~79	101	3.2%	49.4%	36.0%	11.3%
	Total	716	3.5%	55.0%	33.1%	8.4%

Note : Weight Status based on BMI classification: BMI<18.5 is defined as underweight, 18.5≤BMI<24 means normal weight, 24≤BMI<28 is overweight, BMI≥28 is obese.

Table 3-4-3-7 Chest circumference (cm)

Gender	Age group (years)	n	Mean	SD	P ₃	P ₁₀	P ₂₅	P ₅₀	P ₇₅	P ₉₀	P ₉₇
M	60~64	96	92.3	5.84	81.9	84.6	88.3	92.3	95.7	100.1	104.9
	65~69	81	92.5	6.56	78.4	84.5	88.3	92.6	96.9	101.4	105.7
	70~74	95	90.9	6.11	79.2	82.7	86.4	91.0	95.6	99.3	102.6
	75~79	85	90.4	6.39	77.6	82.3	86.3	91.1	94.8	98.4	100.5
F	60~64	252	87.6	6.39	77.0	79.5	83.0	86.8	92.3	96.5	99.9
	65~69	216	88.5	6.63	75.5	80.0	83.8	88.6	92.5	97.3	101.4
	70~74	146	89.2	5.99	77.0	80.0	85.6	89.4	93.3	96.5	99.9
	75~79	101	89.0	6.90	76.0	80.6	84.4	88.3	94.3	99.6	103.6

Table 3-4-3-8 Waist circumference (cm)

Gender	Age group (years)	n	Mean	SD	P ₃	P ₁₀	P ₂₅	P ₅₀	P ₇₅	P ₉₀	P ₉₇
M	60~64	97	86.1	8.64	68.8	74.5	79.7	86.0	92.3	96.5	101.3
	65~69	81	86.4	9.54	64.8	74.6	80.1	87.3	93.5	97.8	105.2
	70~74	95	87.2	11.10	65.5	72.0	80.5	88.0	95.0	102.4	108.3
	75~79	84	88.7	9.17	70.4	77.0	82.5	87.8	95.0	101.8	105.5
F	60~64	252	81.4	8.58	66.1	70.4	75.6	80.9	87.2	92.4	97.7
	65~69	217	84.7	9.39	66.7	72.5	78.0	85.0	90.7	96.7	102.9
	70~74	145	87.0	8.91	67.8	73.9	81.2	87.0	92.8	98.0	105.2
	75~79	101	87.7	10.44	64.7	75.7	80.3	87.4	92.6	102.7	109.8

Table 3-4-3-9 Hip circumference (cm)

Gender	Age group (years)	n	Mean	SD	P ₃	P ₁₀	P ₂₅	P ₅₀	P ₇₅	P ₉₀	P ₉₇
M	60~64	97	93.4	5.01	84.1	86.7	90.0	93.3	96.4	100.1	104.7
	65~69	81	93.0	5.04	84.2	86.8	90.4	92.5	95.9	100.3	103.9
	70~74	95	92.9	6.25	83.4	85.5	88.5	92.0	96.0	102.7	107.0
	75~79	85	92.7	5.44	83.6	85.8	88.7	91.4	97.7	100.1	102.8
F	60~64	252	93.1	5.76	83.4	86.5	89.3	92.5	96.3	100.5	105.9
	65~69	217	94.5	6.43	84.6	86.5	90.2	93.8	98.6	103.1	107.9
	70~74	146	94.2	6.04	84.8	86.1	90.0	94.0	97.7	102.0	106.7
	75~79	101	94.3	7.52	82.5	85.1	89.0	93.1	99.5	103.3	111.8

Table 3-4-3-10 Waist to Hip Ratio (WHR)

Gender	Age group (years)	n	Mean	SD	P ₃	P ₁₀	P ₂₅	P ₅₀	P ₇₅	P ₉₀	P ₉₇
M	60~64	97	0.921	0.064	0.791	0.831	0.877	0.924	0.967	1.000	1.035
	65~69	81	0.927	0.070	0.761	0.828	0.891	0.936	0.970	1.009	1.062
	70~74	95	0.937	0.083	0.777	0.830	0.893	0.940	0.983	1.047	1.096
	75~79	84	0.956	0.068	0.836	0.868	0.900	0.959	0.994	1.056	1.109
F	60~64	252	0.873	0.064	0.745	0.781	0.836	0.878	0.917	0.951	0.983
	65~69	217	0.895	0.072	0.758	0.804	0.847	0.899	0.942	0.994	1.026
	70~74	145	0.919	0.082	0.787	0.830	0.877	0.919	0.965	1.014	1.058
	75~79	101	0.928	0.068	0.743	0.846	0.889	0.933	0.977	1.010	1.043

Table 3-4-3-11 Shoulder width (cm)

Gender	Age group (years)	n	Mean	SD	P ₃	P ₁₀	P ₂₅	P ₅₀	P ₇₅	P ₉₀	P ₉₇
M	60~64	97	38.5	1.73	34.5	36.5	37.5	38.7	39.8	40.4	41.9
	65~69	81	38.3	1.95	34.2	35.7	37.2	38.1	40.0	40.9	41.9
	70~74	95	37.6	2.13	33.3	35.5	36.5	37.7	38.7	39.9	41.2
	75~79	85	37.8	1.80	34.6	35.5	36.3	37.8	39.1	40.1	41.0
F	60~64	252	34.8	1.54	31.6	33.0	33.9	34.9	35.7	36.7	37.6
	65~69	217	34.8	1.45	32.0	33.0	33.7	34.8	35.9	36.6	37.5
	70~74	146	34.5	1.57	31.8	32.6	33.5	34.4	35.7	36.7	37.3
	75~79	101	34.3	1.50	31.3	32.2	33.5	34.3	35.3	36.3	36.9

Table 3-4-3-12 Pelvis width (cm)

Gender	Age group (years)	n	Mean	SD	P ₃	P ₁₀	P ₂₅	P ₅₀	P ₇₅	P ₉₀	P ₉₇
M	60~64	96	29.6	1.96	26.2	27.0	27.8	28.8	29.9	31.0	34.5
	65~69	81	28.5	1.94	25.0	26.4	27.4	28.4	29.6	30.7	32.6
	70~74	94	28.2	1.92	25.0	26.2	27.0	28.0	28.8	30.6	33.6
	75~79	85	27.9	1.53	25.1	25.9	27.1	28.0	28.9	29.9	30.9
F	60~64	252	28.5	2.04	25.3	26.4	27.1	28.2	29.7	31.0	33.0
	65~69	217	28.9	1.98	25.6	26.7	27.5	28.7	29.9	31.5	34.0
	70~74	146	29.0	1.89	26.0	27.0	28.0	28.8	29.7	31.0	33.3
	75~79	101	29.0	1.81	26.1	27.0	27.6	28.8	29.8	31.7	33.2

Table 3-4-3-13 Body fat percentage (%)

Gender	Age group (years)	n	Mean	SD	P ₃	P ₁₀	P ₂₅	P ₅₀	P ₇₅	P ₉₀	P ₉₇
M	60~64	95	22.2	4.88	10.7	15.7	19.8	22.2	25.0	28.7	30.9
	65~69	81	21.8	5.16	10.0	13.9	18.8	22.3	25.1	28.0	30.9
	70~74	86	22.5	5.62	10.1	14.5	19.3	22.6	27.2	29.7	31.9
	75~79	64	22.7	4.69	10.8	16.2	19.8	23.2	26.3	28.1	30.0
F	60~64	248	30.5	4.74	20.2	24.5	27.5	30.8	34.0	36.5	38.8
	65~69	214	32.2	4.73	22.8	25.5	29.5	32.7	35.5	37.7	40.5
	70~74	144	32.1	4.49	22.1	26.4	29.0	32.3	35.1	38.2	39.3
	75~79	93	32.4	5.14	19.1	25.2	29.7	33.6	35.9	38.1	41.1

Table 3-4-3-14 Lean body mass (kg)

Gender	Age group (years)	n	Mean	SD	P ₃	P ₁₀	P ₂₅	P ₅₀	P ₇₅	P ₉₀	P ₉₇
M	60~64	96	50.6	3.99	42.1	45.2	48.1	50.6	53.3	55.4	58.3
	65~69	81	50.0	4.81	42.5	44.2	46.3	49.3	52.9	56.9	61.2
	70~74	86	49.4	5.34	42.1	43.7	45.5	48.0	53.4	58.1	61.2
	75~79	64	49.5	5.29	40.2	42.7	46.7	48.8	53.0	57.5	60.0
F	60~64	248	37.6	3.44	32.3	33.6	35.2	37.3	39.7	42.1	45.4
	65~69	214	38.1	3.63	31.8	33.7	35.4	37.7	40.6	42.7	45.8
	70~74	144	38.0	3.95	30.9	33.1	35.0	38.2	40.4	43.0	44.8
	75~79	93	37.0	3.74	31.6	32.5	34.0	36.5	39.7	41.0	45.2

4. Physiological Function

Table 3-4-4-1 Resting pulse (bpm)

Gender	Age group (years)	n	Mean	SD	P ₃	P ₁₀	P ₂₅	P ₅₀	P ₇₅	P ₉₀	P ₉₇
M	60~64	97	73.9	12.18	49.9	59.0	64.5	74.0	81.5	91.4	98.0
	65~69	81	71.8	10.63	54.0	57.2	64.5	73.0	79.5	85.0	92.2
	70~74	95	74.1	10.63	54.9	61.0	65.0	72.0	83.0	89.0	96.1
	75~79	85	71.6	10.92	49.6	57.2	64.0	72.0	80.0	86.0	91.7
F	60~64	252	72.8	9.63	55.6	61.0	66.3	72.0	79.0	85.7	92.0
	65~69	217	73.2	10.15	56.1	60.8	66.0	73.0	80.0	85.2	97.5
	70~74	146	73.7	9.88	55.4	60.0	68.0	74.0	80.0	86.0	95.2
	75~79	101	74.8	9.97	57.1	63.0	68.5	73.0	82.5	88.0	96.9

Table 3-4-4-2 Systolic blood pressure (mmHg)

Gender	Age group (years)	n	Mean	SD	P ₃	P ₁₀	P ₂₅	P ₅₀	P ₇₅	P ₉₀	P ₉₇
M	60~64	97	136.2	14.54	105.9	115.8	128.0	136.0	148.0	154.2	159.3
	65~69	81	137.4	16.44	106.5	114.2	127.5	135.0	149.0	157.0	172.9
	70~74	94	137.8	15.53	110.7	115.0	126.0	139.0	149.0	157.5	166.6
	75~79	83	136.8	13.54	108.1	119.4	128.0	140.0	146.0	154.6	159.5
F	60~64	251	130.7	17.42	97.1	108.2	119.0	132.0	142.0	153.8	163.4
	65~69	215	137.5	16.43	104.5	116.6	127.0	137.0	149.0	159.0	169.0
	70~74	146	134.9	15.44	107.4	114.0	124.0	135.5	145.0	155.3	165.6
	75~79	101	137.9	18.13	102.1	113.2	125.0	137.0	152.0	159.0	174.6

Table 3-4-4-3 Diastolic blood pressure (mmHg)

Gender	Age group (years)	n	Mean	SD	P ₃	P ₁₀	P ₂₅	P ₅₀	P ₇₅	P ₉₀	P ₉₇
M	60~64	97	78.0	8.77	57.9	67.8	72.0	79.0	84.0	89.0	94.0
	65~69	81	76.2	8.40	59.4	64.2	70.0	77.0	82.0	86.6	91.0
	70~74	95	73.1	9.31	54.8	61.0	66.0	72.0	81.0	85.0	89.4
	75~79	85	70.7	8.25	55.2	60.0	63.5	70.0	78.0	81.0	84.4
F	60~64	252	73.5	10.12	54.0	61.0	67.0	74.0	80.0	86.7	94.0
	65~69	217	75.3	10.40	57.0	62.0	69.0	75.0	83.0	89.2	97.0
	70~74	146	72.1	8.86	54.0	60.7	67.0	71.0	79.3	83.3	87.0
	75~79	101	69.4	9.61	51.1	57.2	62.5	69.0	75.5	82.8	86.9

Table 3-4-4-4 Pressure difference (mmHg)

Gender	Age group (years)	n	Mean	SD	P ₃	P ₁₀	P ₂₅	P ₅₀	P ₇₅	P ₉₀	P ₉₇
M	60~64	97	58.2	10.56	38.0	45.8	49.0	57.0	66.0	73.4	78.1
	65~69	81	61.2	12.41	39.7	48.0	51.5	58.0	69.0	75.8	89.7
	70~74	95	65.6	15.15	44.0	50.6	56.0	62.0	75.0	83.2	99.8
	75~79	85	67.3	14.95	41.6	50.0	58.0	64.0	77.0	88.4	100.4
F	60~64	252	57.5	12.80	36.6	42.0	48.3	56.0	67.0	75.0	82.4
	65~69	217	62.7	12.63	42.0	47.0	53.0	62.0	71.0	80.0	87.5
	70~74	146	62.8	13.49	42.0	44.0	51.8	63.0	72.0	80.0	92.0
	75~79	101	68.4	17.30	37.1	46.2	55.5	65.0	81.0	94.6	100.9

Table 3-4-4-5 Vital capacity (ml)

Gender	Age group (years)	n	Mean	SD	P ₃	P ₁₀	P ₂₅	P ₅₀	P ₇₅	P ₉₀	P ₉₇
M	60~64	97	3006.4	722.15	1432.3	2138.6	2542.0	3054.0	3410.0	3735.6	4897.8
	65~69	80	2772.9	885.70	1060.8	1658.1	2122.0	2683.5	3341.8	3929.8	4487.8
	70~74	95	2287.6	775.84	901.88	1283.2	1726.0	2267.0	2830.0	3242.4	3947.7
	75~79	85	2175.3	675.64	996.6	1448.0	1672.5	2025.0	2744.5	3152.4	3288.8
F	60~64	252	1982.5	530.95	1020.6	1288.0	1674.0	2003.5	2287.3	2557.1	3146.7
	65~69	217	1829.8	457.40	1051.0	1233.6	1504.5	1825.0	2150.0	2378.0	2758.5
	70~74	146	1664.6	502.00	765.33	991.8	1366.3	1637.5	1951.3	2286.4	2698.9
	75~79	101	1448.2	428.58	804.50	933.0	1045.0	1485.0	1741.0	2031.4	2233.9

Table 3-4-4-6 Vital capacity/weight (ml/kg)

Gender	Age group (years)	n	Mean	SD	P ₃	P ₁₀	P ₂₅	P ₅₀	P ₇₅	P ₉₀	P ₉₇
M	60~64	97	46.3	12.03	24.4	29.5	37.7	46.7	54.0	61.5	73.8
	65~69	80	43.4	13.87	16.9	26.5	33.8	40.7	54.5	60.9	72.5
	70~74	95	36.0	12.14	15.3	22.4	26.2	35.4	44.8	49.3	67.3
	75~79	85	34.1	10.56	15.9	19.7	25.8	33.6	42.6	49.2	52.5
F	60~64	252	36.9	10.73	16.9	23.7	30.1	36.2	43.0	50.1	58.8
	65~69	217	33.1	9.64	16.2	21.2	25.4	33.0	39.7	45.3	51.5
	70~74	146	30.1	10.07	14.2	18.0	23.2	29.2	35.3	43.2	53.5
	75~79	101	26.7	9.06	11.0	15.8	19.8	25.2	33.9	38.2	46.3

Table 3-4-4-7 Two-minute high-knee running in place (times)

Gender	Age group (years)	n	Mean	SD	P ₃	P ₁₀	P ₂₅	P ₅₀	P ₇₅	P ₉₀	P ₉₇
M	60~64	89	94.3	22.83	44.3	66.0	78.0	95.0	107.0	122.0	143.3
	65~69	74	89.1	24.85	34.0	56.0	76.0	90.0	102.3	117.5	127.3
	70~74	89	75.5	27.11	12.0	36.0	54.0	81.0	94.0	109.0	121.5
	75~79	80	74.3	22.75	33.3	45.0	61.0	70.5	91.5	103.0	123.6
F	60~64	235	90.9	25.02	38.1	64.2	78.0	92.0	104.0	116.0	148.3
	65~69	194	87.0	23.80	36.8	63.0	73.8	86.5	101.0	110.0	139.6
	70~74	128	87.1	23.16	39.9	59.9	71.5	87.0	100.0	115.0	138.1
	75~79	78	79.6	25.91	30.1	51.7	63.5	79.0	96.3	105.1	144.8

5. Physical Fitness

Table 3-4-5-1 Grip strength (kg)

Gender	Age group (years)	n	Mean	SD	P ₃	P ₁₀	P ₂₅	P ₅₀	P ₇₅	P ₉₀	P ₉₇
M	60~64	97	36.4	7.03	21.8	28.2	31.8	36.1	41.3	46.1	50.7
	65~69	81	33.6	7.41	17.7	25.5	29.5	33.5	38.3	42.3	50.5
	70~74	95	30.6	8.83	12.1	18.6	25.7	29.5	37.6	43.6	47.2
	75~79	85	28.3	6.92	13.7	20.6	23.2	27.8	33.4	38.7	40.4
F	60~64	252	21.2	4.11	12.8	16.2	18.7	21.1	23.7	26.3	29.0
	65~69	217	20.4	4.23	12.8	15.6	17.4	20.2	23.0	26.5	29.4
	70~74	146	20.5	4.39	11.7	14.8	17.8	20.7	23.0	26.3	29.4
	75~79	101	18.9	4.22	11.5	13.2	15.5	19.1	21.4	25.6	28.1

Table 3-4-5-2 30-second chair stand (times)

Gender	Age group (years)	n	Mean	SD	P ₃	P ₁₀	P ₂₅	P ₅₀	P ₇₅	P ₉₀	P ₉₇
M	60~64	91	18.0	5.17	10.8	12.0	14.0	17.0	22.0	24.8	29.0
	65~69	70	16.8	4.42	8.3	12.0	13.8	16.0	20.0	23.9	25.0
	70~74	87	15.4	4.23	8.3	10.0	13.0	15.0	18.0	22.0	25.4
	75~79	78	16.2	6.30	8.1	10.0	11.8	16.0	18.3	24.6	34.6
F	60~64	228	17.0	4.86	9.9	11.9	13.0	16.0	20.0	23.0	29.0
	65~69	189	16.4	4.77	8.7	11.0	13.0	16.0	20.0	23.0	27.3
	70~74	129	15.9	4.61	10.0	11.0	12.5	15.0	18.0	22.0	30.0
	75~79	81	15.4	4.46	8.0	10.2	12.0	14.0	18.0	20.8	26.5

Table 3-4-5-3 Sit and reach (cm)

Gender	Age group (years)	n	Mean	SD	P ₃	P ₁₀	P ₂₅	P ₅₀	P ₇₅	P ₉₀	P ₉₇
M	60~64	96	0.6	9.61	-17.3	-12.2	-6.9	1.0	7.1	12.9	20.3
	65~69	76	-2.9	8.97	-14.7	-12.7	-10.1	-2.6	3.9	10.9	19.1
	70~74	84	-4.7	9.33	-19.3	-16.6	-11.5	-5.8	1.4	8.6	14.8
	75~79	79	-7.3	8.37	-19.7	-16.8	-12.4	-9.7	-2.8	5.6	13.3
F	60~64	247	6.7	10.01	-16.0	-7.4	0.6	8.2	13.5	19.4	23.2
	65~69	211	6.2	8.83	-10.9	-6.7	0.1	7.2	12.8	17.7	21.3
	70~74	142	5.3	9.08	-17.2	-7.8	0.3	6.7	10.7	15.8	20.5
	75~79	92	4.4	9.12	-13.2	-9.0	-1.4	4.7	11.6	16.6	19.0

Table 3-4-5-4 Choice reaction time (sec)

Gender	Age group (years)	n	Mean	SD	P ₃	P ₁₀	P ₂₅	P ₅₀	P ₇₅	P ₉₀	P ₉₇
M	60~64	97	0.48	0.079	0.35	0.38	0.42	0.48	0.54	0.60	0.66
	65~69	81	0.51	0.101	0.38	0.41	0.45	0.50	0.55	0.64	0.82
	70~74	95	0.58	0.109	0.40	0.45	0.51	0.57	0.65	0.71	0.87
	75~79	84	0.63	0.124	0.42	0.49	0.54	0.63	0.71	0.80	0.85
F	60~64	252	0.52	0.099	0.40	0.43	0.46	0.51	0.56	0.63	0.80
	65~69	215	0.55	0.111	0.41	0.45	0.48	0.53	0.59	0.68	0.78
	70~74	145	0.56	0.099	0.42	0.46	0.50	0.54	0.61	0.67	0.83
	75~79	100	0.61	0.106	0.45	0.48	0.53	0.59	0.66	0.75	0.85

Table 3-4-5-5 One foot stands with eyes closed (sec)

Gender	Age group (years)	n	Mean	SD	P ₃	P ₁₀	P ₂₅	P ₅₀	P ₇₅	P ₉₀	P ₉₇
M	60~64	96	12.4	11.53	3.0	4.0	5.0	8.0	13.8	26.6	47.1
	65~69	78	8.6	7.21	3.0	3.0	4.0	6.5	10.0	18.1	33.6
	70~74	89	5.7	4.18	1.0	2.0	3.0	4.0	7.0	13.0	18.9
	75~79	79	6.1	4.82	1.0	2.0	3.0	4.0	8.0	11.0	23.0
F	60~64	242	9.8	6.61	3.0	3.0	5.0	7.0	12.0	19.7	26.7
	65~69	203	8.2	5.81	2.0	3.0	4.0	6.0	10.0	15.0	23.9
	70~74	140	6.2	4.02	2.0	3.0	3.0	5.0	8.0	10.0	17.8
	75~79	90	4.8	3.11	1.0	2.0	3.0	4.0	6.0	8.9	12.0



Part IV
Appendix

Appendix 1: Data Registration Manual of 2020 Physical Fitness Study of Macao SAR Residents

I. Young Children





歡迎閣下參加2020年澳門市民體質監測！澳門市民體質監測是特區政府為推動大眾健身活動的開展而進行的調查研究。在此首先感謝閣下對監測的支持並認真、如實地填寫問卷，我們保證對閣下的個人資料保密，有關資料不會獨立出現或使用，它將是整體數據的組成部分。再次對閣下的真誠參與表示感謝！

如對調查內容和檢測項目有任何疑問，歡迎向體育局運動醫學中心垂詢！

電話：28810896，88934540

Thank you for participating in our 2020 Physical Fitness Study! This study is organized by the Macao SAR Government to promote Sports for All. We are grateful for your participation. Your honesty and sincerity in filling out the questionnaire are appreciated. We promise to keep your personal data confidential and we will not publish or use your data individually. It will only be used as part of the whole study for statistical purposes. Again, we would like to extend our most sincere gratitude for your participation!

For any enquiries regarding the questionnaire or testing items, please feel free to contact Sports Medicine Centre of Macao Sports Bureau!
Telephone: 28810896, 88934540

2020年澳門市民體質監測數據登錄冊

Data Registration Manual of
2020 Physical Fitness Study of Macao SAR Residents

體育局轄下運動醫學中心預先聲明

Declaration
Sports Medicine Centre of Macao Sports Bureau

本聲明旨在向個人資料當事人或相關家長或監護人確保遵守第8/2005號法律“個人資料保護法”所規範的事宜。

This declaration is intended to assure data subjects or their parents or guardians that we will strictly comply with the relevant provisions of Act 8/2005 - Personal Data Protection Act.

1. 處理個人資料的負責人—體育局，地址設於澳門羅理基博士大馬路818號。代表—體育局局長。

Personal data controller: Macao Sports Bureau, at Av. Dr. Rodrigo Rodrigues, n.º 818, Macao.
Representative - President of Macao Sports Bureau.

2. 處理個人資料的目的—進行澳門市民體質監測，以便為制定日後關於體育及醫療護理的政策提供科學數據。收集的數據旨在更新僅為統計用途的數據庫。

Purposes of processing personal data: To conduct the physical fitness study for Macao residents, and provide scientific references for the development of relevant policies regarding sports and medical care. Data collected through the physical fitness study will only be used to update the database for statistical purposes.

3. 個人資料當事人類別—參與是次計劃的澳門居民（隨年齡抽樣）。

Categories of subjects with personal data: Macao residents participated in the study (random sampling by age).

4. 個人資料接收者—個人資料當事人（或相關家長或監護人），運動醫學中心及國家體育總局體育科學研究所。

Personal data recipients: Data subjects (or their parents or guardians), Sports Medicine Centre and China Institute of Sport Science.

5. 接收及處理個人資料的條件—個人資料當事人（或相關家長或監護人）享有第8/2005號法律賦予的所有權利如查閱權及更正所收集的個人資料。運動醫學中心承諾對不正確的數據進行更正，刪除或封鎖。

Conditions of receiving and processing personal data: Data subjects (or their parents or guardians) are entitled by Act 8/2005 - Personal Data Protection Act to the rights to access and rectify their own personal data collected. The Sports Medicine Centre hereby commits to take proper measures to rectify, delete or block any incorrect data.

幼兒(3~6歲)
Young Children (aged 3~6)

6.處理個人資料的安全和保密性—對處理及編輯個人資料絕對保密及採取適當措施以確保其安全。

Security and confidentiality of processing personal data: Appropriate measures are implemented to process and edit the personal data to ensure strict confidentiality, safety and security of the data.

本人已明白上述內容權益

I, the undersigned, am aware of the contents and my legal rights in the above declaration.

(個人資料當事人或家長或監護人簽名)
(Signature of subject providing personal
data/parents/guardian)

_____/_____/_____
(日) (月) (年)
(DD) (MM) (YY)

姓名：	_____
Name:	_____
性別：	_____
Gender:	_____
年齡：	_____ (歲)
Age:	_____ (years)
就讀幼稚園：	_____
Kindergarten:	_____
聯繫電話：	_____
Phone:	_____

2020年澳門市民體質監測數據登錄冊

Data Registration Manual of
2020 Physical Fitness Study of Macao SAR Residents

一.分類編碼（由幼兒家長填寫）

General Information (to be filled in by parents)

填寫方法：

填寫選擇題時請將選擇答案的序號填入相應的方格中，如選答案（1），則在方格內填1；序號為兩位數時，兩位數字填入同一方格，如選項為（11），則將 填入同一方格，即填為 。在填寫多項選擇題時，如果僅選擇一個或兩個答案，則應在剩餘方格內填0。

Instructions for filling:

Please fill in the boxes with the corresponding numbers. For example, if the chosen answer is (1), fill in the box with "1". If the chosen option is a two digit number, write both digits in the same box. e.g. If the chosen option is (11), fill in the box with . For multiple choice questions, if only one or two option(s) were chosen, please fill in the remaining blank box(es) with "0".

(一) 幼兒本人資料 Personal Information of Young Child

1. 幼兒澳門居民身份證號碼 Macao ID card number	<input type="text"/> <input type="text"/> <input type="text"/> <input type="text"/> <input type="text"/> <input type="text"/> <input type="text"/> <input type="text"/>
2. 幼兒性別 Gender	(1) 男 Male <input type="checkbox"/> (2) 女 Female <input type="checkbox"/>
3. 幼兒出生日期 Date of birth	<input type="text"/> <input type="text"/> <input type="text"/> <input type="text"/> 年 Y <input type="text"/> <input type="text"/> 月 M <input type="text"/> <input type="text"/> 日 D
4. 測試日期（由監測人員填寫） Examination date (to be filled in by examiner)	<input type="text"/> <input type="text"/> <input type="text"/> <input type="text"/> 年 Y <input type="text"/> <input type="text"/> 月 M <input type="text"/> <input type="text"/> 日 D
5. 幼稚園編碼（由監測人員填寫） Kindergarten code number (filled in by examiner)	<input type="text"/> <input type="text"/> <input type="text"/> <input type="text"/>
6. 測試序號（由監測人員填寫） Serial number (filled in by examiner)	<input type="text"/> <input type="text"/> <input type="text"/> <input type="text"/>
7. 幼兒居住在澳門的年限（年）（指幼兒連續在澳門居住的年限，如果離開澳門的時間超過1年，則要由回澳門居住起重新計算居澳年限） Years of residence in Macao (It refers to years of continuous residence in Macao. If the child had left Macao for over 1 year, years of residence in Macao should be recalculated from the time of returning to Macao.)	<input type="text"/>

幼兒(3~6歲)
Young Children (aged 3~6)

<p>8. 幼兒出生地 Place of birth</p> <p>(1) 中國大陸 (2) 澳門 (3) 香港 (4) 葡萄牙 (5) 其他 Mainland China Macao Hong Kong Portugal Others</p>	<input style="width: 40px; height: 25px;" type="checkbox"/>
<p>9. 幼兒居住地所屬堂區 Parish of residence</p> <p>(1) 聖方濟各堂區 (路環) Paróquia de São Francisco Xavier (Coloane)</p> <p>(2) 聖嘉模堂區 (氹仔) Paróquia de Nossa Senhora do Carmo (Taipa)</p> <p>(3) 風順堂區 (包括媽閣山、西望洋山、下環及內港一帶) Paróquia de S. Lourenço (Zonas das Colinas da Barra e da Penha, da Praia do Manduco e do Porto Interior)</p> <p>(4) 大堂區 (新馬路一帶、南灣、水坑尾、新口岸南北地段及南灣湖發展區) Paróquia da Sé Catedral (Zonas da Almeida Ribeiro, da Praia Grande, da Rua do Campo, dos Lotes norte e sul do Porto Exterior e da Zona do Lago Nam Van)</p> <p>(5) 花王堂區 (聖安多尼堂區, 在澳門西部, 包括高士德大馬路、新橋和沙梨頭) Paróquia de Santo António (Zonas da Freguesia de Santo António, do Oeste de Macau, incluindo Av. Horta e Costa, de San Kiu e do Patane)</p> <p>(6) 望德堂區 (包括荷蘭園、松山一帶) Paróquia de S. Lázaro (Zona do Conselheiro Ferreira de Almeida e da Colina da Guia)</p> <p>(7) 花地瑪堂區 (俗稱北區, 包括青洲、台山、黑沙環、筷子基和水塘) Paróquia de Nossa Senhora de Fátima (Zonas do Norte, incluindo Ilha Verde, Tamagnini Barbosa, Areia Preta, Fái Chi Kei e Reservatório)</p>	<input style="width: 40px; height: 25px;" type="checkbox"/>
<p>10. 幼兒出生時體重(kg) (如無法準確回答, 請填寫99.9) Birth weight (kg) (If not sure, please fill in 99.9)</p>	<input style="width: 30px; height: 25px;" type="text"/> <input style="width: 30px; height: 25px;" type="text"/> . <input style="width: 30px; height: 25px;" type="text"/>
<p>11. 幼兒出生時身長(cm) (如無法準確回答, 請填寫99.9) Birth length (cm) (If not sure, please fill in 99.9)</p>	<input style="width: 30px; height: 25px;" type="text"/> <input style="width: 30px; height: 25px;" type="text"/> . <input style="width: 30px; height: 25px;" type="text"/>
<p>12. 幼兒出生時胎齡 Gestational age</p> <p>(1) 小於正常胎齡 (早產: 比預產期提前2周出生) Early-term (birth at least two weeks before term)</p> <p>(2) 正常胎齡 (足月: 在預產期前後2周內出生) Full-term (birth within two weeks of expectancy date)</p> <p>(3) 大於正常胎齡 (過期產: 晚於預產期2周出生) Late-term (birth at least two weeks after term)</p>	<input style="width: 40px; height: 25px;" type="checkbox"/>

2020年澳門市民體質監測數據登錄冊

Data Registration Manual of
2020 Physical Fitness Study of Macao SAR Residents

13. 幼兒出生後4個月內餵養方式 The child's feeding pattern within 4 months after birth	<input type="checkbox"/>	
(1) 母乳餵養 Breast feeding	(2) 人工餵養 Formula feeding	
(3) 混合餵養 Mixed feeding		
14. 幼兒曾患過何種疾病（經醫院確診的疾病）（選擇“無”者請直接回答問題第16題） Does the child have any hospital-diagnosed diseases? (If the answer is “no”, skip to Question 16)	<input type="checkbox"/>	
(1) 有 Yes	(2) 無 No	
15. 患病種類（患病者按主次順序，最多可填寫3項） Diseases suffered (in order of precedence, choose up to 3 diseases)	<input type="checkbox"/> <input type="checkbox"/> <input type="checkbox"/>	
(1) 急性支氣管炎 Acute bronchitis	(2) 肺炎 Pneumonia	(3) 哮喘 Asthma
(4) 過敏性鼻炎 Allergic rhinitis	(5) 積食 Indigestion	(6) 腹瀉病 Diarrhea
(7) 腸胃炎 Gastroenteritis	(8) 腎炎 Nephritis	(9) 手足口病 Hand, foot and mouth disease (HFMD)
(10) 濕疹 Eczema	(11) 中耳炎 Otitis media	(12) 腦膜炎 Meningitis
(13) 佝僂病 Rachitis	(14) 貧血 Anemia	(15) 心臟病 Heart disease
(16) 癲癇 Epilepsy	(17) 糖尿病 Diabetes	(18) 甲狀腺功能減低症 Hypothyroidism
(19) 泌尿道感染 Urinary tract infection	(20) 過敏性紫癜 Henoch-Schonlein purpura (HSP)	(21) 幼年類風濕性關節炎 Juvenile rheumatoid arthritis (JRA)
(22) 意外傷害(造成人體的損傷而需要醫治或影響了正常的活動) Accidental injury (injury to the body that needs treatment, or injury that affects normal activities)	(23) 其他 Others	
16. 幼兒是否有親兄弟姐妹? Does the child have any sibling(s)?	<input type="checkbox"/>	
(1) 沒有 No	(2) 有1個 1	(3) 有2個或以上 2 or more
17. 幼兒是否有影響開展體育活動的先天性疾病或者殘疾? Does the child have any congenital disease or disability that affects physical activity?	<input type="checkbox"/>	
(1) 沒有 No	(2) 有 (請注明) Yes (Please specify _____)	

幼兒(3~6歲)
Young Children (aged 3~6)

請根據幼兒近半年的情況回答以下各部份的問題

Please answer the following questions according to the subject's status in the past half year:

<p>18. 幼兒上幼稚園情況 Kindergarten attendance</p> <p>(1) 未上 (2) 半日 (3) 全日 (4) 寄宿 Never Half day Full day Boarding</p>	<input type="checkbox"/>
<p>19. 幼兒在家的看護人 The child's caregiver at home</p> <p>(1) 父母 (2) 家中長輩 (3) 保姆(工人) (4) 其他 Parents Senior family members Babysitters (domestic helpers) Others</p>	<input type="checkbox"/>
<p>20. 幼兒有沒有每天刷牙習慣 Does your child brush teeth every day?</p> <p>(1) 有 (2) 無 Yes No</p>	<input type="checkbox"/>
<p>21. 幼兒除刷牙外，有沒有每天使用牙線 Does your child use dental floss in addition to tooth-brushing every day?</p> <p>(1) 有 (2) 無 Yes No</p>	<input type="checkbox"/>
<p>22. 幼兒過去12個月有沒有到牙醫診所進行牙科檢查 Did your child go to a dental clinic for dental examination within the past 12 months?</p> <p>(1) 有 (2) 無 Yes No</p>	<input type="checkbox"/>
<p>23. 幼兒是否有齲齒（選擇“無”或“不知道”者請直接回答問題第25題） Does your child have any decayed tooth? (If the answer is “no” or “don't know”, skip to Question 25)</p> <p>(1) 有 (2) 無 (3) 不知道 Yes No Don't know</p>	<input type="checkbox"/>
<p>24. 幼兒如有齲齒，有沒有到牙醫診所進行治療？ If yes, has your child visited a dental clinic for treatment?</p> <p>(1) 有 (2) 無 Yes No</p>	<input type="checkbox"/>
<p>25. 幼兒是否與父母住在一起共同生活？ Does your child live with his/her parents?</p> <p>(1) 是 (2) 否 (3) 只與父或母任一方同住 Yes No Lives with one of his/her parents</p>	<input type="checkbox"/>

2020年澳門市民體質監測數據登錄冊

Data Registration Manual of
2020 Physical Fitness Study of Macao SAR Residents

(二) 幼兒父親資料 Paternal Personal Information

1. 出生日期 Date of birth	<input type="text"/> <input type="text"/> <input type="text"/> <input type="text"/> 年 <input type="text"/> <input type="text"/> 月 <input type="text"/> <input type="text"/> 日
2. 出生地 Place of birth	<input type="text"/>
(1) 中國大陸 Mainland China	(2) 澳門 Macao
(3) 香港 Hong Kong	(4) 葡萄牙 Portugal
(5) 其他 Others	
3. 居住在澳門的年限 (年) (指連續在澳門居住的年限, 如果離開澳門的時間超過1年, 則要由回澳門居住起重新計算居澳年限) Years of residence in Macao (It refers to years of continuous residence in Macao. If he had left Macao for over 1 year, years of residence in Macao should be recalculated from the time of returning to Macao.)	<input type="text"/> <input type="text"/>
4. 身高 (cm) Height (cm)	<input type="text"/> <input type="text"/> <input type="text"/> . <input type="text"/>
5. 體重 (kg) Weight (kg)	<input type="text"/> <input type="text"/> <input type="text"/> . <input type="text"/>
6. 學歷 Education level	<input type="text"/>
(1) 小學程度以下 Below primary school education	(2) 小學 Primary school
(3) 中學 Secondary school	
(4) 專上教育 Post-secondary education	(5) 碩士 Master
(6) 博士 Doctoral	
7. 目前主要從事的職業 Current occupation	<input type="text"/>
(1) 立法機關成員、公共行政高級官員、社團領導人員及經理 Legislative officer, public administration officer, community leader or manager	
(2) 專業人員 (各學科領域之專業工作者, 也包括高等教育及中學教學人員) Professional (professionals in various disciplines including higher education and secondary school teaching staff)	
(3) 技術員及輔助專業人員 (各學科領域中主要從事技術操作工作, 也包括幼教、小學及特殊教育教師) Technician or professional assistant (persons who engaged in technical works in various disciplines including preschool, primary school and special education teachers)	
(4) 文員 (包括秘書、文書工作文員、出納員、接待員、票務員及同類工作人員) Office clerk (secretaries, secretarial work office clerks, cashiers, receptionists, ticket agents and workers of similar nature)	

幼兒(3~6歲)
Young Children (aged 3-6)

<p>(5) 服務、銷售及同類工作人員（如從事旅遊、餐飲、美容、保險等服務之工作人員、也包括消防員、交通及治安警察人員、保安員、售貨人員等） Customer service, sales representative or similar nature (persons who engaged in tourism, catering, beauty care, insurance, and also including firefighters, traffic and public security police officers, security staff, sales personnel etc.)</p> <p>(6) 漁農業熟練工作者（如漁民、農夫、儲藏及銷售漁農業及畜牧業產品等人員） Skilled worker in the fishery or agricultural field (fisher folks, farmers, and persons who engaged in storing and selling of fishery, agricultural, and livestock products etc.)</p> <p>(7) 工業工匠及手工藝工人（包括建築工人及手工業製作工人） Artisan or craftsman (including construction workers and handicraft workers)</p> <p>(8) 機台、機器操作員、司機及裝配員 Machine operator, driver or assembler</p> <p>(9) 非技術工人（如清潔員、管理員、信差、搬運工人） Non-technician (e.g. cleaners, property management officers, postpersons, porters)</p> <p>(10) 其他 Others</p> <p>(11) 待業 Unemployed</p> <p>(12) 家庭主夫 househusband</p>
--

(三) 幼兒母親資料 Maternal Personal Information

<p>1. 出生日期 Date of birth</p> <table style="width: 100%; border: none;"> <tr> <td style="border: 1px solid black; width: 20px; height: 20px;"></td> <td style="border: 1px solid black; width: 20px; height: 20px;"></td> <td style="border: 1px solid black; width: 20px; height: 20px;"></td> <td style="border: 1px solid black; width: 20px; height: 20px;"></td> <td style="padding: 0 5px;">年 Y</td> <td style="border: 1px solid black; width: 20px; height: 20px;"></td> <td style="border: 1px solid black; width: 20px; height: 20px;"></td> <td style="padding: 0 5px;">月 M</td> <td style="border: 1px solid black; width: 20px; height: 20px;"></td> <td style="border: 1px solid black; width: 20px; height: 20px;"></td> <td style="padding: 0 5px;">日 D</td> </tr> </table>					年 Y			月 M			日 D
				年 Y			月 M			日 D	
<p>2. 出生地 Place of birth</p> <table style="width: 100%; border: none;"> <tr> <td style="width: 20%; text-align: center;">(1) 中國大陸 Mainland China</td> <td style="width: 20%; text-align: center;">(2) 澳門 Macao</td> <td style="width: 20%; text-align: center;">(3) 香港 Hong Kong</td> <td style="width: 20%; text-align: center;">(4) 葡萄牙 Portugal</td> <td style="width: 20%; text-align: center;">(5) 其他 Others</td> </tr> </table>	(1) 中國大陸 Mainland China	(2) 澳門 Macao	(3) 香港 Hong Kong	(4) 葡萄牙 Portugal	(5) 其他 Others						
(1) 中國大陸 Mainland China	(2) 澳門 Macao	(3) 香港 Hong Kong	(4) 葡萄牙 Portugal	(5) 其他 Others							
<p>3. 居住在澳門的年限（年）（指連續在澳門居住的年限，如果離開澳門的時間超過1年，則要由回澳門居住起重新計算居澳年限） Years of residence in Macao (It refers to years of continuous residence in Macao. If she had left Macao for over 1 year, years of residence in Macao should be recalculated from the time of returning to Macao.)</p> <table style="width: 100%; border: none;"> <tr> <td style="border: 1px solid black; width: 40px; height: 20px;"></td> <td style="border: 1px solid black; width: 40px; height: 20px;"></td> </tr> </table>											
<p>4. 身高（cm） Height (cm)</p> <table style="width: 100%; border: none;"> <tr> <td style="border: 1px solid black; width: 20px; height: 20px;"></td> <td style="border: 1px solid black; width: 20px; height: 20px;"></td> <td style="border: 1px solid black; width: 20px; height: 20px;"></td> <td style="border: 1px solid black; width: 20px; height: 20px;"></td> <td style="padding: 0 5px;">.</td> <td style="border: 1px solid black; width: 20px; height: 20px;"></td> </tr> </table>					.						
				.							
<p>5. 體重（kg） Weight (kg)</p> <table style="width: 100%; border: none;"> <tr> <td style="border: 1px solid black; width: 20px; height: 20px;"></td> <td style="border: 1px solid black; width: 20px; height: 20px;"></td> <td style="border: 1px solid black; width: 20px; height: 20px;"></td> <td style="border: 1px solid black; width: 20px; height: 20px;"></td> <td style="padding: 0 5px;">.</td> <td style="border: 1px solid black; width: 20px; height: 20px;"></td> </tr> </table>					.						
				.							

2020年澳門市民體質監測數據登錄冊

Data Registration Manual of
2020 Physical Fitness Study of Macao SAR Residents

6. 學歷 Education level	<input type="checkbox"/>
(1) 小學程度以下 Below primary school education	(2) 小學 Primary school level
(3) 中學 Secondary school	
(4) 專上教育 Post-secondary education	(5) 碩士 Master
	(6) 博士 Doctoral
7. 目前主要從事的職業 Current occupation	<input type="checkbox"/>
(1) 立法機關成員、公共行政高級官員、社團領導人員及經理 Legislative officer, public administration officer, community leader or manager	
(2) 專業人員（各學科領域之專業工作者，也包括高等教育及中學教學人員） Professional (professionals in various disciplines including higher education and secondary school teaching staff)	
(3) 技術員及輔助專業人員（各學科領域中主要從事技術操作工作，也包括幼教、小學及特殊教育教師） Technician or professional assistant (persons who engaged in technical works in various disciplines including preschool, primary school and special education teachers)	
(4) 文員（包括秘書、文書工作文員、出納員、接待員、票務員及同類工作人員） Office clerk (secretaries, secretarial work office clerks, cashiers, receptionists, ticket agents and workers of similar nature)	
(5) 服務、銷售及同類工作人員（如從事旅遊、餐飲、美容、保險等服務之工作人員、也包括消防員、交通及治安警察人員、保安員、售貨人員等） Customer service, sales representative or similar nature (persons who engaged in tourism, catering, beauty care, insurance, and also including firefighters, traffic and public security police officers, security staff, sales personnel etc.)	
(6) 漁農業熟練工作者（如漁民、農夫、儲藏及銷售漁農業及畜牧業產品等人員） Skilled worker in the fishery or agricultural field (fisher folks, farmers, and persons who engaged in storing and selling of fishery, agricultural, and livestock products etc.)	
(7) 工業工匠及手工藝工人（包括建築工人及手工業製作工人） Artisan or craftsperson (including construction workers and handicraft workers)	
(8) 機台、機器操作員、司機及裝配員 Machine operator, driver or assembler	
(9) 非技術工人（如清潔員、管理員、信差、搬運工人） Non-technician (e.g. cleaners, property management officers, postpersons, porters)	
(10) 其他 Others	
(11) 待業 Unemployed	
(12) 家庭主婦 Housewife	

幼兒(3~6歲)
Young Children (aged 3-6)

二. 幼兒本人健身素養狀況 (由幼兒家長填寫)

Fitness Literacy of Young Child (to be filled in by parents)

填寫方法：

填寫選擇題時請在對應的數字上畫圈“○”，如選項為數字5，則圈選數字⑤。若想修改答案，請在原答案上劃斜線，如“~~5~~”，然後再寫新答案或劃“○”。

Instructions for filling:

When doing choice questions, please circle the corresponding number with “○”, e.g. if the choice is Number 5, circle Number ⑤. If you want to change your answer, cross the original answer with a slash, e.g. “~~5~~”, and then write the new answer or circle its corresponding number with “○”.

A-態度和技能 Attitude and skill

A1. 【單選題】 以下說法，請您根據您對孩子的瞭解進行選擇，在對應的數字上畫“○”。

【Single choice question】 Please choose the following descriptions according to your understanding of your child, and circle each corresponding number with “○”.

題目 Question	非常符合 Very consistent	比較符合 Slightly consistent	一般 Neutral	不太符合 Not quite consistent	非常不符合 Very inconsistent
1) 比較喜歡外出活動 My child prefers outdoor activities.	5	4	3	2	1
2) 跟您家孩子一起玩耍的小夥伴比較少(除了幼稚園之外的) My child has few friends to play with (except those in kindergarten).	5	4	3	2	1
3) 喜歡跟比自己歲數大的孩子一起玩耍 My child likes to play with older children.	5	4	3	2	1
4) 喜歡參與團隊活動 My child likes to participate in team activities.	5	4	3	2	1

2020年澳門市民體質監測數據登錄冊

Data Registration Manual of
2020 Physical Fitness Study of Macao SAR Residents

A2. 【多選題】您認為您家孩子經常進行的活動鍛煉有哪些？本題為多選題，可選1個或1個以上的答案，請圈選所有孩子經常進行的活動鍛煉，在選項對應的序號上畫“○”。

【Multiple choice question】What kind of physical exercises does your child frequently participate? This is a multiple choice question. You need to choose at least 1 option. Choose all the physical exercises in which your child frequently participated, and circle each corresponding number with “○”.

1 步行 Walking	10 羽毛球 Badminton	19 騎自行車 Cycling
2 跑步 Running	11 高爾夫球 Golf	20 游泳 Swimming
3 體操 Gymnastics	12 棒球 Baseball	21 跳繩 Rope skipping
4 舞蹈類 Dancing	13 跆拳道 Taekwondo	22 踢毽子 Shuttlecock kicking
5 籃球 Basketball	14 空手道 Karate	23 輪滑 Roller skating
6 排球 Volleyball	15 柔道 Judo	24 其他 Others
7 足球 Football	16 武術 Martial arts	25 室內外體育遊戲 Indoor and outdoor sports games
8 網球 Tennis	17 滑冰 Skating	26 沒有參與過任何活動鍛煉 (不用回答第A3題) None (skip Question A3)
9 乒乓球 Table tennis	18 滑雪 Skiing	

A3. 【多選題】您認為您家孩子擅長的活動鍛煉有哪些？本題為多選題，可選1個或1個以上的答案，請圈選所有孩子擅長的活動鍛煉，在選項對應的序號上畫“○”。

【Multiple choice question】What kind of physical exercises is your child good at? This is a multiple choice question. You need to choose at least 1 option. Choose all the physical exercises your child is good at, and circle each corresponding number with “○”.

1 步行 Walking	10 羽毛球 Badminton	19 騎自行車 Cycling
2 跑步 Running	11 高爾夫球 Golf	20 游泳 Swimming
3 體操 Gymnastics	12 棒球 Baseball	21 跳繩 Rope skipping
4 舞蹈類 Dancing	13 跆拳道 Taekwondo	22 踢毽子 Shuttlecock kicking
5 籃球 Basketball	14 空手道 Karate	23 輪滑 Roller skating
6 排球 Volleyball	15 柔道 Judo	24 其他 Others
7 足球 Football	16 武術 Martial arts	25 室內外體育遊戲 Indoor and outdoor sports games
8 網球 Tennis	17 滑冰 Skating	26 沒有擅長的活動鍛煉 None
9 乒乓球 Table tennis	18 滑雪 Skiing	

幼兒(3~6歲)
Young Children (aged 3~6)

B-運動習慣(請您選擇合適的選項，在對應的序號上畫“○”。)

Exercise habits (choose the proper answer and circle its corresponding number with “○”.)

B1. 【單選題】在上學日(週一至週五)期間，您家孩子平均每天進行體育活動的時間(包括課外到公園玩耍，在學校、托管中心或在家中鍛煉等等體育活動的時間)？

【Single choice question】On school days (Monday through Friday), what is the average time your child spends on physical exercises per day (including out-of-school time playing in the park, and exercising at school, care center, or home)?

1	沒有 None	4	60~119分鐘 60~119 minutes
2	不足30分鐘 Less than 30 minutes	5	120~179分鐘 120~179 minutes
3	30~59分鐘 30~59 minutes	6	180分鐘或以上 180 minutes or more

B2. 【單選題】在休息日(週六、週日或節假日)期間，您家孩子平均每天進行體育活動的時間(包括去公園玩耍、參加課外興趣班或家中鍛煉等等體育活動的時間)？

【Single choice question】On rest days (Saturdays, Sundays, or holidays), what is the average time your child spends on physical exercises per day (including time playing in the park, attending extracurricular hobby classes, or exercising at home)?

1	沒有 None	4	60~119分鐘 60~119 minutes
2	不足30分鐘 Less than 30 minutes	5	120~179分鐘 120~179 minutes
3	30~59分鐘 30~59 minutes	6	180分鐘或以上 180 minutes or more

B3. 【單選題】孩子有報名以體育活動為主的各種培訓班嗎(比如舞蹈班、足球班屬於以體育活動為主的培訓班，而書法班、鋼琴班等則不屬於)？

【Single choice question】Has your child signed up for any training classes chiefly related to physical exercise (e.g. dancing class and football class are training classes related to physical exercise, whereas calligraphy class and piano class are not)?

1	從不報名(不用回答B4題) Never (skip Question B4)
2	偶爾會報名一些類似的培訓班 Sometimes will participate in similar training classes
3	有詳細的計劃，一直堅持報名類似的培訓班 Has been consistently participating in similar training classes with a detailed plan

2020年澳門市民體質監測數據登錄冊

Data Registration Manual of
2020 Physical Fitness Study of Macao SAR Residents

B4. 【單選題】您家孩子參加B3中提及的培訓班，每週平均多長時間？

【Single choice question】What is the average time your child spends on the training class(es) mentioned in Question B3 in a typical week?

1	現在暫時沒有 Currently none	4	90-119分鐘 90~119 minutes
2	不足60分鐘 Less than 60 minutes	5	120~179分鐘 120~179 minutes
3	60-89分鐘 60~89 minutes	6	180分鐘或以上 180 minutes or more

B5. 【單選題】在上學日(週一至週五)，您家孩子通常平均每天有多長時間花在看電視、使用手機/電腦/平板電腦等電子產品上？

【Single choice question】On school days (Monday through Friday), what is the average daily time your child spends on watching TV and using electronic devices such as mobile/computers/laptop computers?

1	1~29分鐘 1~29 minutes	6	3個小時~不足4個小時 3 hours ~ less than 4 hours
2	30~59分鐘 30~59 minutes	7	4個小時~不足5個小時 4 hours ~ less than 5 hours
3	60分鐘-89分鐘 60~89 minutes	8	5個小時~不足6個小時 5 hours ~ less than 6 hours
4	90~119分鐘 90~119 minutes	9	6個小時或以上 6 hours or more
5	2個小時~不足3個小時 2 hours ~ less than 3 hours	10	一般沒有 Basically none

B6. 【單選題】在休息日(週六、週日或節假日)，您家孩子通常平均每天有多長時間花在看電視、使用手機/電腦/平板電腦等電子產品上？

【Single choice question】On rest days (Saturdays, Sundays, or holidays), what is the average daily time your child spends on watching TV and using electronic devices such as mobile/computers/laptop computers?

1	1~29分鐘 1~29 minutes	6	3個小時~不足4個小時 3 hours ~ less than 4 hours
2	30~59分鐘 30~59 minutes	7	4個小時~不足5個小時 4 hours ~ less than 5 hours
3	60分鐘-89分鐘 60~89 minutes	8	5個小時~不足6個小時 5 hours ~ less than 6 hours
4	90~119分鐘 90~119 minutes	9	6個小時或以上 6 hours or more
5	2個小時~不足3個小時 2 hours ~ less than 3 hours	10	一般沒有 Basically none

幼兒(3~6歲)
Young Children (aged 3~6)

B7. 【單選題】在上學日(週一至週五)，您家孩子午間睡眠的平均時長？

【Single choice question】 On school days (Monday through Friday), what is the average nap time of your child?

1	不足1小時 Less than 1 hour	5	4小時 4 hours
2	1小時 1 hour	6	4小時以上 4 hours or more
3	2小時 2 hours	7	不睡午覺 No nap
4	3小時 3 hours		

B8. 【單選題】在上學日(週一至週五)，您家孩子夜間睡眠的平均時長？

【Single choice question】 On school days (Monday through Friday), what is the average sleep time of your child at night?

1	不足7小時 Less than 7 hours	5	11小時 11 hours
2	8小時 8 hours	6	12小時 12 hours
3	9小時 9 hours	7	13小時 13 hours
4	10小時 10 hours	8	13小時以上 13 hours or more

B9. 【單選題】在休息日(週六、週日或節假日)，您家孩子午間睡眠的平均時長？

【Single choice question】 On rest days (Saturdays, Sundays, or holidays), what is the average nap time of your child?

1	不足1小時 Less than 1 hour	5	4小時 4 hours
2	1小時 1 hour	6	4小時以上 4 hours or more
3	2小時 2 hours	7	不睡午覺 No nap
4	3小時 3 hours		

B10. 【單選題】在休息日(週六、週日或節假日)，您家孩子夜間睡眠的平均時長？

【Single choice question】 On rest days (Saturdays, Sundays, or holidays), what is the average sleep time of your child at night?

1	不足7小時 Less than 7 hours	5	11小時 11 hours
2	8小時 8 hours	6	12小時 12 hours
3	9小時 9 hours	7	13小時 13 hours
4	10小時 10 hours	8	13小時以上 13 hours or more

2020年澳門市民體質監測數據登錄冊

Data Registration Manual of
2020 Physical Fitness Study of Macao SAR Residents

C-自身特質和家庭環境(請您選擇合適的選項，在對應的序號上畫“○”。)
Personal traits and home environment (choose the proper answer and circle its corresponding number with “○”.)

C1. 【單選題】以下說法，請您根據您對孩子的瞭解進行選擇，在對應的數字上畫“○”。

【Single choice question】 Please choose from the following descriptions according to your understanding of your child. Circle each corresponding number with “○”.

題目 Question	非常符合 Very consistent	比較符合 Slightly consistent	一般 Neutral	不太符合 Not quite consistent	非常不符合 Very inconsistent
1) 比較好動 My child is physically active.	5	4	3	2	1
2) 喜歡做相對安靜的事情 My child likes activities that are relatively quiet.	5	4	3	2	1
3) 與別人相處比較謹慎 My child is cautious with others.	5	4	3	2	1
4) 比較喜歡獨處 My child prefers staying alone	5	4	3	2	1

C2. 【單選題】與同齡人相比，您認為孩子當前的活動量是否足夠。

【Single choice question】 Do you think your child has adequate amount of exercise currently compared to peers?

1	非常缺乏 Lack of exercise	3	一般 Neutral	5	非常充足 Very sufficient
2	不太夠 Insufficient	4	比較充足 Relatively sufficient		

C3. 【單選題】與同齡人相比，您對孩子當前的活動能力如何評價。

【Single choice question】 How would you describe your child's current exercise ability compared to peers?

1	非常優秀 Excellent	3	一般 General	5	極待提高 Very poor
2	比較優秀 Good	4	有待提高 Could be improved		

幼兒(3~6歲)
Young Children (aged 3~6)

C4. 【單選題】孩子的父親進行體育鍛煉的頻率如何？

【Single choice question】 What is the exercise frequency of the child's father?

1	每週3次以上 More than 3 times per week	3	每月1-3次 1-3 times per month	5	從不進行鍛煉 Never
2	每週1-3次 1-3 times per week	4	更低頻率 Lower frequency than the above	6	不知道 Don't know

C5. 【單選題】孩子的母親進行體育鍛煉的頻率如何？

【Single choice question】 What is the exercise frequency of the child's mother?

1	每週3次以上 More than 3 times per week	3	每月1-3次 1-3 times per month	5	從不進行鍛煉 Never
2	每週1-3次 1-3 times per week	4	更低頻率 Lower frequency than the above	6	不知道 Don't know

C6. 【單選題】您願意花錢讓孩子參加體育活動嗎？

【Single choice question】 Are you willing to pay for your child to participate in physical exercise?

5	非常願意 Absolutely	3	一般 Neutral	1	非常不願意 Absolutely not
4	比較願意 Willing	2	不太願意 Unwilling		

C7. 【單選題】在休息日（週六、週日或節假日），孩子的父親平均每天對著屏幕（電視、手機、平板、遊戲機等）的時間有多長？

【Single choice question】 On rest days (Saturdays, Sundays, or holidays), what is the average daily screen time (such as TV, mobile, laptop, game console) of the child's father?

1	1~29分鐘 1-29 minutes	7	4個小時~不足5個小時 4 hours ~ less than 5 hours
2	30~59分鐘 30-59 minutes	8	5個小時~不足6個小時 5 hours ~ less than 6 hours
3	60分鐘-89分鐘 60-89 minutes	9	6個小時或以上 6 hours or more
4	90~119分鐘 90-119 minutes	10	一般沒有 Basically none
5	2個小時~不足3個小時 2 hours ~ less than 3 hours	11	不知道 Don't know.
6	3個小時~不足4個小時 3 hours ~ less than 4 hours		

2020年澳門市民體質監測數據登錄冊

Data Registration Manual of
2020 Physical Fitness Study of Macao SAR Residents

C8. 【單選題】在休息日（週六、週日或節假日），孩子的母親平均每天對著屏幕（電視、手機、平板、遊戲機等）的時間有多長？

[Single choice question] On rest days (Saturdays, Sundays, or holidays), what is the average daily screen time (such as TV, mobile, laptop, game console) of the child's mother?

1	1~29分鐘 1-29 minutes	7	4個小時~不足5個小時 4 hours ~ less than 5 hours
2	30~59分鐘 30-59 minutes	8	5個小時~不足6個小時 5 hours ~ less than 6 hours
3	60分鐘-89分鐘 60-89 minutes	9	6個小時或以上 6 hours or more
4	90~119分鐘 90-119 minutes	10	一般沒有 Basically none
5	2個小時~不足3個小時 2 hours ~ less than 3 hours	11	不知道 Don't know.
6	3個小時~不足4個小時 3 hours ~ less than 4 hours		

C9. 【多選題】請問家裏有條件提供而您家孩子又經常玩耍或使用的娛樂用品都有哪些？

本題為多選題，可選1個或1個以上的答案，如果相關用品沒有在下面列舉的選項範圍，請選擇“17、其他”。

[Multiple choice question] What kind of entertainment products does your child always play at home? This is a multiple choice question. You need to choose at least 1 option. If the options below are not suitable, choose "17. Others".

1	電視 TV	7	足球 Football	13	各種積木類玩具 Toy bricks
2	遊戲機 Game console	8	乒乓球 Table tennis	14	機器人、洋娃娃等玩具 Robot toy, doll, etc.
3	手機 Mobile	9	毽子 Shuttlecock	15	輪滑鞋、滑板 Roller skates, skateboard
4	電腦/平板電腦 Computer / laptop computer	10	籃球 Basketball	16	網球 Tennis
5	跳繩 Rope skipping	11	羽毛球 Badminton	17	其他 Others
6	兒童腳踏車/自行車 Kid's bike / bicycle	12	排球 Volleyball	18	沒有使用相關用品 None

C10. 【單選題】您對孩子的體重情況如何評價。

[Single choice question] How would you describe your child's weight?

1	非常胖 Obese	3	剛好 Healthy	5	非常瘦 Severely underweight
2	比較胖 Overweight	4	比較瘦 Underweight		

幼兒(3~6歲)
Young Children (aged 3~6)

C11. 【單選題】下面的說法是否符合實際情況。

【Single choice question】 Which of the following descriptions is accurate?

題目 Question	符合 Accurate	不符合 Inaccurate
1) 完全根據孩子的喜好來鼓勵、選擇孩子參與的體育活動 I encourage and choose physical exercises based solely on my child's preferences.	1	2
2) 針對孩子的弱項(比如性格、技能等)，有目的地鼓勵、選擇孩子參與的體育活動 I purposefully encourage and select physical exercises for my child according to his/her weaknesses (such as personality and skills)。	1	2
3) 根據您對各種體育活動特點的瞭解，為孩子選擇合適的體育活動 I choose the proper physical exercises for my child according to my understanding of various physical exercises.	1	2

C12. 【單選題】對於“您認為適合孩子的體育活動，而孩子說不喜歡”，下面的說法是否符合實際情況。

【Single choice question】 Which of the following descriptions is accurate, when “the physical exercise that you think is appropriate is dislike by your child”?

題目 Question	符合 Accurate	不符合 Inaccurate
1) 您會讓孩子停止參與 I will allow my child to quit.	1	2
2) 您會讓孩子繼續堅持一段時間再做決定 I will let my child hold on for a while before making a decision.	1	2
3) 您認為對孩子有好處，會堅持讓孩子一直參與 I will insist that my child should keep participating if I think it is good for him/her.	1	2

C13. 【單選題】在休息日(週六、週日或節假日)，父親(或)母親平均每天陪伴孩子出去玩耍的時間有多長?

【Single choice question】 On rest days (Saturdays, Sundays, or holidays), what is the daily average time the child's father or mother spent on playing outside with the child?

1	1~2小時之內 1-2 hours	5	8~12個小時之內 8-12 hours
2	2~4小時之內 2-4 hours	6	12個小時或以上 12 hours or more
3	4~6小時之內 4-6 hours	7	完全沒有時間 None at all
4	6~8小時之內 6-8 hours		

2020年澳門市民體質監測數據登錄冊

Data Registration Manual of
2020 Physical Fitness Study of Macao SAR Residents

C14. 【多選題】請問對孩子的活動（無論是室內和室外），您都會有哪些規矩和要求？

本題為多選題，可選1個或1個以上的答案。

【Multiple choice question】What kind of rules and requirements do you have for your child's activities, both indoors and outdoors? This is a multiple choice question, you need to choose at least 1 option.

1	在家裡不可以亂跑 My child is not allowed to run around in the house.	4	在室外玩耍不允許參與一些太過激烈的活動或遊戲 Vigorous activities or games are not allowed when playing outside.
2	家裡的球狀玩具不可以到處放 My child is not allowed to leave ball-shaped toys lying around in the house	5	不允許孩子追逐打鬧 My child is not allowed to chase and fight.
3	孩子須經家長同意才可以出去玩 My child is not allowed to go out to play without my consent.	6	其他規矩或要求 Other rules or requirements

C15. 【單選題】對於運動的理解和態度，下面的說法是否符合您的實際情況？

【Single choice question】According to your understanding and attitude of physical exercise, which of the following descriptions is accurate?

題目 Question	符合 Accurate	不符合 Inaccurate
1) 在運動成績、技能等各方面，我都喜歡跟人比較，享受比別人強的那種快感 As for exercise performance, skills or other aspects, I like to compete with others, and enjoy the pleasure of having better performance than others.	1	2
2) 運動中競爭獲勝的感覺實在太棒了，我認為這是最重要的 Winning is the most important part in sports competitions and it makes me feel great.	1	2
3) 通過競爭，我找到了運動存在的意義 I have found the meaning of physical exercise through competition.	1	2
4) 假設某項運動技能只有你會，其他人都不會，你會覺得非常有成就感 I feel very accomplished if I have sports skills that no one else has.	1	2
5) 通過運動我學到了很多新的東西，這個過程非常有趣 I have learned a lot of new things through physical exercise and the process is very interesting.	1	2
6) 運動中學到的新東西，我都會盡量多加練習 I will try my best to practice the new things I have learned in sports activities.	1	2

幼兒(3~6歲)
Young Children (aged 3~6)

D-社區環境(請您選擇合適的選項，在對應的序號上畫“○”。)
Community environment (choose the proper answer and circle its corresponding number with “○”.)

D1. 【單選題】請問去離您住所最近的公園或商場等休閒活動類場所是否方便？

【Single choice question】Is it convenient for you to go to recreational facilities such as park, shopping mall nearest to your home?

1	非常不方便 Very inconvenient	3	一般 Neutral	5	非常方便 Very convenient
2	不太方便 Inconvenient	4	比較方便 Convenient		

D2. 【單選題】請問在您住所的周邊，孩子玩耍、活動是否安全？

【Single choice question】Is it safe for children to play or do physical exercises around your residence?

5	非常安全 Very safe	3	一般 Average	1	很不安全 Very unsafe
4	比較安全 Relatively safe	2	不太安全 Unsafe		

D3. 【單選題】請問您對住所周邊的環境（比如綠化、衛生情況）的總體評價如何。

【Single choice question】How would you rate your residential environment (such as greening and sanitation)?

5	非常滿意 Extremely satisfied	3	一般 Neutral	1	非常不滿意 Extremely dissatisfied
4	比較滿意 Satisfied	2	不太滿意 Dissatisfied		

2020年澳門市民體質監測數據登錄冊

Data Registration Manual of
2020 Physical Fitness Study of Macao SAR Residents

D4. 【多選題】您認為制約孩子外出活動的最主要3個住所及周邊的環境因素是甚麼？請您在下列選項中選擇您認為最重要的3個選項，在對應的序號上畫“○”。

【Multiple choice question】What are the 3 main residential environmental factors that limit your child's outdoor activities in your opinion? Choose the top 3 factors, and circle each corresponding number with “○”.

1	交通不便 Inconvenient transportation	7	社區宣傳不夠 Insufficient community publicity
2	缺乏合適的場地 Lack of suitable venues	8	社區缺乏可參與的活動 Lack of suitable activities in community
3	寵物多 Too many pets	9	人口過於稠密，人均資源佔有率太低 The per capita resource occupancy is too low due to dense population.
4	環境衛生差 Poor environmental hygiene	10	治安不夠好 Not secure enough
5	社區進出閒雜人員太多 Too many visitors in community	11	其他 Others
6	缺乏適合孩子的玩樂設施和器材 Lack of recreational facilities suitable for children		

此問卷的填寫人是孩子的 This questionnaire is filled out by the _____ of the child.

1	父親 Father	2	母親 Mother	3	爺爺奶奶或外公外婆 Grandpa/grandma	4	其他人 Others
---	--------------	---	--------------	---	------------------------------	---	---------------

問卷完畢。謝謝。

This is the end of the questionnaire.
Thank you for participating.

幼兒(3~6歲)
Young Children (aged 3-6)

三. 檢測指標 (由監測人員在監測現場填寫)

Testing indicators (to be filled in by examiner on site)

1. 身高 (cm) Height (cm)	<input type="text"/> <input type="text"/> <input type="text"/> . <input type="text"/>
2. 坐高 (cm) Sitting height (cm)	<input type="text"/> <input type="text"/> . <input type="text"/>
3. 體重 (kg) Weight (kg)	<input type="text"/> <input type="text"/> <input type="text"/> . <input type="text"/>
4. 胸圍 (cm) Chest circumference (cm)	<input type="text"/> <input type="text"/> . <input type="text"/>
5. 腰圍 (cm) Waist circumference (cm)	<input type="text"/> <input type="text"/> . <input type="text"/>
6. 臀圍 (cm) Hip circumference (cm)	<input type="text"/> <input type="text"/> . <input type="text"/>
7. 體脂率 (%) Body fat percentage (%)	<input type="text"/> <input type="text"/> . <input type="text"/>
8. 肩寬 (cm) Shoulder width (cm)	<input type="text"/> <input type="text"/> . <input type="text"/>
9. 骨盆寬 (cm) Pelvis width (cm)	<input type="text"/> <input type="text"/> . <input type="text"/>
10. 足長 (cm) Foot length (cm)	<input type="text"/> <input type="text"/> . <input type="text"/>
11. 安靜心率 (次/分) Resting heart rate (bpm)	<input type="text"/> <input type="text"/> <input type="text"/>
12. 坐位體前屈 (cm) Sit and reach (cm)	<input type="text"/> <input type="text"/> <input type="text"/> . <input type="text"/>
13. 10米折返跑 (秒) 10m shuttle run (sec)	<input type="text"/> <input type="text"/> . <input type="text"/>

II. Children and Adolescents (Students)

1. Primary Students (Primary 1~3)

2020

澳門市民體質監測
Physical Fitness Study of Macao SAR Residents

數據登錄冊
Data Registration Manual

兒童青少年(學生：6~22歲)
Children and Adolescents
(Students aged 6~22)

(小學一年級~小學三年級學生)
(Primary 1~3)

澳門特別行政區政府體育局
Sports Bureau, Macao SAR



歡迎閣下參加2020年澳門市民體質監測！澳門市民體質監測是特區政府為推動大眾健身活動的開展而進行的調查研究。在此首先感謝閣下對監測的支持並認真、如實地填寫問卷，我們保證對閣下的個人資料保密，有關資料不會獨立出現或使用，它將是整體數據的組成部分。再次對閣下的真誠參與表示感謝！

如對調查內容和檢測項目有任何疑問，歡迎向體育局運動醫學中心垂詢！

電話：28810896，88934540

Thank you for participating in our 2020 Physical Fitness Study! This study is organized by the Macao SAR Government to promote Sports for All. We are grateful for your participation. Your honesty and sincerity in filling out the questionnaire are appreciated. We promise to keep your personal data confidential and we will not publish or use your data individually. It will only be used as part of the whole study for statistical purposes. Again, we would like to extend our most sincere gratitude for your participation!

For any enquiries regarding the questionnaire or testing items, please feel free to contact Sports Medicine Centre of Macao Sports Bureau!
Telephone: 28810896, 88934540

2020年澳門市民體質監測數據登錄冊

Data Registration Manual of
2020 Physical Fitness Study of Macao SAR Residents體育局轄下運動醫學中心預先聲明
Declaration
Sports Medicine Centre of Macao Sports Bureau

本聲明旨在向個人資料當事人或相關家長或監護人確保遵守第8/2005號法律“個人資料保護法”所規範的事宜。

This declaration is intended to assure data subjects or their parents or guardians that we will strictly comply with the relevant provisions of Act 8/2005 - Personal Data Protection Act.

1. 處理個人資料的負責人—體育局，地址設於澳門羅理基博士大馬路818號。代表—體育局局長。

Personal data controller: Macao Sports Bureau, at Av. Dr. Rodrigo Rodrigues, n.º 818, Macao.
Representative - President of Macao Sports Bureau.

2. 處理個人資料的目的—進行澳門市民體質監測，以便為制定日後關於體育及醫療護理的政策提供科學數據。收集的數據旨在更新僅為統計用途的數據庫。

Purposes of processing personal data: To conduct the physical fitness study for Macao residents, and provide scientific references for the development of relevant policies regarding sports and medical care. Data collected through the physical fitness study will only be used to update the database for statistical purposes.

3. 個人資料當事人類別—參與是次計劃的澳門居民（隨年齡抽樣）。

Categories of subjects with personal data: Macao residents participated in the study (random sampling by age).

4. 個人資料接收者—個人資料當事人（或相關家長或監護人），運動醫學中心及國家體育總局體育科學研究所。

Personal data recipients: Data subjects (or their parents or guardians), Sports Medicine Centre and China Institute of Sport Science.

5. 接收及處理個人資料的條件—個人資料當事人（或相關家長或監護人）享有第8/2005號法律賦予的所有權利如查閱權及更正所收集的個人資料。運動醫學中心承諾對不正確的數據進行更正，刪除或封鎖。

Conditions of receiving and processing personal data: Data subjects (or their parents or guardians) are entitled by Act 8/2005 - Personal Data Protection Act to the rights to access and rectify their own personal data collected. The Sports Medicine Centre hereby commits to take proper measures to rectify, delete or block any incorrect data.

兒童青少年（學生：6~22歲）- 小學一年級~小學三年級學生
Children and Adolescents (Students aged 6~22) - (Primary 1~3)

6.處理個人資料的安全和保密性—對處理及編輯個人資料絕對保密及採取適當措施以確保其安全。

Security and confidentiality of processing personal data: Appropriate measures are implemented to process and edit the personal data to ensure strict confidentiality, safety and security of the data.

本人已明白上述內容權益

I, the undersigned, am aware of the contents and my legal rights in the above declaration.

(個人資料當事人或家長或監護人簽名)
(Signature of subject providing personal
data/parents/guardian)

_____/_____/_____
(日) (月) (年)
(DD) (MM) (YY)

姓 名 :	_____
Name:	_____
性 別 :	_____
Gender:	_____
年 齡 :	_____ (周歲)
Age:	_____ (years)
就讀學校 :	_____
School:	_____
聯繫電話 :	_____
Phone:	_____

2020年澳門市民體質監測數據登錄冊

Data Registration Manual of
2020 Physical Fitness Study of Macao SAR Residents

一.分類編碼（學生個人資料，小學生可由家長協助填寫）

General Information (Personal information of primary student can be filled in by the parents)

填寫方法：

填寫選擇題時請將選擇答案的序號填入相應的方格中，如選答案（1），則在方格內填1；序號為兩位數時，兩位數字填入同一方格，如選項為（11），則將 填入同一方格，即填為 。在填寫多項選擇題時，如果僅選擇一個或兩個答案，則應在剩餘方格內填0。

Instructions for filling:

Please fill in the boxes with the corresponding numbers. For example, if the chosen answer is (1), fill in the box with "1". If the chosen option is a two digit number, write both digits in the same box. e.g. If the chosen option is (11), fill in the box with . For multiple choice questions, if only one or two option(s) were chosen, please fill in the remaining blank box(es) with "0".

1.澳門居民身份證號碼 Macao ID card number	<input type="text"/> <input type="text"/> <input type="text"/> <input type="text"/> <input type="text"/> <input type="text"/> <input type="text"/> <input type="text"/>		
2.性別 Gender	(1) 男 Male	(2) 女 Female	<input type="text"/>
3.出生日期 Date of birth	<input type="text"/> <input type="text"/> <input type="text"/> <input type="text"/> 年 Y	<input type="text"/> <input type="text"/> 月 M	<input type="text"/> <input type="text"/> 日 D
4.測試日期（由監測人員填寫） Examination date (to be filled in by examiner)	<input type="text"/> <input type="text"/> <input type="text"/> <input type="text"/> 年 Y	<input type="text"/> <input type="text"/> 月 M	<input type="text"/> <input type="text"/> 日 D
5.學校代碼（由監測人員填寫） School code number (filled in by examiner)	<input type="text"/> <input type="text"/> <input type="text"/> <input type="text"/>		
6.測試序號（由監測人員填寫） Serial number (filled in by examiner)	<input type="text"/> <input type="text"/> <input type="text"/> <input type="text"/>		
7.居住在澳門的年限（年）（指連續在澳門居住的年限，如果離開澳門的時間超過1年，則要由回澳門居住起重新計算居澳年限） Years of residence in Macao (It refers to years of continuous residence in Macao. If you had left Macao for over 1 year, years of residence in Macao should be recalculated from the time of returning to Macao.)	<input type="text"/> <input type="text"/>		

兒童青少年（學生：6~22歲）- 小學一年級~小學三年級學生
Children and Adolescents (Students aged 6~22) - (Primary 1~3)

8. 在學校就讀年級 School grade	<input type="checkbox"/>
(1) 小學一年級 Primary 1	(2) 小學二年級 Primary 2
	(3) 小學三年級 Primary 3
9. 出生地 Place of birth	<input type="checkbox"/>
(1) 中國大陸 Mainland China	(2) 澳門 Macao
(3) 香港 Hong Kong	(4) 葡萄牙 Portugal
	(5) 其他 Others
10. 居住地所屬堂區 Parish of residence	<input type="checkbox"/>
(1) 聖方濟各堂區（路環） Paróquia de São Francisco Xavier (Coloane)	
(2) 聖嘉模堂區（氹仔） Paróquia de Nossa Senhora do Carmo (Taipa)	
(3) 風順堂區（包括媽閣山、西望洋山、下環及內港一帶） Paróquia de S. Lourenço (Zonas das Colinas da Barra e da Penha, da Praia do Manduco e do Porto Interior)	
(4) 大堂區（新馬路一帶、南灣、水坑尾、新口岸南北地段及南灣湖發展區） Paróquia da Sé Catedral (Zonas da Almeida Ribeiro, da Praia Grande, da Rua do Campo, dos Lotes norte e sul do Porto Exterior e da Zona do Lago Nam Van)	
(5) 花王堂區（聖安多尼堂區，在澳門西部，包括高士德大馬路、新橋和沙梨頭） Paróquia de Santo António (Zonas da Freguesia de Santo António, do Oeste de Macau, incluindo Av. Horta e Costa, de San Kiu e do Patane)	
(6) 望德堂區（包括荷蘭園、松山一帶） Paróquia de S. Lázaro (Zona do Conselheiro Ferreira de Almeida e da Colina da Guia)	
(7) 花地瑪堂區（俗稱北區，包括青洲、台山、黑沙環、筷子基和水塘） Paróquia de Nossa Senhora de Fátima (Zonas do Norte, incluindo Ilha Verde, Tamagnini Barbosa, Areia Preta, Fái Chi Kei e Reservatório)	
11. 近5年曾患過何種疾病（經醫院確診的疾病）（選擇“無”者請直接回答問題第13題） Any hospital-diagnosed diseases suffered within the past 5 years? (If the answer is “no”, skip to Question 13)	<input type="checkbox"/>
(1) 有 Yes	(2) 無 No

2020年澳門市民體質監測數據登錄冊

Data Registration Manual of
2020 Physical Fitness Study of Macao SAR Residents

12. 患病種類 (患病者按主次順序, 最多可填寫3項) Diseases suffered (in order of precedence, choose up to 3 diseases)			<input type="text"/>	<input type="text"/>	<input type="text"/>
(1) 氣管炎 Tracheitis	(2) 肺炎 Pneumonia	(3) 哮喘 Asthma			
(4) 過敏性鼻炎 Allergic rhinitis	(5) 腹瀉病 Diarrhea	(6) 腸胃炎 Gastroenteritis			
(7) 腎炎 Nephritis	(8) 扁桃腺炎 Tonsillitis	(9) 肝炎 Hepatitis			
(10) 肺結核 Tuberculosis	(11) 水痘 Varicella	(12) 脊柱彎曲異常 Scoliosis			
(13) 流行性腮腺炎 Mumps	(14) 貧血 Anemia	(15) 心臟病 Heart disease			
(16) 糖尿病 Diabetes	(17) 意外傷害(造成人體的損傷而 需要醫治或影響了正常的活動) Accidental injury (injury to the body that needs treatments, or injury that affects normal activities)	(18) 其他 Others			
13. 有沒有每天刷牙習慣 Do you brush your teeth every day?			<input type="checkbox"/>		
(1) 有 Yes	(2) 無 No				
14. 除刷牙外, 有沒有每天使用牙線 Do you use dental floss in addition to tooth-brushing every day?			<input type="checkbox"/>		
(1) 有 Yes	(2) 無 No				
15. 過去12個月有沒有到牙醫診所進行牙科檢查 Did you go to a dental clinic for dental examination within the past 12 months?			<input type="checkbox"/>		
(1) 有 Yes	(2) 無 No				
16. 是否有齲齒 (選擇“無”或“不知道”者請直接回答問題第18題) Do you have any decayed tooth? (If the answer is “no” or “don’t know”, skip to Question 18)			<input type="checkbox"/>		
(1) 有 Yes	(2) 無 No	(3) 不知道 Don't know			
17. 如有齲齒, 有沒有到牙醫診所進行治療? If yes, have you visited a dental clinic for treatment?			<input type="checkbox"/>		
(1) 有 Yes	(2) 無 No				

兒童青少年（學生：6~22歲）- 小學一年級~小學三年級學生
Children and Adolescents (Students aged 6~22) - (Primary 1~3)

18. 是否有親兄弟姐妹? Do you have any siblings?	<input type="checkbox"/>	
(1) 沒有 No	(2) 有1個 1	(3) 有2個或以上 2 or more
19. 是否有影響開展體育活動的先天性疾病或者殘疾? Do you have any congenital disease or disability that affects physical activity?	<input type="checkbox"/>	
(1) 沒有 No	(2) 有 (請注明 Yes (Please specify _____))	
20. 是否與父母住在一起共同生活? Do you live with your parents?	<input type="checkbox"/>	
(1) 是 Yes	(2) 否 No	(3) 只與父或母任一方同住 Live with one of my parents

2020年澳門市民體質監測數據登錄冊

Data Registration Manual of
2020 Physical Fitness Study of Macao SAR Residents

二. 健身素養問卷 Fitness Literacy

填寫方法：

填寫選擇題時請在對應的數字上畫圈“○”，如選項為數字5，則圈選數字⑤。若想修改答案，請在原答案上劃斜線，如“~~⑤~~”，然後再寫新答案或劃“○”。填寫填空題時請在“”上填寫數字或文字；如填寫“跑步”，則在“”上填寫“”。

Instructions for filling:

When doing choice questions, please circle the corresponding number with “○”. E.g. if the choice is Number 5, circle Number ⑤. If you want to change your answer, cross the original answer with a slash, i.e. “~~⑤~~”, and then write the new answer or circle its corresponding number with “○”. For blank-filling questions, fill in the blanks “” with the answers (numbers or words). E.g. if the answer is “running”, write “running” in the blank.

第一部份 孩子獨立回答部份

Part 1 Questions to be answered by child independently

【家長協助孩子填寫時要根據孩子回答的情況進行圈選，在對應的序號上畫“○”。】

[When assisting your child with these questions, please fill in according to your child's answers, and circle each corresponding number with “○”.]

1. 【單選題】你(孩子)認為以下說法是否正確？

【Single choice question】Which of the following descriptions do you (child) think are correct?

題目 Question	正確 Correct	錯誤 Incorrect	不知道 Don't know
1) 吃完飯後要休息一會兒才可以運動 Take a rest after meal before exercising.	1	2	3
2) 運動之前要適當的做一下準備活動 Warm up properly before exercising.	1	2	3
3) 運動時抽筋，應該休息 Take a rest when there is muscle cramp during exercising.	1	2	3
4) 進行體育鍛煉，運動前應該換上運動鞋 Put on sports shoes before exercising.	1	2	3

兒童青少年（學生：6~22歲）- 小學一年級~小學三年級學生
Children and Adolescents (Students aged 6~22) - (Primary 1~3)

2. 【單選題】請問你(孩子)喜不喜歡體育活動?

【Single choice question】Do you (child) like physical exercise?

1	非常喜歡 Extremely like	3	既不喜歡也不討厭 Neutral	5	很討厭 Strongly dislike
2	喜歡 Like	4	不喜歡 Dislike		

3. 【單選題】你(孩子)給自己在學校體育課上的表現打個分數，從0到10分裏面選一個分數，最好是10分，最差是0分，你(孩子)打幾分？

【Single choice question】Please rate for your own performance in physical education (PE) class. On a scale from 0 to 10, with 10 scores for the best and 0 for the worst, how many scores will you (child) get?

0分 0	1分 1	2分 2	3分 3	4分 4	5分 5	6分 6	7分 7	8分 8	9分 9	10分 10
---------	---------	---------	---------	---------	---------	---------	---------	---------	---------	-----------

4. 【單選題】無論是在學校裏，還是跟家裏人外出，你(孩子)都很喜歡玩嗎？

【Single choice question】Do you (child) like to play no matter at school or going out with your family?

1	非常喜歡 Extremely like	3	既不喜歡也不討厭 Neutral	5	很討厭 Strongly dislike
2	喜歡 Like	4	不喜歡 Dislike		

5. 【單選題】你(孩子)覺得自己一直都是很有精神、很有活力嗎？

【Single choice question】Do you (child) think you are always energetic and physically active?

1	一直都是 Always	2	大多數時間是 Most of the time	3	很多時間不是 Usually not
---	----------------	---	----------------------------	---	-----------------------

6. 【單選題】你(孩子)認為參加體育活動可以認識很多新朋友嗎？

【Single choice question】Do you (child) think you can get to know a lot of new friends by taking part in physical exercise?

1	是的 Yes	2	不是 No	3	不知道 Don't know
---	-----------	---	----------	---	-------------------

2020年澳門市民體質監測數據登錄冊

Data Registration Manual of
2020 Physical Fitness Study of Macao SAR Residents

7. 【多選題】你(孩子)認為參加體育活動有甚麼好處? 本題為多選題，可選1個或1個以上的答案，如果孩子的回答沒在下面列舉的選項範圍中，請選擇“11、其他”。

【Multiple choice question】What do you (child) think are the benefits of taking part in physical exercise? This is a multiple choice question. You need to choose at least 1 option. If your answer is not in the options, choose “11. Others”.

1	減肥 To lose weight	7	很刺激 It's exciting.
2	長高 To grow taller	8	不會被其他人嘲笑 To avoid being ridiculed
3	會覺得比別人厲害 To perform better than others	9	學到很多東西 To be able to learn a lot
4	變得更強壯 To become stronger	10	周圍的人要求的 As required by others.
5	很快樂 To be happy	11	其他 Others
6	做得好會得到老師和同學的誇獎 To win praises from teachers and classmates.	12	不知道有甚麼好處 Don't know.

8. 【多選題】你(孩子)嘗試過的體育鍛煉項目都有哪些? 本題為多選題，可選1個或1個以上的答案，如果孩子的回答沒在下面列舉的選項範圍中，請選擇“24、其他”。

【Multiple choice question】What kind of physical exercises have you (child) tried? This is a multiple choice question. You need to choose at least 1 option. If your answer is not in the options, choose “24. Others”.

1	步行 Walking	10	羽毛球 Badminton	19	騎自行車 Cycling
2	跑步 Running	11	高爾夫球 Golf	20	游泳 Swimming
3	體操 Gymnastics	12	棒球 Baseball	21	跳繩 Rope skipping
4	舞蹈類 Dancing	13	跆拳道 Taekwondo	22	踢毽子 Shuttlecock kicking
5	籃球 Basketball	14	空手道 Karate	23	輪滑 Roller skating
6	排球 Volleyball	15	柔道 Judo	24	其他 Others
7	足球 Football	16	武術 Martial arts	25	沒有參與過任何體育鍛煉 (不用回答第9題) None (skip Question 9)
8	網球 Tennis	17	滑冰 Skating		
9	乒乓球 Table tennis	18	滑雪 Skiing		

兒童青少年（學生：6~22歲）- 小學一年級~小學三年級學生
Children and Adolescents (Students aged 6~22) - (Primary 1~3)

9. 【多選題】你(孩子)能夠掌握的體育鍛煉項目都有哪些?本題為多選題，可選1個或1個以上的答案，如果孩子的回答沒在下面列舉的選項範圍中，請選擇“24、其他”。

【Multiple choice question】What kind of physical exercises can you (child) do? This is a multiple choice question, you need to choose at least 1 option. If your answer is not in the options, choose “24. Others”.

1 步行 Walking	10 羽毛球 Badminton	19 騎自行車 Cycling
2 跑步 Running	11 高爾夫球 Golf	20 游泳 Swimming
3 體操 Gymnastics	12 棒球 Baseball	21 跳繩 Rope skipping
4 舞蹈類 Dancing	13 跆拳道 Taekwondo	22 踢毽子 Shuttlecock kicking
5 籃球 Basketball	14 空手道 Karate	23 輪滑 Roller skating
6 排球 Volleyball	15 柔道 Judo	24 其他 Others
7 足球 Football	16 武術 Martial arts	25 沒有能夠掌握的體育鍛煉項目 None
8 網球 Tennis	17 滑冰 Skating	
9 乒乓球 Table tennis	18 滑雪 Skiing	

10. 【多選題】你(孩子)能夠掌握上題中選擇的這些體育鍛煉項目的原因是甚麼?本題為多選題，可選1個或1個以上的答案，如果孩子的回答沒在下面列舉的選項範圍中，請選擇“8、其他”。

【Multiple choice question】Why are you (child) able to do the physical exercises you have chosen in the previous question? This is a multiple choice question. You need to choose at least 1 option. If your answer is not in the options, choose “8. Others”.

1 這些項目我比別人做得好 I have better performance in these exercises than others.	5 學校或者父母要求的 It's required by school/my parents.
2 這些項目很有意思 These exercises are fun.	6 這些項目很容易掌握 It's easy to master the skills of these exercises.
3 這些項目大部分人都在玩，我也跟著玩 Most of us are doing these exercises, and so am I.	7 這些項目讓我認識很多朋友 I could make a lot of new friends when doing those exercises.
4 這些項目大家都很少玩，這樣我顯得與眾不同 It makes me feel special when doing the exercises that others seldom participate.	8 其他 Others

2020年澳門市民體質監測數據登錄冊

Data Registration Manual of
2020 Physical Fitness Study of Macao SAR Residents

11. 【單選題】你(孩子)認為自己身上是不是有某些缺點使你(孩子)不擅長做某些運動，比如因為個子比較矮小而不擅長打籃球等？

【Single choice question】 Do you (child) think you have any shortcoming that affects you to do some exercise, such as being not good at playing basketball due to short in height?

1	是的 Yes	2	不是 No	3	不知道 Don't know
---	-----------	---	----------	---	-------------------

12. 【單選題】你(孩子)認為自己肥胖嗎？

【Single choice question】 Do you (child) think you are fat?

1	非常胖 Very fat	3	剛好 Normal	5	非常瘦 Very thin
2	比較胖 Fat	4	比較瘦 Thin		

13. 【單選題】你(孩子)的父親會陪你(孩子)一起參加校內或校外組織的室外活動嗎？

【Single choice question】 Does your father accompany you (child) to do outdoor activities organized on or off campus?

1	幾乎每次都陪 Almost every time	3	偶爾陪 Occasionally
2	經常陪 Frequently	4	從來不陪 Never

14. 【單選題】你(孩子)的母親會陪你(孩子)一起參加校內或校外組織的室外活動嗎？

【Single choice question】 Does your mother accompany you (child) to do outdoor activities organized on or off campus?

1	幾乎每次都陪 Almost every time	3	偶爾陪 Occasionally
2	經常陪 Frequently	4	從來不陪 Never

15. 【多選題】請問家裏有條件提供而你(孩子)又經常玩耍或使用的娛樂用品都有哪些？

本題為多選題，可選1個或1個以上的答案，如果孩子的回答沒在下面列舉的選項範圍中，請選擇“17、其他”。

【Multiple choice question】 What kind of entertainment products do you (child) often play at home? This is a multiple choice question. You need to choose at least 1 option. If your answer is not in the options, choose “17. Others”.

1	電視 TV	7	足球 Football	13	各種積木類玩具 Toy bricks
2	遊戲機 Game console	8	乒乓球 Table tennis	14	機器人、洋娃娃等玩具 Robot toy, doll, etc.
3	手機 Mobile	9	毽子 Shuttlecock	15	輪滑鞋、滑板 Roller skates, skateboard

兒童青少年（學生：6~22歲）- 小學一年級~小學三年級學生
Children and Adolescents (Students aged 6~22) - (Primary 1~3)

4	電腦/平板電腦 Computer / laptop computer	10	籃球 Basketball	16	網球 Tennis
5	跳繩 Rope skipping	11	羽毛球 Badminton	17	其他 Others
6	兒童腳踏車/自行車 Kid's bike / bicycle	12	排球 Volleyball	18	沒有使用相關用品 None

16. 【單選題】你（孩子）爸爸或媽媽經常鼓勵你（孩子）參加體育活動或鍛煉嗎？

如果爸爸媽媽的態度不同，則按照家裏決策人（做主的人）的意見回答。

【Single choice question】 Does your mom or dad often encourage you (child) to do physical exercise? If your mom and dad have different attitude on this issue, answer the question according to the opinion of the one who is dominant in your family.

1	經常 Often	2	有時候 Sometimes	3	很少 Occasionally	4	從來不 Never
---	-------------	---	------------------	---	--------------------	---	--------------

17. 【單選題】你（孩子）爸爸或媽媽會限制你外出玩耍的時間嗎？如果爸爸媽媽的態度不同，則按照家裏決策人（做主的人）的意見回答。

【Single choice question】 Does your mom or dad give you (child) a time limit for playing outside? If your mom and dad have different attitude on this issue, answer the question according to the opinion of the one who is dominant in your family.

1	經常 Often	2	有時候 Sometimes	3	很少 Occasionally	4	從來不 Never
---	-------------	---	------------------	---	--------------------	---	--------------

18. 【單選題】你（孩子）對自己在學校體育課上的表現滿意嗎？

【Single choice question】 Are you (child) satisfied with your performance in PE class at school?

5	非常滿意 Extremely satisfied	3	一般 Neutral	1	非常不滿意 Extremely dissatisfied
4	滿意 Satisfied	2	不太滿意 Dissatisfied		

19. 【單選題】你（孩子）認為自己的運動能力如何？

【Single choice question】 How would you (child) rate your exercise ability?

1	很好 Very good	2	一般 General	3	比較差 Poor	4	不清楚 Don't know
---	-----------------	---	---------------	---	-------------	---	-------------------

20. 【單選題】你（孩子）在學校體育課上學到的技能和知識，會在課外或校外繼續堅持做嗎？

【Single choice question】 Will you (child) continue to use the skills and knowledge learned in PE class in your extracurricular or after-school physical exercise?

1	全部都會堅持做 All of them	2	有一些會堅持做 Some of them	3	不會堅持做 None of them
---	------------------------	---	-------------------------	---	-----------------------

2020年澳門市民體質監測數據登錄冊

Data Registration Manual of
2020 Physical Fitness Study of Macao SAR Residents

21. 【單選題】你(孩子)喜歡學校體育課上老師教的內容嗎?
【Single choice question】 Do you (child) like your PE class at school?

1	喜歡 (不用回答第22題) I like it (skip Question 22)	2	不喜歡 I don't like it.	3	無所謂 No opinion.
---	---	---	-------------------------	---	--------------------

22. 【多選題】你(孩子)對學校體育課不喜歡或不感興趣的原因是甚麼?本題為多選題，可選1個或1個以上的答案，如果孩子的回答沒在下面列舉的選項範圍中，請選擇“8、其他”。

【Multiple choice question】 What are the reasons you (child) do not like or are not interested in your PE class at school? This is a multiple choice question. You need to choose at least 1 option. If your answer is not in the options, choose “8. Others”.

1	老師講得太枯燥了 The teacher is boring.	5	做得不好的時候，老師總是批評 The teacher always criticizes us when we have poor performance.
2	沒有適合我的體育項目 There is no exercise that suits me.	6	老師很少幫我們解答，給我們建議 The teacher seldom helps us or gives us advice.
3	我不知道體育課對我有甚麼用 I think PE class is useless.	7	體育課上給的體育用品太少，不夠分的 There is too little sports equipment for us to share.
4	我認為體育課沒有任何實際用處 I don't think PE class has any practical purpose.	8	其他 Others

第二部份：家長協助孩子回答部份

Part 2 Questions to be answered by child with assistance of parents

【家長協助孩子填寫時要根據孩子的情況進行圈選，在對應的序號上畫“○”。】

[When assisting your child with these questions, please fill in according to your child's answers, and circle each corresponding number with “○”.]

1. 【單選題】最近1個月，你(孩子)經常到室外參加各種活動或鍛煉嗎(包括出去戶外或在學校的戶外操場玩耍等)?

【Single choice question】 In the recent month, do you (child) often go outside to participate in various physical exercises (including playing outdoors or at the outdoor playground at school)?

1	經常 Often	2	有時候 Sometimes	3	很少 Occasionally	4	從來不 Never
---	-------------	---	------------------	---	--------------------	---	--------------

兒童青少年（學生：6~22歲）- 小學一年級~小學三年級學生
Children and Adolescents (Students aged 6~22) - (Primary 1~3)

2. 【單選題】最近1個月的週末（週六和周日），你（孩子）通常平均每天有多長時間在室外活動或鍛煉？

【Single choice question】 On weekends (Saturdays and Sundays) in the recent month, what is the average daily time you (child) spend on outdoor exercises?

1	沒有 None	3	16-29分鐘 16-29 minutes	5	1小時-不足2小時 1 hour-less than 2 hours
2	1-15分鐘 1-15 minutes	4	30分鐘-不足1小時 30 minutes-less than 1 hours	6	2小時或以上 2 hours or more

3. 【單選題】在上學日(週一至週五)，你(孩子)通常平均每天有多長時間花在看電視、使用手機/電腦/平板電腦等電子產品上？

【Single choice question】 On school days (Monday through Friday), what is the average daily time you (child) spend on watching TV and using electronic devices such as mobile/computers/laptop computers?

1	1~29分鐘 1-29 minutes	6	3個小時~不足4個小時 3 hours ~ less than 4 hours
2	30~59分鐘 30-59 minutes	7	4個小時~不足5個小時 4 hours ~ less than 5 hours
3	60分鐘-89分鐘 60-89 minutes	8	5個小時~不足6個小時 5 hours ~ less than 6 hours
4	90~119分鐘 90-119 minutes	9	6個小時或以上 6 hours or more
5	2個小時~不足3個小時 2 hours ~ less than 3 hours	10	一般沒有 Basically none

4. 【單選題】在休息日(週六、週日或節假日)，你(孩子)通常平均每天有多長時間花在看電視、使用手機/電腦/平板電腦等電子產品上？

【Single choice question】 On rest days (Saturdays, Sundays, or holidays), what is the average daily time you (child) spend on watching TV and using electronic devices such as mobile/computers/laptop computers?

1	1~29分鐘 1-29 minutes	6	3個小時~不足4個小時 3 hours ~ less than 4 hours
2	30~59分鐘 30-59 minutes	7	4個小時~不足5個小時 4 hours ~ less than 5 hours
3	60分鐘-89分鐘 60-89 minutes	8	5個小時~不足6個小時 5 hours ~ less than 6 hours
4	90~119分鐘 90-119 minutes	9	6個小時或以上 6 hours or more
5	2個小時~不足3個小時 2 hours ~ less than 3 hours	10	一般沒有 Basically none

2020年澳門市民體質監測數據登錄冊

Data Registration Manual of
2020 Physical Fitness Study of Macao SAR Residents

5. 【多選題】最近1年，你(孩子)一直在持續做哪些體育鍛煉（包括體育課、課外體育活動和校外體育鍛煉）？本題為多選題，可選1個或1個以上的答案，如果孩子持續做的項目不在下面列舉的選項範圍中，請選擇“24、其他”。

【Multiple choice question】What kind of physical exercises have you (child) been doing consistently in the recent year (including PE class, extracurricular exercise and after-school exercise)? This is a multiple choice question. You need to choose at least 1 option. If your answer is not in the options, choose “24. Others”.

1	步行 Walking	10	羽毛球 Badminton	19	騎自行車 Cycling
2	跑步 Running	11	高爾夫球 Golf	20	游泳 Swimming
3	體操 Gymnastics	12	棒球 Baseball	21	跳繩 Rope skipping
4	舞蹈類 Dancing	13	跆拳道 Taekwondo	22	踢毽子 Shuttlecock kicking
5	籃球 Basketball	14	空手道 Karate	23	輪滑 Roller skating
6	排球 Volleyball	15	柔道 Judo	24	其他 Others
7	足球 Football	16	武術 Martial arts	25	沒有持續做的體育鍛煉項目 None
8	網球 Tennis	17	滑冰 Skating		
9	乒乓球 Table tennis	18	滑雪 Skiing		

6. 【單選題】在學校外，你(孩子)近半年內有參加補習或各種非體育類的培訓或興趣班嗎（比如繪畫、音樂類、書法等等興趣班）？

【Single choice question】Have you (child) participated in tutoring or any non-sports training or hobby classes (such as painting, music, and calligraphy classes) outside school in the recent half year?

1	沒有 (不用回答第7題) None (skip Question 7)	3	參加2項 2 classes
2	參加1項 1 class	4	參加3項或以上 3 classes or more

7. 【單選題】你(孩子)每週平均花多長時間參加上題中提及的各種培訓或興趣班？

【Single choice question】What is the average time you (child) spend on the training or hobby classes mentioned above in a typical week?

1	0-59分鐘 0-59 minutes	3	90-119分鐘 90-119 minutes	5	180分鐘或以上 180 minutes or more
2	60-89分鐘 60-89 minutes	4	120-179分鐘 120-179 minutes		

兒童青少年（學生：6~22歲）- 小學一年級~小學三年級學生
Children and Adolescents (Students aged 6~22) - (Primary 1~3)

8. 【單選題】本學期你(孩子)平均每週會有多少次上體育課？(當兩堂體育課是連著一起上時，也只記為1次；如果不是連著上就記為2次)。

【Single choice question】 How many PE classes do you (child) take in a typical week in this semester (if two PE classes are arranged consecutively, count as one; if not, count as two)?

1	1次 1 time	3	3次 3 times	5	5次或以上 5 times or more
2	2次 2 times	4	4次 4 times	6	0次(不用回答第9、10題) 0 time (skip Questions 9, 10)

9. 【單選題】你(孩子)每次上體育課的時間大概是多長？

【Single choice question】 How long is each PE class you (child) take?

1	不足30分鐘 Less than 30 minutes	2	30-59分鐘 30-59 minutes	3	60-89分鐘 60-89 minutes	4	90分鐘或以上 90 minutes or more
---	--------------------------------	---	--------------------------	---	--------------------------	---	-------------------------------

10. 【單選題】多數情況下，你(孩子)上體育課進行體育活動或鍛煉時的身體感受是甚麼樣的？

【Single choice question】 Generally speaking, how do you (child) feel physically when exercising in PE class?

1	呼吸平穩、和平常差不多、沒有特別感覺 Breathing and heart rate remaining the same as usual	2	微微出汗、呼吸加快、心跳有點快 Slight sweating with slightly increased breathing & heart rate	3	出汗較多、心跳明顯加快、上氣不接下氣 Increased sweating with significantly increased breathing & heart rate
---	--	---	---	---	--

11. 【單選題】除學校體育課外，最近1個月，你(孩子)平均每週會有多少次參加體育鍛煉（包括課外體育活動和校外體育鍛煉）？

【Single choice question】 In addition to PE classes in school, what is your (child's) average frequency of doing physical exercise (including extracurricular exercise and after-school exercise) in a typical week in the recent month?

1	平均每週7次或以上 7 times or more on average per week	5	平均每週3次 3 times on average per week
2	平均每週6次 6 times on average per week	6	平均每週2次 2 times on average per week
3	平均每週5次 5 times on average per week	7	平均每週1次 1 time on average per week
4	平均每週4次 4 times on average per week	8	0次(不用回答第12、13題) 0 time (skip Questions 12, 13)

2020年澳門市民體質監測數據登錄冊

Data Registration Manual of
2020 Physical Fitness Study of Macao SAR Residents

12. 【單選題】除學校體育課外，多數情況下，你(孩子)每次進行體育活動或鍛煉(比如課外體育活動、校外體育鍛煉)的持續時間大概是多長？

【Single choice question】Generally speaking, what is your (child's) average duration of physical exercise (such as extracurricular exercise and after-school exercise) each time, in addition to PE classes in school?

1	不足30分鐘 Less than 30 minutes	2	30-59分鐘 30-59 minutes	3	60-89分鐘 60-89 minutes	4	90分鐘或以上 90 minutes or more
---	--------------------------------	---	--------------------------	---	--------------------------	---	-------------------------------

13. 【單選題】除學校體育課外，多數情況下，你(孩子)進行體育活動或鍛煉(比如課外體育活動、校外體育鍛煉)時的身體感受是甚麼樣的？

【Single choice question】Generally speaking, how do you (child) feel physically when exercising (such as extracurricular exercise and after-school exercise), in addition to PE classes in school?

1	呼吸平穩、和平常差不多、 沒有特別感覺 Breathing and heart rate remaining the same as usual	2	微微出汗、呼吸加快、心跳 有點快 Slight sweating with slightly increased breathing & heart rate	3	出汗較多、心跳明顯加快、 上氣不接下氣 Increased sweating with significantly increased breathing & heart rate
---	--	---	---	---	--

14. 【單選題】你(孩子)通常每週有幾天進行力量練習(包括俯臥撐、仰臥起坐、引體向上、深蹲等徒手練習或使用啞鈴、彈力帶等健身器械的練習)？

【Single choice question】How many days in a week do you (child) do strength exercises (including bodyweight training such as push-ups, sit-ups, pull-ups, and squats; or equipment workout such as using dumbbells and elastic bands)?

1	1天 1 day	3	3天 3 days	5	5天 5 days	7	7天 7 days
2	2天 2 days	4	4天 4 days	6	6天 6 days	8	0天 0 day

15. 【單選題】你(孩子)的父親經常進行體育鍛煉嗎？

【Single choice question】Does your (child's) father often exercise?

1	經常 Often	2	偶爾 Seldom	3	從不 Never	4	不知道 Don't know
---	-------------	---	--------------	---	-------------	---	-------------------

16. 【單選題】你(孩子)的母親經常進行體育鍛煉嗎？

【Single choice question】Does your (child's) mother often exercise?

1	經常 Often	2	偶爾 Seldom	3	從不 Never	4	不知道 Don't know
---	-------------	---	--------------	---	-------------	---	-------------------

兒童青少年（學生：6~22歲）- 小學一年級~小學三年級學生
Children and Adolescents (Students aged 6~22) - (Primary 1~3)

17. 【單選題】你(孩子)的父親不上班的時候最經常做的事情是甚麼？如果選擇沒在下面列舉的選項範圍中，請選擇“9、其他”。

【Single choice question】What does your (child's) father most frequently do when he is not at work? If your answer is not in the options, choose "9. Others".

1	看電視/玩電腦/玩手機等電子產品 Watching TV or using electronic devices such as computers and mobile.	6	在家裏工作 Working at home
2	陪我/兄弟姐妹上輔導班/興趣班 Accompanying me/my sibling(s) to tutoring/hobby classes	7	參加體育鍛煉 Doing physical exercises
3	陪我/兄弟姐妹一塊出去玩 Accompanying me/my sibling(s) to play outdoor activities	8	陪我/兄弟姐妹溫習或做功課 Assisting me/my sibling(s) with our homework
4	做家務（做飯、搞衛生） Doing house chores (cooking, cleaning)	9	其他 Others
5	讀書、看報 Reading books and newspapers	10	不知道 Don't know

18. 【單選題】你(孩子)的母親不上班的時候最經常做的事情是甚麼？如果選擇沒在下面列舉的選項範圍中，請選擇“9、其他”。

【Single choice question】What does your (child's) mother most frequently do when she is not at work? If your answer is not in the options, choose "9. Others".

1	看電視/玩電腦/玩手機等電子產品 Watching TV or using electronic devices such as computers and mobile.	6	在家裏工作 Working at home
2	陪我/兄弟姐妹上輔導班/興趣班 Accompanying me/my sibling(s) to tutoring/hobby classes	7	參加體育鍛煉 Doing physical exercises
3	陪我/兄弟姐妹一塊出去玩 Accompanying me/my sibling(s) to play outdoor activities	8	陪我/兄弟姐妹溫習或做功課 Assisting me/my sibling(s) with our homework
4	做家務（做飯、搞衛生） Doing house chores (cooking, cleaning)	9	其他 Others
5	讀書、看報 Reading books and newspapers	10	不知道 Don't know

19. 【單選題】你(孩子)家離公園或商場近嗎？

【Single choice question】Is your (child's) home near a park or a mall?

1	非常遠 Very far	2	比較遠 Relatively far	3	比較近 Relatively close	4	很近 Very close
---	-----------------	---	-----------------------	---	-------------------------	---	------------------

20. 【單選題】你(孩子)在住所周邊玩耍安不安全？

【Single choice question】Is it safe for you (child) to play in the surroundings of your residence?

1	安全 Safe	2	不安全 Unsafe
---	------------	---	---------------

2020年澳門市民體質監測數據登錄冊

Data Registration Manual of
2020 Physical Fitness Study of Macao SAR Residents

21. 【單選題】在住所周邊，你(孩子)有認識的朋友，平時可以一塊玩耍的嗎？

【Single choice question】 Do you (child) know any friends that you can play with in the surroundings of your residence?

1	有 Yes	2	沒有 No
---	----------	---	----------

22. 【單選題】在休息日（週六和週日或節假日），你(孩子)會在住所附近玩耍嗎？

【Single choice question】 Do you (child) play in the surroundings of your residence on rest days (Saturdays, Sundays, or holidays)?

1	會 (不用回答第23題) Yes (skip Question 23)	2	不會 No
---	--	---	----------

23. 【多選題】在休息日（週六和週日或節假日），你(孩子)不會在住所附近玩耍的原因有哪些？本題為多選題，可選1個或1個以上的答案，如果原因不在下面列舉的選項範圍中，請選擇“11、其他”。

【Multiple choice question】 What are the reasons you (child) do not play in the surroundings of your residence on rest days (Saturdays, Sundays, or holidays)? This is a multiple choice question. You need to choose at least 1 option. If your answer is not in the options, choose “11. Others”.

1	車太多了 There are too many vehicles	7	要參加補習班 I need to go to tutoring class
2	沒有合適的場地 There is a lack of suitable venues	8	要在家看電視、玩手機 I need to watch TV and use mobile at home
3	寵物太多 There are too many pets	9	父母沒陪 My parents could not accompany me
4	到處是垃圾，太髒 There is trash all over the place, and the hygiene is poor	10	沒有適合的設施器材 There is a lack of suitable facilities
5	社區裏沒有認識的朋友 I don't have friends in this community	11	其他 Others
6	要寫作業 I need to do homework		

24. 【單選題】在上學日(週一至週五)，你(孩子)通常平均每天睡眠時長是多少（含午休）？

【Single choice question】 On school days (Monday through Friday), what is your (child's) average sleep time (including naps) per day?

1	8個小時以下 Less than 8 hours	4	10個小時至不足11個小時 10 hours ~ less than 11 hours
2	8個小時至不足9個小時 8 hours ~ less than 9 hours	5	11個小時至不足12個小時 11 hours ~ less than 12 hours
3	9個小時至不足10個小時 9 hours ~ less than 10 hours	6	12個小時或以上 12 hours or more

兒童青少年（學生：6~22歲）- 小學一年級~小學三年級學生
Children and Adolescents (Students aged 6~22) - (Primary 1~3)

25. 【單選題】在休息日(週六、週日或節假日)，你(孩子)通常平均每天睡眠時長是多少(含午休)？

[Single choice question] On rest days (Saturdays, Sundays, or holidays), what is your (child's) average sleep time (including naps) per day?

1	8個小時以下 Less than 8 hours	4	10個小時至不足11個小時 10 hours - less than 11 hours
2	8個小時至不足9個小時 8 hours ~ less than 9 hours	5	11個小時至不足12個小時 11 hours - less than 12 hours
3	9個小時至不足10個小時 9 hours ~ less than 10 hours	6	12個小時或以上 12 hours or more

26. 【填空題】你(孩子)通常每天有多少時間坐著或者靠著(包括坐著上文化課、做功課、看電視、使用電腦、吃飯、乘車等等坐著的時間)？

[Blank-filling question] What is your (child's) average sitting or reclining time (including the sitting time for school classes, homework, watching TV, using computers, eating, and transportation, etc.) per day?

請填寫：
Please fill in the blanks: 小時 分鐘。
hours minutes

第三部份：家長回答部份
Part 3 Questions to be answered by parents

【請您選擇合適的選項，在對應的序號上畫“○”。】
[Choose the proper answer and circle its corresponding number with “○”.]

1. 【單選題】以下說法，請您根據您對孩子的瞭解進行選擇。

[Single choice question] Please choose from the following descriptions according to your understanding of your child

題目 Question	非常符合 Very consistent	比較符合 Slightly consistent	一般 Neutral	不太符合 Not quite consistent	非常不符合 Very inconsistent
1) 比較好動 My child is physically active.	5	4	3	2	1
2) 喜歡做相對安靜的事情 My child likes activities that are relatively quiet.	5	4	3	2	1
3) 與別人相處比較謹慎 My child is cautious with others.	5	4	3	2	1
4) 比較喜歡獨處 My child prefers staying alone.	5	4	3	2	1

2020年澳門市民體質監測數據登錄冊

Data Registration Manual of
2020 Physical Fitness Study of Macao SAR Residents

題目 Question	非常符合 Very consistent	比較符合 Slightly consistent	一般 Neutral	不太符合 Not quite consistent	非常不符合 Very inconsistent
5) 喜歡跟別人競爭 My child likes to compete with others	5	4	3	2	1
6) 很容易會高興 My child is easily pleased.	5	4	3	2	1

2. 【單選題】您認為孩子當前的活動鍛煉量是否足夠？

【Single choice question】Do you think your child has adequate amount of exercise currently?

1	非常充足 Very sufficient	3	一般 Neutral	5	非常缺乏 Very insufficient
2	比較充足 Relatively sufficient	4	不太夠 Insufficient		

3. 【單選題】您日常進行體育鍛煉的頻率如何？

【Single choice question】What is your exercise frequency?

1	每週3次以上 More than 3 times per week	3	每月1-3次 1-3 times per month	5	從不進行鍛煉 Never
2	每週1-3次 1-3 times per week	4	更低頻率 Lower frequency than the above		

4. 【單選題】您願意花錢讓孩子參加體育活動和鍛煉嗎（比如參加足球班、舞蹈班或購置鍛煉器材、購買專業裝備等）？

【Single choice question】Are you willing to spend money on your child to participate in physical exercise (such as attending football classes, dancing classes; or buying exercise devices, professional equipments, etc.)?

1	非常不願意 Absolutely not	3	一般 Neutral	5	非常願意 Absolutely
2	不太願意 Unwilling	4	比較願意 Willing		

5. 【單選題】孩子的父親是否存在肥胖的情況？

【Single choice question】Is your child's father fat?

1	是 Yes	2	否 No
---	----------	---	---------

兒童青少年（學生：6~22歲）- 小學一年級~小學三年級學生
Children and Adolescents (Students aged 6~22) - (Primary 1~3)

6. 【單選題】孩子的母親是否存在肥胖的情況？

【Single choice question】Is your child's mother fat?

1 是 Yes	2 否 No
------------	-----------

此問卷第三部份的填寫人是孩子的 Part 3 of the questionnaire is filled out by the _____ of the child.

1 父親 Father	2 母親 Mother	3 爺爺奶奶或外公外婆 Grandpa/grandma	4 其他人 Others
----------------	----------------	--------------------------------	-----------------

問卷完畢。謝謝。

This is the end of the questionnaire.
Thank you for participating.

三. 檢測指標 (由監測人員在監測現場填寫)

Testing indicators (to be filled in by examiner on site)

1. 身高 (cm) Height (cm)	<input type="text"/> <input type="text"/> <input type="text"/> . <input type="text"/>
2. 坐高 (cm) Sitting height (cm)	<input type="text"/> <input type="text"/> . <input type="text"/>
3. 體重 (kg) Weight (kg)	<input type="text"/> <input type="text"/> <input type="text"/> . <input type="text"/>
4. 胸圍 (cm) Chest circumference (cm)	<input type="text"/> <input type="text"/> <input type="text"/> . <input type="text"/>
5. 腰圍 (cm) Waist circumference (cm)	<input type="text"/> <input type="text"/> <input type="text"/> . <input type="text"/>
6. 臀圍 (cm) Hip circumference (cm)	<input type="text"/> <input type="text"/> <input type="text"/> . <input type="text"/>
7. 體脂率 (%) Body fat percentage (%)	<input type="text"/> <input type="text"/> . <input type="text"/>

2020年澳門市民體質監測數據登錄冊

Data Registration Manual of
2020 Physical Fitness Study of Macao SAR Residents

8. 肩寬 (cm) Shoulder width (cm)	<input type="text"/> <input type="text"/> . <input type="text"/>
9. 骨盆寬 (cm) Pelvis width (cm)	<input type="text"/> <input type="text"/> . <input type="text"/>
10. 足長 (cm) Foot length (cm)	<input type="text"/> <input type="text"/> . <input type="text"/>
11. 安靜脈搏 (次/分) Resting pulse (bpm)	<input type="text"/> <input type="text"/> <input type="text"/>
12. 收縮壓 (mmHg) Systolic blood pressure (mmHg)	<input type="text"/> <input type="text"/> <input type="text"/>
13. 舒張壓 (mmHg) Diastolic blood pressure (mmHg)	<input type="text"/> <input type="text"/> <input type="text"/>
14. 肺活量 (ml) Vital capacity (ml)	<input type="text"/> <input type="text"/> <input type="text"/> <input type="text"/>
15. 斜身引體 (次) (6~12歲男) 引體向上 (次) (13~22歲男) 一分鐘仰臥起坐 (次) (6~22歲女) Inclined pull-ups (times) (6~12 years M) / Pull-ups (times) (13~22 years M) / One-minute sit-ups (times) (6~22 years F)	<input type="text"/> <input type="text"/> <input type="text"/>
16. 立定跳遠 (cm) Standing long jump (cm)	<input type="text"/> <input type="text"/> <input type="text"/>
17. 50米跑 (秒) 50m run (sec)	<input type="text"/> <input type="text"/> . <input type="text"/>
18. 50×8往返跑 (秒) (6~12歲) / 800米跑 (秒) (13~22歲女) / 1000米跑 (秒) (13~22歲男) 50m×8 shuttle run (sec) (6~12 years) / 800m run (sec) (13~22 years F) / 1000m run (sec) (13~22 years M)	<input type="text"/> <input type="text"/> <input type="text"/> . <input type="text"/>
19. 握力 (kg) Grip strength (kg)	<input type="text"/> <input type="text"/> . <input type="text"/>

2. Primary Students (Primary 4~6)

2020

澳門市民體質監測
Physical Fitness Study of Macao SAR Residents

數據登錄冊
Data Registration Manual

兒童青少年(學生：6~22歲)
Children and Adolescents
(Students aged 6~22)

(小學四年級~小學六年級學生)
(Primary 4~6)

 澳門特別行政區政府體育局
Sports Bureau, Macao SAR



歡迎閣下參加2020年澳門市民體質監測！澳門市民體質監測是特區政府為推動大眾健身活動的開展而進行的調查研究。在此首先感謝閣下對監測的支持並認真、如實地填寫問卷，我們保證對閣下的個人資料保密，有關資料不會獨立出現或使用，它將是整體數據的組成部分。再次對閣下的真誠參與表示感謝！

如對調查內容和檢測項目有任何疑問，歡迎向體育局運動醫學中心垂詢！

電話：28810896，88934540

Thank you for participating in our 2020 Physical Fitness Study! This study is organized by the Macao SAR Government to promote Sports for All. We are grateful for your participation. Your honesty and sincerity in filling out the questionnaire are appreciated. We promise to keep your personal data confidential and we will not publish or use your data individually. It will only be used as part of the whole study for statistical purposes. Again, we would like to extend our most sincere gratitude for your participation!

For any enquiries regarding the questionnaire or testing items, please feel free to contact Sports Medicine Centre of Macao Sports Bureau!
Telephone: 28810896, 88934540

2020年澳門市民體質監測數據登錄冊

Data Registration Manual of
2020 Physical Fitness Study of Macao SAR Residents

體育局轄下運動醫學中心預先聲明

Declaration
Sports Medicine Centre of Macao Sports Bureau

本聲明旨在向個人資料當事人或相關家長或監護人確保遵守第8/2005號法律“個人資料保護法”所規範的事宜。

This declaration is intended to assure data subjects or their parents or guardians that we will strictly comply with the relevant provisions of Act 8/2005 - Personal Data Protection Act.

1. 處理個人資料的負責人—體育局，地址設於澳門羅理基博士大馬路818號。代表—體育局局長。

Personal data controller: Macao Sports Bureau, at Av. Dr. Rodrigo Rodrigues, n.º 818, Macao.
Representative - President of Macao Sports Bureau.

2. 處理個人資料的目的—進行澳門市民體質監測，以便為制定日後關於體育及醫療護理的政策提供科學數據。收集的數據旨在更新僅為統計用途的數據庫。

Purposes of processing personal data: To conduct the physical fitness study for Macao residents, and provide scientific references for the development of relevant policies regarding sports and medical care. Data collected through the physical fitness study will only be used to update the database for statistical purposes.

3. 個人資料當事人類別—參與是次計劃的澳門居民（隨年齡抽樣）。

Categories of subjects with personal data: Macao residents participated in the study (random sampling by age).

4. 個人資料接收者—個人資料當事人（或相關家長或監護人），運動醫學中心及國家體育總局體育科學研究所。

Personal data recipients: Data subjects (or their parents or guardians), Sports Medicine Centre and China Institute of Sport Science.

5. 接收及處理個人資料的條件—個人資料當事人（或相關家長或監護人）享有第8/2005號法律賦予的所有權利如查閱權及更正所收集的個人資料。運動醫學中心承諾對不正確的數據進行更正，刪除或封鎖。

Conditions of receiving and processing personal data: Data subjects (or their parents or guardians) are entitled by Act 8/2005 - Personal Data Protection Act to the rights to access and rectify their own personal data collected. The Sports Medicine Centre hereby commits to take proper measures to rectify, delete or block any incorrect data.

兒童青少年（學生：6~22歲）- 小學四年級~小學六年級學生
Children and Adolescents (Students aged 6~22) - (Primary 4~6)

6.處理個人資料的安全和保密性—對處理及編輯個人資料絕對保密及採取適當措施以確保其安全。

Security and confidentiality of processing personal data: Appropriate measures are implemented to process and edit the personal data to ensure strict confidentiality, safety and security of the data.

本人已明白上述內容權益

I, the undersigned, am aware of the contents and my legal rights in the above declaration.

(個人資料當事人或家長或監護人簽名)
(Signature of subject providing personal
data/parents/guardian)

_____/_____/_____
(日) (月) (年)
(DD) (MM) (YY)

姓 名 :	_____
Name:	_____
性 別 :	_____
Gender:	_____
年 齡 :	_____ (周歲)
Age:	_____ (years)
就讀學校 :	_____
School:	_____
聯繫電話 :	_____
Phone:	_____

2020年澳門市民體質監測數據登錄冊

Data Registration Manual of
2020 Physical Fitness Study of Macao SAR Residents

一.分類編碼（學生個人資料，小學生可由家長協助填寫）

General Information (Personal information of primary student can be filled in by the parents)

填寫方法：

填寫選擇題時請將選擇答案的序號填入相應的方格中，如選答案（1），則在方格內填1；序號為兩位數時，兩位數字填入同一方格，如選項為（11），則將 填入同一方格，即填為 。在填寫多項選擇題時，如果僅選擇一個或兩個答案，則應在剩餘方格內填0。

Instructions for filling:

Please fill in the boxes with the corresponding numbers. For example, if the chosen answer is (1), fill in the box with "1". If the chosen option is a two digit number, write both digits in the same box. e.g. If the chosen option is (11), fill in the box with . For multiple choice questions, if only one or two option(s) were chosen, please fill in the remaining blank box(es) with "0".

1.澳門居民身份證號碼 Macao ID card number	<input type="text"/> <input type="text"/> <input type="text"/> <input type="text"/> <input type="text"/> <input type="text"/> <input type="text"/> <input type="text"/>		
2.性別 Gender	(1) 男 Male	(2) 女 Female	<input type="text"/>
3.出生日期 Date of birth	<input type="text"/> <input type="text"/> <input type="text"/> <input type="text"/> 年 Y	<input type="text"/> <input type="text"/> 月 M	<input type="text"/> <input type="text"/> 日 D
4.測試日期（由監測人員填寫） Examination date (to be filled in by examiner)	<input type="text"/> <input type="text"/> <input type="text"/> <input type="text"/> 年 Y	<input type="text"/> <input type="text"/> 月 M	<input type="text"/> <input type="text"/> 日 D
5.學校代碼（由監測人員填寫） School code number (filled in by examiner)	<input type="text"/> <input type="text"/> <input type="text"/> <input type="text"/>		
6.測試序號（由監測人員填寫） Serial number (filled in by examiner)	<input type="text"/> <input type="text"/> <input type="text"/> <input type="text"/>		
7.居住在澳門的年限（年）（指連續在澳門居住的年限，如果離開澳門的時間超過1年，則要由回澳門居住起重新計算居澳年限） Years of residence in Macao (It refers to years of continuous residence in Macao. If you had left Macao for over 1 year, years of residence in Macao should be recalculated from the time of returning to Macao.)	<input type="text"/> <input type="text"/>		

兒童青少年（學生：6~22歲） - 小學四年級~小學六年級學生
Children and Adolescents (Students aged 6~22) - (Primary 4~6)

<p>8.在學校就讀年級 School grade</p> <p>(1) 小學四年級 Primary 4</p> <p>(2) 小學五年級 Primary 5</p> <p>(3) 小學六年級 Primary 6</p>	<input type="checkbox"/>
<p>9.出生地 Place of birth</p> <p>(1) 中國大陸 Mainland China</p> <p>(2) 澳門 Macao</p> <p>(3) 香港 Hong Kong</p> <p>(4) 葡萄牙 Portugal</p> <p>(5) 其他 Others</p>	<input type="checkbox"/>
<p>10.居住地所屬堂區 Parish of residence</p> <p>(1) 聖方濟各堂區（路環） Paróquia de São Francisco Xavier (Coloane)</p> <p>(2) 聖嘉模堂區（氹仔） Paróquia de Nossa Senhora do Carmo (Taipa)</p> <p>(3) 風順堂區（包括媽閣山、西望洋山、下環及內港一帶） Paróquia de S. Lourenço (Zonas das Colinas da Barra e da Penha, da Praia do Manduco e do Porto Interior)</p> <p>(4) 大堂區（新馬路一帶、南灣、水坑尾、新口岸南北地段及南灣湖發展區） Paróquia da Sé Catedral (Zonas da Almeida Ribeiro, da Praia Grande, da Rua do Campo, dos Lotes norte e sul do Porto Exterior e da Zona do Lago Nam Van)</p> <p>(5) 花王堂區（聖安多尼堂區，在澳門西部，包括高士德大馬路、新橋和沙梨頭） Paróquia de Santo António (Zonas da Freguesia de Santo António, do Oeste de Macau, incluindo Av. Horta e Costa, de San Kiu e do Patane)</p> <p>(6) 望德堂區（包括荷蘭園、松山一帶） Paróquia de S. Lázaro (Zona do Conselheiro Ferreira de Almeida e da Colina da Guia)</p> <p>(7) 花地瑪堂區（俗稱北區，包括青洲、台山、黑沙環、筷子基和水塘） Paróquia de Nossa Senhora de Fátima (Zonas do Norte, incluindo Ilha Verde, Tamagnini Barbosa, Areia Preta, Fái Chi Kei e Reservatório)</p>	<input type="checkbox"/>
<p>11.近5年曾患過何種疾病（經醫院確診的疾病）（選擇“無”者請直接回答問題第13題） Any hospital-diagnosed diseases suffered within the past 5 years? (If the answer is “no”, skip to Question 13)</p> <p>(1) 有 Yes</p> <p>(2) 無 No</p>	<input type="checkbox"/>

2020年澳門市民體質監測數據登錄冊

Data Registration Manual of
2020 Physical Fitness Study of Macao SAR Residents

12. 患病種類 (患病者按主次順序, 最多可填寫3項) Diseases suffered (in order of precedence, choose up to 3 diseases)			<input type="text"/>	<input type="text"/>	<input type="text"/>
(1) 氣管炎 Tracheitis	(2) 肺炎 Pneumonia	(3) 哮喘 Asthma			
(4) 過敏性鼻炎 Allergic rhinitis	(5) 腹瀉病 Diarrhea	(6) 腸胃炎 Gastroenteritis			
(7) 腎炎 Nephritis	(8) 扁桃腺炎 Tonsillitis	(9) 肝炎 Hepatitis			
(10) 肺結核 Tuberculosis	(11) 水痘 Varicella	(12) 脊柱彎曲異常 Scoliosis			
(13) 流行性腮腺炎 Mumps	(14) 貧血 Anemia	(15) 心臟病 Heart disease			
(16) 糖尿病 Diabetes	(17) 意外傷害(造成人體的損傷而需要醫治或影響了正常的活動) Accidental injury (injury to the body that needs treatments, or injury that affects normal activities)	(18) 其他 Others			
13. 有沒有每天刷牙習慣 Do you brush your teeth every day?			<input type="checkbox"/>		
(1) 有 Yes	(2) 無 No				
14. 除刷牙外, 有沒有每天使用牙線 Do you use dental floss in addition to tooth-brushing every day?			<input type="checkbox"/>		
(1) 有 Yes	(2) 無 No				
15. 過去12個月有沒有到牙醫診所進行牙科檢查 Did you go to a dental clinic for dental examination within the past 12 months?			<input type="checkbox"/>		
(1) 有 Yes	(2) 無 No				
16. 是否有齲齒 (選擇“無”或“不知道”者請直接回答問題第18題) Do you have any decayed tooth? (If the answer is “no” or “don’t know”, skip to Question 18)			<input type="checkbox"/>		
(1) 有 Yes	(2) 無 No	(3) 不知道 Don't know			

兒童青少年（學生：6~22歲） - 小學四年級~小學六年級學生
Children and Adolescents (Students aged 6~22) - (Primary 4~6)

17. 如有齲齒，有沒有到牙醫診所進行治療？ If yes, have you visited a dental clinic for treatment? (1) 有 Yes (2) 無 No	<input type="checkbox"/>
18. 是否有親兄弟姐妹？ Do you have any siblings? (1) 沒有 No (2) 有1個 1 (3) 有2個或以上 2 or more	<input type="checkbox"/>
19. 是否有影響開展體育活動的先天性疾病或者殘疾？ Do you have any congenital disease or disability that affects physical activity? (1) 沒有 No (2) 有 (請注明 Yes (Please specify _____)	<input type="checkbox"/>
20. 是否與父母住在一起共同生活？ Do you live with your parents? (1) 是 Yes (2) 否 No (3) 只與父或母任一方同住 Live with one of my parents	<input type="checkbox"/>

2020年澳門市民體質監測數據登錄冊

Data Registration Manual of
2020 Physical Fitness Study of Macao SAR Residents

二. 健身素養問卷 Fitness Literacy

A-健身知識(由學生獨立回答)

Fitness knowledge (to be answered by student independently)

A1. 【單選題】您認為以下說法是否正確，正確選1、不正確選2、不知道選3，並在您選的數字上畫“○”。

[Single choice question] Which of the following descriptions do you think are correct? Choose 1 for “Correct”, 2 for “Incorrect”, 3 for “Don’t know”, and circle each corresponding number with “○”.

題目 Question	正確 Correct	不正確 Incorrect	不知道 Don't know
1) 劇烈運動時，只能用鼻子呼吸 During strenuous exercise, you should only breathe through the nose	1	2	3
2) 運動時抽筋，應該立即休息 Take a rest immediately when there is muscle cramp during exercising.	1	2	3
3) 每次鍛煉前要做必要的伸展運動 Do necessary stretching before exercising.	1	2	3
4) 彎道跑時，身體要向跑道內傾斜 When running round the bend, incline your body to the inside of the track.	1	2	3
5) 體育鍛煉後可以立即吃飯 You can eat immediately after exercising.	1	2	3
6) 運動前不能吃太飽 You should not eat too much before exercising.	1	2	3
7) 運動後，為緩解疲勞，可以多吃一些蔬菜和水果 After exercising, you can eat more vegetables and fruits to relieve fatigue.	1	2	3
8) 蹲踞式起跑需要在聽到“預備”口令後，抬起臀部，身體重心同時前移，形成臀部高於肩、肩超過起跑線的身體姿勢 To do a crouch start, when hearing the command “Get set”, you should raise the hip, and move the body's center of gravity forward at the same time to form a body posture with hips higher than shoulders and shoulders exceeding the starting line.	1	2	3
9) 站立體前屈需要兩腿並立，膝蓋伸直，上體與腿盡量貼近 To do a standing forward bend, you should keep both legs standing together, with straight knees, and upper body close to legs as much as possible.	1	2	3
10) 原地高抬腿運動的節奏要快，身體需要微微向後傾 To do a high-knee running in place, you should keep a fast pace and lean back the body slightly.	1	2	3

兒童青少年（學生：6~22歲）- 小學四年級~小學六年級學生
Children and Adolescents (Students aged 6~22) - (Primary 4~6)

B-健身態度(由學生獨立回答)

Fitness attitude (to be answered by student independently)

B1. 【單選題】以下說法你是否同意，非常不同意選1、不太同意選2、一般選3、比較同意選4、非常同意選5，並在你選的數字上畫“○”

【Single choice question】Which of the following descriptions do you agree with? Choose 1 for “Strongly disagree”, 2 for “Slightly disagree”, 3 for “Neutral”, 4 for “Relatively agree”, 5 for “Strongly agree”, and circle each corresponding number with “○”.

題目 Question	非常不同意 Strongly disagree	不太同意 Slightly disagree	一般 Neutral	比較同意 Relatively agree	非常同意 Strongly agree
1) 體育鍛煉可以強身健體 Doing physical exercises can strengthen our body.	1	2	3	4	5
2) 體育鍛煉有利於減少脂肪，避免過度肥胖 Doing physical exercises helps to reduce fat and avoid obesity.	1	2	3	4	5
3) 體育鍛煉有助於增強自信心 Doing physical exercises can improve self-confidence.	1	2	3	4	5
4) 體育鍛煉能夠讓自己交到更多朋友 Doing physical exercises can help us to make more friends.	1	2	3	4	5

B2. 【單選題】以下說法是否符合你的真實情況?非常不符合選1、不太符合選2、一般選3、比較符合選4、非常符合選5，並在你選的數字上畫“○”。

【Single choice question】Which of the following descriptions is consistent with your situation? Choose 1 for “Very inconsistent”, 2 for “Not quite consistent”, 3 for “Neutral”, 4 for “Slightly consistent”, 5 for “Very consistent”, and circle each corresponding number with “○”.

題目 Question	非常不符合 Very inconsistent	不太符合 Not quite consistent	一般 Neutral	比較符合 Slightly consistent	非常符合 Very consistent
5) 體育鍛煉活動非常有用 Doing physical exercises is very useful.	1	2	3	4	5
6) 體育鍛煉活動非常無聊 Doing physical exercises is very boring.	1	2	3	4	5
7) 體育鍛煉活動對身體有害 Doing physical exercise is harmful to my body.	1	2	3	4	5
8) 體育鍛煉的體驗不是很愉快 The experience of exercising is not pleasant.	1	2	3	4	5

2020年澳門市民體質監測數據登錄冊

Data Registration Manual of
2020 Physical Fitness Study of Macao SAR Residents

B3. 【單選題】 以下說法是否符合你的真實情況? 非常不符合選1、不太符合選2、一般選3、比較符合選4、非常符合選5，並在你選的數字上畫“○”。

【Single choice question】 Which of the following descriptions is consistent with your situation? Choose 1 for “Very inconsistent”, 2 for “Not quite consistent”, 3 for “Neutral”, 4 for “Slightly consistent”, 5 for “Very consistent”, and circle each corresponding number with “○”.

題目 Question	非常不符合 Very inconsistent	不太符合 Not quite consistent	一般 Neutral	比較符合 Slightly consistent	非常符合 Very consistent
9) 完成體育課的要求非常困難 It is very difficult for me to complete the required tasks in PE class.	1	2	3	4	5
10) 父母或對我很重要的人(比如爺爺、奶奶、同學、朋友等)不會要求我進行體育鍛煉 My parents or those who are important to me (such as grandpa, grandma, classmates, friends, teachers) would not ask me to do physical exercises.	1	2	3	4	5
11) 如果我願意，體育鍛煉要求的各項指標我都可以達標 I can meet all the required indicators of physical exercises if I want to.	1	2	3	4	5

B4. 【單選題】 以下說法是否符合你的真實情況? 非常不符合選1、不太符合選2、一般選3、比較符合選4、非常符合選5，並在你選的數字上畫“○”。

【Single choice question】 Which of the following descriptions is consistent with your situation? Choose 1 for “Very inconsistent”, 2 for “Not quite consistent”, 3 for “Neutral”, 4 for “Slightly consistent”, 5 for “Very consistent”, and circle each corresponding number with “○”.

題目 Question	非常不符合 Very inconsistent	不太符合 Not quite consistent	一般 Neutral	比較符合 Slightly consistent	非常符合 Very consistent
12) 看到有同學或朋友參加體育鍛煉，就想參與其中 As I saw my classmates or friends doing physical exercise, I want to join them.	1	2	3	4	5
13) 能做到一直堅持參加體育鍛煉 I'm able to keep on exercising.	1	2	3	4	5
14) 給自己制定了一份體育鍛煉的計劃 I have made a physical exercise plan for myself.	1	2	3	4	5

兒童青少年（學生：6~22歲）- 小學四年級~小學六年級學生
Children and Adolescents (Students aged 6~22) - (Primary 4~6)

C-健身技能(由學生獨立回答)

Fitness skills (to be answered by student independently)

C1. 【多選題】你嘗試過的運動項目有哪些？本題為多選題，可選1個或1個以上的答案，請圈選所有你參與過的運動項目，在選項對應的序號上畫“○”。

[Multiple choice question] What kind of physical exercises have you tried? This is a multiple choice question. You need to choose at least 1 option. Choose all the physical exercises you have ever participated, and circle the corresponding number with “○”.

1	健步走 Brisk walking	13	騎自行車 Cycling	25	水球 Water polo
2	中短程跑(1500米內) Short- and middle-distance running(<1,500m)	14	羽毛球 Badminton	26	柔道 Judo
3	長跑(距離超過1500米) Long-distance running (>1,500m)	15	網球 Tennis	27	滑冰 Skating
4	跳高 High jump	16	體操 Gymnastics	28	滑雪 Skiing
5	跳遠 Long jump	17	韻律操（形體操、健美操、體育舞蹈、 舞蹈等） Rhythmic gymnastics (such as gym, aerobics, sport dance, dance, etc.)	29	跳繩 Rope skipping
6	籃球 Basketball	18	游泳 Swimming	30	踢毽子 Shuttlecock kicking
7	排球(包括沙灘排球) Volleyball (including beach volleyball)	19	武術 Martial arts	31	輪滑 Roller skating
8	足球 Football	20	跆拳道 Taekwondo	32	冰球 Ice hockey
9	乒乓球 Table tennis	21	空手道 Karate	33	舉重 Weight-lifting
10	高爾夫球 Golf	22	曲棍球 Hockey	34	標槍 Javelin
11	棒球 Baseball	23	擊劍 Fencing	35	其他 Others
12	鉛球(包括實心球) Shot-put (including solid ball)	24	跨欄 Hurdles	36	沒有參加過任何運動項目 (不用回答C2題) None (skip Question C2)

2020年澳門市民體質監測數據登錄冊

Data Registration Manual of
2020 Physical Fitness Study of Macao SAR Residents

C2. 【多選題】你能夠熟練掌握的運動項目有哪些（熟練是指自己能掌握某項運動的基本技能）？本題為多選題，可選1個或1個以上的答案，請圈選所有你熟練掌握的運動項目，在選項對應的序號上畫“○”。

【Multiple choice question】What kind of physical exercises are you proficient in (Proficiency means that you have perfectly acquired the basic skills of a physical exercise)? This is a multiple choice question. You need to choose at least 1 option. Choose all the physical exercises in which you are proficient, and circle the corresponding number with “○”.

1	健步走 Brisk walking	13	騎自行車 Cycling	25	水球 Water polo
2	中短程跑(1500米內) Short- and middle-distance running(<1,500m)	14	羽毛球 Badminton	26	柔道 Judo
3	長跑(距離超過1500米) Long-distance running (>1,500m)	15	網球 Tennis	27	滑冰 Skating
4	跳高 High jump	16	體操 Gymnastics	28	滑雪 Skiing
5	跳遠 Long jump	17	韻律操（形體操、健美操、體育舞蹈、舞蹈等） Rhythmic gymnastics (such as gym, aerobics, sport dance, dance, etc.)	29	跳繩 Rope skipping
6	籃球 Basketball	18	游泳 Swimming	30	踢毽子 Shuttlecock kicking
7	排球(包括沙灘排球) Volleyball (including beach volleyball)	19	武術 Martial arts	31	輪滑 Roller skating
8	足球 Football	20	跆拳道 Taekwondo	32	冰球 Ice hockey
9	乒乓球 Table tennis	21	空手道 Karate	33	舉重 Weight-lifting
10	高爾夫球 Golf	22	曲棍球 Hockey	34	標槍 Javelin
11	棒球 Baseball	23	擊劍 Fencing	35	其他 Others
12	鉛球(包括實心球) Shot-put (including solid ball)	24	跨欄 Hurdles	36	沒有熟練掌握的運動項目 None

兒童青少年（學生：6~22歲） - 小學四年級～小學六年級學生
Children and Adolescents (Students aged 6~22) - (Primary 4~6)

- C3. 【多選題】你能夠熟練掌握的準備活動有哪些（熟練是指自己獨立會做某項準備活動）？本題為多選題，可選1個或1個以上的答案，請圈選所有你熟練掌握的準備活動，在選項對應的序號上畫“○”。如果沒有熟練掌握的準備活動只圈選10即可。

【Multiple choice question】What kind of warm-up exercises are you proficient in (Proficiency means that you can do warm-up exercises on your own)? This is a multiple choice question. You need to choose at least 1 option. Choose all the warm-up exercises in which you are proficient, and circle the corresponding number with “○”. If the answer is none, circle the number 10.

1 慢跑 Jogging	6 壓腿（包括前壓腿和側壓腿） Leg stretch (including forward lunge stretch and side lunge stretch)
2 腰部運動（如扭腰） Waist movement (such as waist twisting)	7 體前屈 Forward bend
3 肩部運動（轉動肩膀） Shoulder movement (rolling shoulders)	8 原地高抬腿 High-knee running in place
4 關節活動（包括手腕關節、頸關節和腳踝關節） Joint movement (including wrist, neck and ankle joints)	9 其他 Others
5 擴胸運動 Chest expansion exercise	10 沒有熟練掌握的準備活動 None

- C4. 【多選題】你知道以下哪些運動損傷的正確處理方法？本題為多選題，可選1個或1個以上的答案，請圈選所有你會處理的運動損傷情況，在選項對應的序號上畫“○”。

【Multiple choice question】Which of the following exercise injuries can you handle correctly? This is a multiple choice question. You need to choose at least 1 option. Choose all the exercise injuries you can handle correctly, and circle the corresponding number with “○”.

1 擦傷（如膝蓋擦傷） Abrasion (such as skinned knee)	5 中暑 Heatstroke
2 肌肉拉傷（如大腿拉傷） Pulled muscle (such as thigh strain)	6 運動腹痛（如肚子疼） Exercise abdominal pain (such as tummy ache)
3 運動扭傷（如腰扭傷） Sprains (such as lumbar sprain)	7 其他 Others
4 抽筋（如小腿抽筋） Cramps (such as calf cramp)	8 不知道任何運動損傷的正確處理方法 None

2020年澳門市民體質監測數據登錄冊

Data Registration Manual of
2020 Physical Fitness Study of Macao SAR Residents

C5. 【單選題】在體育鍛煉中膝蓋擦傷了，最好應該怎麼處理？請在你選中的選項對應的序號上畫“○”。

【Single choice question】 If the knee is skinned during exercise, what is the best way to handle it? Choose the proper answer and circle its corresponding number with “○”.

1	立即用酒精消毒 Disinfect the wound with alcohol immediately.
2	清水沖洗一下即可 Just rinse the wound with water.
3	清洗後用酒精消毒 Clean the would first, and then disinfect it with alcohol.
4	其他 Others
5	不知道 Don't know

D-健身習慣(由學生獨立回答)

Fitness habits (to be answered by student independently)

D1. 【單選題】本學期你平均每週會有多少次上體育課？請在你選中的選項對應的序號上畫“○”（當兩堂體育課是連著一起上時，也只記為1次；如果不是連著上就記為2次）。

【Single choice question】 How many PE classes do you take in a typical week this semester? Choose the proper answer and circle its corresponding number with “○”. (If two PE classes are arranged consecutively, count as one; if not, count as two.)

1	1次 1 time	4	4次 4 times
2	2次 2 times	5	5次或以上 5 times or more
3	3次 3 times	6	0次(不用回答D2、D3題) 0 time (skip Questions D2, D3)

D2. 【單選題】你每次上體育課的時間大概是多長？請在你選中的選項對應的序號上畫“○”。

【Single choice question】 How long is each PE class you take? Choose the proper answer and circle its corresponding number with “○”.

1	不足30分鐘 Less than 30 minutes	3	60-89分鐘 60-89 minutes
2	30-59分鐘 30-59 minutes	4	90分鐘或以上 90 minutes or more

兒童青少年（學生：6~22歲） - 小學四年級～小學六年級學生
Children and Adolescents (Students aged 6~22) - (Primary 4~6)

D3. 【單選題】多數情況下，你上體育課進行體育活動或鍛煉時的身體感受是甚麼樣的？請在你選中的選項對應的序號上畫“○”。

【Single choice question】 Generally speaking, how do you feel physically when exercising in PE class? Choose the proper answer and circle its corresponding number with “○”.

1	呼吸平穩、和平常差不多、沒有特別感覺 Breathing and heart rate remaining the same as usual	2	微微出汗、呼吸加快、心跳有點快 Slight sweating with slightly increased breathing & heart rate	3	出汗較多、心跳明顯加快、上氣不接下氣 Increased sweating with significantly increased breathing & heart rate
---	--	---	---	---	--

D4. 【單選題】除學校體育課外，最近1個月，你平均每週會有多少次參加體育鍛煉（包括課外體育活動和校外體育鍛煉）？請在你選中的選項對應的序號上畫“○”。

【Single choice question】 In addition to PE classes in school, what is your average frequency of physical exercise (including extracurricular exercise and after-school exercise) in a typical week in the recent month? Choose the proper answer and circle its corresponding number with “○”.

1	平均每週7次或以上 7 times or more on average per week	5	平均每週3次 3 times on average per week
2	平均每週6次 6 times on average per week	6	平均每週2次 2 times on average per week
3	平均每週5次 5 times on average per week	7	平均每週1次 1 time on average per week
4	平均每週4次 4 times on average per week	8	0次(不用回答D5、D6題) 0 time (skip Questions D5, D6)

D5. 【單選題】除學校體育課外，多數情況下，你每次進行體育活動或鍛煉(比如課外體育活動、校外體育鍛煉)的持續時間大概是多長？請在你選中的選項對應的序號上畫“○”。

【Single choice question】 Generally speaking, what is your average duration of exercising (such as extracurricular exercise and after-school exercise) each time, in addition to PE class in school? Choose the proper answer and circle its corresponding number with “○”.

1	不足30分鐘 Less than 30 minutes	3	60-89分鐘 60-89 minutes
2	30-59分鐘 30-59 minutes	4	90分鐘或以上 90 minutes or more

2020年澳門市民體質監測數據登錄冊

Data Registration Manual of
2020 Physical Fitness Study of Macao SAR Residents

D6. 【單選題】除學校體育課外，多數情況下，你進行體育活動或鍛煉（比如課外體育活動、校外體育鍛煉）時的身體感受是甚麼樣的？請在你選中的選項對應的序號上畫“○”。

【Single choice question】Generally speaking, how do you feel physically when exercising (such as extracurricular exercise and after-school exercise), in addition to PE class in school? Choose the proper answer and circle its corresponding number with “○”.

1	呼吸平穩、和平常差不多、沒有特別感覺 Breathing and heart rate remaining the same as usual	2	微微出汗、呼吸加快、心跳有點快 Slight sweating with slightly increased breathing & heart rate	3	出汗較多、心跳明顯加快、上氣不接下氣 Increased sweating with significantly increased breathing & heart rate
---	--	---	---	---	--

D7. 【單選題】你通常每週有幾天進行力量練習（包括俯臥撐、仰臥起坐、引體向上、深蹲等徒手練習或使用啞鈴、彈力帶等健身器械的練習）？請在你選中的選項對應的序號上畫“○”。

【Single choice question】How many days of a week do you usually do strength exercises (including bodyweight training such as push-ups, sit-ups, pull-ups, and squats; or equipment workout such as using dumbbells and elastic bands)? Choose the proper answer and circle its corresponding number with “○”.

1	1天 1 day	3	3天 3 days	5	5天 5 days	7	7天 7 days
2	2天 2 days	4	4天 4 days	6	6天 6 days	8	0天 0 day

兒童青少年（學生：6~22歲）- 小學四年級~小學六年級學生
Children and Adolescents (Students aged 6~22) - (Primary 4~6)

D8. 【多選題】最近一年，你一直在持續做哪些體育鍛煉（包括體育課、課外體育活動和校外體育鍛煉）？本題為多選題，可選1個或1個以上的答案，請圈選你一直在持續做的所有體育鍛煉，在選項對應的序號上畫“○”。

【Multiple choice question】What kind of physical exercises have you been doing consistently in the recent year (including PE class, extracurricular exercise and after-school exercise)? This is a multiple choice question. You need to choose at least 1 option. Choose all the physical exercises you have been doing, and circle each corresponding number with “○”.

1	健步走 Brisk walking	13	騎自行車 Cycling	25	水球 Water polo
2	中短程跑(1500米內) Short- and middle-distance running(<1,500m)	14	羽毛球 Badminton	26	柔道 Judo
3	長跑(距離超過1500米) Long-distance running (>1,500m)	15	網球 Tennis	27	滑冰 Skating
4	跳高 High jump	16	體操 Gymnastics	28	滑雪 Skiing
5	跳遠 Long jump	17	韻律操（形體操、健美操、體育舞蹈、舞蹈等） Rhythmic gymnastics (such as gym, aerobics, sport dance, dance, etc.)	29	跳繩 Rope skipping
6	籃球 Basketball	18	游泳 Swimming	30	踢毽子 Shuttlecock kicking
7	排球(包括沙灘排球) Volleyball (including beach volleyball)	19	武術 Martial arts	31	輪滑 Roller skating
8	足球 Football	20	跆拳道 Taekwondo	32	冰球 Ice hockey
9	乒乓球 Table tennis	21	空手道 Karate	33	舉重 Weight-lifting
10	高爾夫球 Golf	22	曲棍球 Hockey	34	標槍 Javelin
11	棒球 Baseball	23	擊劍 Fencing	35	其他 Others
12	鉛球(包括實心球) Shot-put (including solid ball)	24	跨欄 Hurdles	36	沒有持續做的體育鍛煉項目 (不用回答D9、D10、D11題) None (skip Questions D9, D10, D11)

2020年澳門市民體質監測數據登錄冊

Data Registration Manual of
2020 Physical Fitness Study of Macao SAR Residents

D9. 【單選題】按上述D8題中選擇的這些體育鍛煉項目，以持續鍛煉最久的項目為主，你大概堅持做了多長時間？請在你選中的選項對應的序號上畫“○”。

【Single choice question】 Among the physical exercises chosen in the above Question D8, taking the one with the longest duration as an example, how long have you been doing it? Choose the proper answer and circle its corresponding number with “○”.

1	沒有 N/A	3	1個月或以上，但不足3個月 1 month or more, but less than 3 months	5	半年或以上，但不足1年 Half a year or more, but less than 1 year
2	不足1個月 Less than 1 month	4	3個月或以上，但不足半年 3 months or more, but less than half a year	6	1年或以上 1 year or more

D10. 【單選題】按上述D8題中選擇的這些體育鍛煉項目，你一直堅持做的主要原因是甚麼？請在你選中的選項對應的序號上畫“○”。

【Single choice question】 Among the physical exercises chosen in the above Question D8, what is the main reason that keeps you in doing these? Choose the proper answer and circle its corresponding number with “○”.

1	學校或老師要求 Required by school or teachers	3	自己喜歡 Personal preference	5	其他 Others
2	家長要求 Required by my parents	4	體育考試或測驗需要 Required in PE exams or tests	6	不知道 Don't know

D11. 【單選題】你是如何選中D8題中的這些體育鍛煉項目的？請在你選中的選項對應的序號上畫“○”。

【Single choice question】 How did you choose the physical exercises in Question D8? Choose the proper answer and circle its corresponding number with “○”.

1	自己隨便選的 I chose them randomly.	3	跟著學校的要求做的 I chose them as required by school.	5	哪些項目容易就選哪些 I chose them because they are easy to do.
2	哪些項目練起來方便就選哪些 I chose them because they are convenient to do.	4	跟著家人、朋友或同學等選的 I followed the choices of my family members, friends or schoolmates.	6	諮詢過專業意見 I chose them after seeking for professional advice.

兒童青少年（學生：6~22歲）- 小學四年級~小學六年級學生
Children and Adolescents (Students aged 6~22) - (Primary 4~6)

E-其他習慣(可由家長協助回答)

Other habits (to be answered by student with assistance of parents)

E1. 【填空題】你通常每天有多少時間坐著或者靠著(包括坐著上文化課、做功課、看電視、使用電腦、吃飯、乘車等等坐著的時間)？

【Blank-filling question】 What is your average sitting or reclining time (including the sitting time for school classes, homework, watching TV, using computers, eating, and transportation, etc.) per day?

請填寫：
Please fill in
the blanks: 小時 分鐘。
hours minutes

E2. 【單選題】在上學日(週一至週五)，你通常平均每天睡眠時長是多少(含午休)？

【Single choice question】 On school days (Monday through Friday), what is your average sleep time (including naps) per day?

1	8個小時以下 Less than 8 hours	4	10個小時至不足11個小時 10 hours ~ less than 11 hours
2	8個小時至不足9個小時 8 hours ~ less than 9 hours	5	11個小時至不足12個小時 11 hours ~ less than 12 hours
3	9個小時至不足10個小時 9 hours ~ less than 10 hours	6	12個小時或以上 12 hours or more

E3. 【單選題】在休息日(週六、週日或節假日)，你通常平均每天睡眠時長是多少(含午休)？

【Single choice question】 On rest days (Saturdays, Sundays, or holidays), what is your average sleep time (including naps) per day?

1	8個小時以下 Less than 8 hours	4	10個小時至不足11個小時 10 hours ~ less than 11 hours
2	8個小時至不足9個小時 8 hours ~ less than 9 hours	5	11個小時至不足12個小時 11 hours ~ less than 12 hours
3	9個小時至不足10個小時 9 hours ~ less than 10 hours	6	12個小時或以上 12 hours or more

2020年澳門市民體質監測數據登錄冊

Data Registration Manual of
2020 Physical Fitness Study of Macao SAR Residents

E4. 【單選題】在上學日(週一至週五)，你通常平均每天有多長時間花在看電視、使用手機/電腦/平板電腦等電子產品上？請在你選中的選項對應的序號上畫“○”。

【Single choice question】 On school days (Monday through Friday), what is the average daily time you spend watching TV and using electronic devices such as mobile/computers/laptop computers? Choose the proper answer and circle its corresponding number with “○”.

1	1~29分鐘 1-29 minutes	6	3個小時~不足4個小時 3 hours ~ less than 4 hours
2	30~59分鐘 30-59 minutes	7	4個小時~不足5個小時 4 hours ~ less than 5 hours
3	60分鐘-89分鐘 60-89 minutes	8	5個小時~不足6個小時 5 hours ~ less than 6 hours
4	90~119分鐘 90-119 minutes	9	6個小時或以上 6 hours or more
5	2個小時~不足3個小時 2 hours ~ less than 3 hours	10	一般沒有 Basically none

E5. 【單選題】在休息日(週六、週日或節假日)，你通常平均每天有多長時間花在看電視、使用手機/電腦/平板電腦等電子產品上？請在你選中的選項對應的序號上畫“○”。

【Single choice question】 On rest days (Saturdays, Sundays, or holidays), what is the average daily time you spend on watching TV and using electronic devices such as mobile/computers/laptop computers? Choose the proper answer and circle its corresponding number with “○”.

1	1~29分鐘 1-29 minutes	6	3個小時~不足4個小時 3 hours ~ less than 4 hours
2	30~59分鐘 30-59 minutes	7	4個小時~不足5個小時 4 hours ~ less than 5 hours
3	60分鐘-89分鐘 60-89 minutes	8	5個小時~不足6個小時 5 hours ~ less than 6 hours
4	90~119分鐘 90-119 minutes	9	6個小時或以上 6 hours or more
5	2個小時~不足3個小時 2 hours ~ less than 3 hours	10	一般沒有 Basically none

問卷完畢。謝謝。

This is the end of the questionnaire.
Thank you for participating.

兒童青少年（學生：6~22歲）- 小學四年級~小學六年級學生
Children and Adolescents (Students aged 6~22) - (Primary 4~6)

三. 檢測指標 (由監測人員在監測現場填寫)

Testing indicators (to be filled in by examiner on site)

1. 身高 (cm) Height (cm)	<input type="text"/> <input type="text"/> <input type="text"/> . <input type="text"/>
2. 坐高 (cm) Sitting height (cm)	<input type="text"/> <input type="text"/> . <input type="text"/>
3. 體重 (kg) Weight (kg)	<input type="text"/> <input type="text"/> <input type="text"/> . <input type="text"/>
4. 胸圍 (cm) Chest circumference (cm)	<input type="text"/> <input type="text"/> <input type="text"/> . <input type="text"/>
5. 腰圍 (cm) Waist circumference (cm)	<input type="text"/> <input type="text"/> <input type="text"/> . <input type="text"/>
6. 臀圍 (cm) Hip circumference (cm)	<input type="text"/> <input type="text"/> <input type="text"/> . <input type="text"/>
7. 體脂率 (%) Body fat percentage (%)	<input type="text"/> <input type="text"/> . <input type="text"/>
8. 肩寬 (cm) Shoulder width (cm)	<input type="text"/> <input type="text"/> . <input type="text"/>
9. 骨盆寬 (cm) Pelvis width (cm)	<input type="text"/> <input type="text"/> . <input type="text"/>
10. 足長 (cm) Foot length (cm)	<input type="text"/> <input type="text"/> . <input type="text"/>
11. 安靜脈搏 (次/分) Resting pulse (bpm)	<input type="text"/> <input type="text"/> <input type="text"/>
12. 收縮壓 (mmHg) Systolic blood pressure (mmHg)	<input type="text"/> <input type="text"/> <input type="text"/>
13. 舒張壓 (mmHg) Diastolic blood pressure (mmHg)	<input type="text"/> <input type="text"/> <input type="text"/>

2020年澳門市民體質監測數據登錄冊

Data Registration Manual of
2020 Physical Fitness Study of Macao SAR Residents

14.肺活量 (ml) Vital capacity (ml)	<input type="text"/> <input type="text"/> <input type="text"/> <input type="text"/>
15.斜身引體 (次) (6~12歲男) 引體向上 (次) (13~22歲男) 一分鐘仰臥起坐 (次) (6~22歲女) Inclined pull-ups (times) (6~12 years M) / Pull-ups (times) (13~22 years M) / One-minute sit-ups (times) (6~22 years F)	<input type="text"/> <input type="text"/> <input type="text"/>
16.立定跳遠 (cm) Standing long jump (cm)	<input type="text"/> <input type="text"/> <input type="text"/>
17.50米跑 (秒) 50m run (sec)	<input type="text"/> <input type="text"/> . <input type="text"/>
18.50×8往返跑 (秒) (6~12歲) / 800米跑 (秒) (13~22歲女) / 1000米跑 (秒) (13~22歲男) 50m×8 shuttle run (sec) (6~12 years) / 800m run (sec) (13~22 years F) / 1000m run (sec) (13~22 years M)	<input type="text"/> <input type="text"/> <input type="text"/> . <input type="text"/>
19.握力 (kg) Grip strength (kg)	<input type="text"/> <input type="text"/> . <input type="text"/>
20.縱跳 (cm) Vertical jump (cm)	<input type="text"/> <input type="text"/> . <input type="text"/>
21.背力 (kg) Back strength (kg)	<input type="text"/> <input type="text"/> <input type="text"/>
22.坐位體前屈 (cm) Sit and reach (cm)	<input type="text"/> <input type="text"/> <input type="text"/> . <input type="text"/>
23.閉眼單腳站立 (秒) One foot stands with eyes closed (OFSEC) (sec)	<input type="text"/> <input type="text"/> <input type="text"/>
24.選擇反應時 (秒) Choice reaction time (sec)	<input type="text"/> . <input type="text"/> <input type="text"/>

兒童青少年（學生：6~22歲） - 小學四年級~小學六年級學生
Children and Adolescents (Students aged 6~22) - (Primary 4~6)

25. 齲齒(6~18歲) Dental caries (6~18 years)	<table border="1" style="width: 100%; height: 20px; border-collapse: collapse;"> <tr> <td style="width: 12.5%;"></td><td style="width: 12.5%;"></td><td style="width: 12.5%;"></td><td style="width: 12.5%;"></td><td style="width: 12.5%;"></td><td style="width: 12.5%;"></td><td style="width: 12.5%;"></td><td style="width: 12.5%;"></td><td style="width: 12.5%;"></td><td style="width: 12.5%;"></td><td style="width: 12.5%;"></td><td style="width: 12.5%;"></td><td style="width: 12.5%;"></td><td style="width: 12.5%;"></td><td style="width: 12.5%;"></td><td style="width: 12.5%;"></td><td style="width: 12.5%;"></td><td style="width: 12.5%;"></td><td style="width: 12.5%;"></td><td style="width: 12.5%;"></td> </tr> </table> <p style="text-align: center; margin-top: 5px;"> d <input style="width: 20px; height: 20px;" type="text"/> D <input style="width: 20px; height: 20px;" type="text"/> m <input style="width: 20px; height: 20px;" type="text"/> M <input style="width: 20px; height: 20px;" type="text"/> f <input style="width: 20px; height: 20px;" type="text"/> F <input style="width: 20px; height: 20px;" type="text"/> </p>																				
26. 視力 Vision																					
裸眼視力 Naked eyes	<table style="width: 100%; border-collapse: collapse;"> <tr> <td style="width: 35%; text-align: center;">左 Left</td> <td style="width: 30%; border: 1px solid black; text-align: center;"> <input style="width: 20px; height: 20px;" type="text"/> <input style="width: 20px; height: 20px;" type="text"/> </td> <td style="width: 35%; text-align: center;">右 Right</td> <td style="width: 30%; border: 1px solid black; text-align: center;"> <input style="width: 20px; height: 20px;" type="text"/> <input style="width: 20px; height: 20px;" type="text"/> </td> </tr> </table>	左 Left	<input style="width: 20px; height: 20px;" type="text"/> <input style="width: 20px; height: 20px;" type="text"/>	右 Right	<input style="width: 20px; height: 20px;" type="text"/> <input style="width: 20px; height: 20px;" type="text"/>																
左 Left	<input style="width: 20px; height: 20px;" type="text"/> <input style="width: 20px; height: 20px;" type="text"/>	右 Right	<input style="width: 20px; height: 20px;" type="text"/> <input style="width: 20px; height: 20px;" type="text"/>																		
串鏡校正 Refractive error correction	<table style="width: 100%; border-collapse: collapse;"> <tr> <td style="width: 35%; text-align: center;">左 Left</td> <td style="width: 65%;"> 正片 Positive lens _____ 負片 Negative lens _____ </td> </tr> </table>	左 Left	正片 Positive lens _____ 負片 Negative lens _____																		
左 Left	正片 Positive lens _____ 負片 Negative lens _____																				
串鏡校正 Refractive error correction	<table style="width: 100%; border-collapse: collapse;"> <tr> <td style="width: 35%; text-align: center;">右 Right</td> <td style="width: 65%;"> 正片 Positive lens _____ 負片 Negative lens _____ </td> </tr> </table>	右 Right	正片 Positive lens _____ 負片 Negative lens _____																		
右 Right	正片 Positive lens _____ 負片 Negative lens _____																				
屈光不正 Refractive errors	<table style="width: 100%; border-collapse: collapse;"> <tr> <td style="width: 35%; text-align: center;">左 Left</td> <td style="width: 30%; border: 1px solid black; text-align: center;"> <input style="width: 20px; height: 20px;" type="text"/> </td> <td style="width: 35%; text-align: center;">右 Right</td> <td style="width: 30%; border: 1px solid black; text-align: center;"> <input style="width: 20px; height: 20px;" type="text"/> </td> </tr> <tr> <td style="text-align: center;">(0) 正常 Normal</td> <td style="text-align: center;">(1) 近視 Nearsighted</td> <td style="text-align: center;">(2) 遠視 Farsighted</td> <td style="text-align: center;">(3) 其他 Others</td> </tr> </table>	左 Left	<input style="width: 20px; height: 20px;" type="text"/>	右 Right	<input style="width: 20px; height: 20px;" type="text"/>	(0) 正常 Normal	(1) 近視 Nearsighted	(2) 遠視 Farsighted	(3) 其他 Others												
左 Left	<input style="width: 20px; height: 20px;" type="text"/>	右 Right	<input style="width: 20px; height: 20px;" type="text"/>																		
(0) 正常 Normal	(1) 近視 Nearsighted	(2) 遠視 Farsighted	(3) 其他 Others																		
27. 色覺檢查 Color vision deficiency exam																					
(1) 正常 Normal	(2) 不正常 Abnormal																				
<input style="width: 30px; height: 30px; border: 1px solid black;" type="checkbox"/>																					

檢驗員簽署：
Examiner Signature : _____

3. Secondary Students (Junior Secondary 1~Senior Secondary 3)

2020

澳門市民體質監測
Physical Fitness Study of Macao SAR Residents

數據登錄冊
Data Registration Manual

兒童青少年(學生：6~22歲)
Children and Adolescents
(Students aged 6~22)

(初中一年級~高中三年級學生)
(Junior Secondary 1 ~ Senior Secondary 3)

澳門特別行政區政府體育局
Sports Bureau, Macao SAR



歡迎閣下參加2020年澳門市民體質監測！澳門市民體質監測是特區政府為推動大眾健身活動的開展而進行的調查研究。在此首先感謝閣下對監測的支持並認真、如實地填寫問卷，我們保證對閣下的個人資料保密，有關資料不會獨立出現或使用，它將是整體數據的組成部分。再次對閣下的真誠參與表示感謝！

如對調查內容和檢測項目有任何疑問，歡迎向體育局運動醫學中心垂詢！

電話：28810896，88934540

Thank you for participating in our 2020 Physical Fitness Study! This study is organized by the Macao SAR Government to promote Sports for All. We are grateful for your participation. Your honesty and sincerity in filling out the questionnaire are appreciated. We promise to keep your personal data confidential and we will not publish or use your data individually. It will only be used as part of the whole study for statistical purposes. Again, we would like to extend our most sincere gratitude for your participation!

For any enquiries regarding the questionnaire or testing items, please feel free to contact Sports Medicine Centre of Macao Sports Bureau!
Telephone: 28810896, 88934540

2020年澳門市民體質監測數據登錄冊

Data Registration Manual of
2020 Physical Fitness Study of Macao SAR Residents

體育局轄下運動醫學中心預先聲明

Declaration
Sports Medicine Centre of Macao Sports Bureau

本聲明旨在向個人資料當事人或相關家長或監護人確保遵守第8/2005號法律“個人資料保護法”所規範的事宜。

This declaration is intended to assure data subjects or their parents or guardians that we will strictly comply with the relevant provisions of Act 8/2005 - Personal Data Protection Act.

1. 處理個人資料的負責人—體育局，地址設於澳門羅理基博士大馬路818號。代表—體育局局長。

Personal data controller: Macao Sports Bureau, at Av. Dr. Rodrigo Rodrigues, n.º 818, Macao.
Representative - President of Macao Sports Bureau.

2. 處理個人資料的目的—進行澳門市民體質監測，以便為制定日後關於體育及醫療護理的政策提供科學數據。收集的數據旨在更新僅為統計用途的數據庫。

Purposes of processing personal data: To conduct the physical fitness study for Macao residents, and provide scientific references for the development of relevant policies regarding sports and medical care. Data collected through the physical fitness study will only be used to update the database for statistical purposes.

3. 個人資料當事人類別—參與是次計劃的澳門居民（隨年齡抽樣）。

Categories of subjects with personal data: Macao residents participated in the study (random sampling by age).

4. 個人資料接收者—個人資料當事人（或相關家長或監護人），運動醫學中心及國家體育總局體育科學研究所。

Personal data recipients: Data subjects (or their parents or guardians), Sports Medicine Centre and China Institute of Sport Science.

5. 接收及處理個人資料的條件—個人資料當事人（或相關家長或監護人）享有第8/2005號法律賦予的所有權利如查閱權及更正所收集的個人資料。運動醫學中心承諾對不正確的數據進行更正，刪除或封鎖。

Conditions of receiving and processing personal data: Data subjects (or their parents or guardians) are entitled by Act 8/2005 - Personal Data Protection Act to the rights to access and rectify their own personal data collected. The Sports Medicine Centre hereby commits to take proper measures to rectify, delete or block any incorrect data.

兒童青少年（學生：6~22歲）- 初中一年級~高中三年級學生
Children and Adolescents (Students aged 6~22) - (Junior Secondary 1~Senior Secondary 3)

6.處理個人資料的安全和保密性—對處理及編輯個人資料絕對保密及採取適當措施以確保其安全。

Security and confidentiality of processing personal data: Appropriate measures are implemented to process and edit the personal data to ensure strict confidentiality, safety and security of the data.

本人已明白上述內容權益

I, the undersigned, am aware of the contents and my legal rights in the above declaration.

(個人資料當事人或家長或監護人簽名)
(Signature of subject providing personal
data/parents/guardian)

_____/_____/_____
(日) (月) (年)
(DD) (MM) (YY)

姓 名： Name:	_____
性 別： Gender:	_____
年 齡： Age:	_____ (周歲) (years)
就讀學校： School:	_____
聯繫電話： Phone:	_____

2020年澳門市民體質監測數據登錄冊

Data Registration Manual of
2020 Physical Fitness Study of Macao SAR Residents

一.分類編碼（學生個人資料，由家長協助填寫）

General Information (Personal information of student can be filled in by the parents)

填寫方法：

填寫選擇題時請將選擇答案的序號填入相應的方格中，如選答案（1），則在方格內填1；序號為兩位數時，兩位數字填入同一方格，如選項為（11），則將 填入同一方格，即填為 。在填寫多項選擇題時，如果僅選擇一個或兩個答案，則應在剩餘方格內填0。

Instructions for filling:

Please fill in the boxes with the corresponding numbers. For example, if the chosen answer is (1), fill in the box with "1". If the chosen option is a two digit number, write both digits in the same box. e.g. If the chosen option is (11), fill in the box with . For multiple choice questions, if only one or two option(s) were chosen, please fill in the remaining blank box(es) with "0".

1.澳門居民身份證號碼 Macao ID card number	<input type="text"/> <input type="text"/> <input type="text"/> <input type="text"/> <input type="text"/> <input type="text"/> <input type="text"/> <input type="text"/>		
2.性別 Gender	(1) 男 Male	(2) 女 Female	<input type="text"/>
3.出生日期 Date of birth	<input type="text"/> <input type="text"/> <input type="text"/> <input type="text"/> 年 Y	<input type="text"/> <input type="text"/> 月 M	<input type="text"/> <input type="text"/> 日 D
4.測試日期（由監測人員填寫） Examination date (to be filled in by examiner)	<input type="text"/> <input type="text"/> <input type="text"/> <input type="text"/> 年 Y	<input type="text"/> <input type="text"/> 月 M	<input type="text"/> <input type="text"/> 日 D
5.學校代碼（由監測人員填寫） School code number (filled in by examiner)	<input type="text"/> <input type="text"/> <input type="text"/> <input type="text"/>		
6.測試序號（由監測人員填寫） Serial number (filled in by examiner)	<input type="text"/> <input type="text"/> <input type="text"/> <input type="text"/>		
7.居住在澳門的年限（年）（指連續在澳門居住的年限，如果離開澳門的時間超過1年，則要由回澳門居住起重新計算居澳年限） Years of residence in Macao (It refers to years of continuous residence in Macao. If you had left Macao for over 1 year, years of residence in Macao should be recalculated from the time of returning to Macao.)	<input type="text"/> <input type="text"/>		

兒童青少年（學生：6~22歲）- 初中一年級~高中三年級學生
Children and Adolescents (Students aged 6~22) - (Junior Secondary 1~Senior Secondary 3)

<p>8. 在學校就讀年級 School grade</p> <p>(1) 初中一年級 Junior Secondary 1</p> <p>(2) 初中二年級 Junior Secondary 2</p> <p>(3) 初中三年級 Junior Secondary 3</p> <p>(4) 高中一年級 Senior Secondary 1</p> <p>(5) 高中二年級 Senior Secondary 2</p> <p>(6) 高中三年級 Senior Secondary 3</p>	<input type="checkbox"/>
<p>9. 出生地 Place of birth</p> <p>(1) 中國大陸 Mainland China</p> <p>(2) 澳門 Macao</p> <p>(3) 香港 Hong Kong</p> <p>(4) 葡萄牙 Portugal</p> <p>(5) 其他 Others</p>	<input type="checkbox"/>
<p>10. 居住地所屬堂區 Parish of residence</p> <p>(1) 聖方濟各堂區（路環） Paróquia de São Francisco Xavier (Coloane)</p> <p>(2) 聖嘉模堂區（氹仔） Paróquia de Nossa Senhora do Carmo (Taipa)</p> <p>(3) 風順堂區（包括媽閣山、西望洋山、下環及內港一帶） Paróquia de S. Lourenço (Zonas das Colinas da Barra e da Penha, da Praia do Manduco e do Porto Interior)</p> <p>(4) 大堂區（新馬路一帶、南灣、水坑尾、新口岸南北地段及南灣湖發展區） Paróquia da Sé Catedral (Zonas da Almeida Ribeiro, da Praia Grande, da Rua do Campo, dos Lotes norte e sul do Porto Exterior e da Zona do Lago Nam Van)</p> <p>(5) 花王堂區（聖安多尼堂區，在澳門西部，包括高士德大馬路、新橋和沙梨頭） Paróquia de Santo António (Zonas da Freguesia de Santo António, do Oeste de Macau, incluindo Av. Horta e Costa, de San Kiu e do Patane)</p> <p>(6) 望德堂區（包括荷蘭園、松山一帶） Paróquia de S. Lázaro (Zona do Conselheiro Ferreira de Almeida e da Colina da Guia)</p> <p>(7) 花地瑪堂區（俗稱北區，包括青洲、台山、黑沙環、筷子基和水塘） Paróquia de Nossa Senhora de Fátima (Zonas do Norte, incluindo Ilha Verde, Tamagnini Barbosa, Areia Preta, Fái Chi Kei e Reservatório)</p>	<input type="checkbox"/>
<p>11. 近5年曾患過何種疾病（經醫院確診的疾病）（選擇“無”者請直接回答問題第13題） Any hospital-diagnosed diseases suffered within the past 5 years? (If the answer is “no”, skip to Question 13)</p> <p>(1) 有 Yes</p> <p>(2) 無 No</p>	<input type="checkbox"/>

2020年澳門市民體質監測數據登錄冊

Data Registration Manual of
2020 Physical Fitness Study of Macao SAR Residents

12.患病種類 (患病者按主次順序, 最多可填寫3項) Diseases suffered (in order of precedence, choose up to 3 diseases)			<input type="text"/>	<input type="text"/>	<input type="text"/>
(1) 氣管炎 Tracheitis	(2) 肺炎 Pneumonia	(3) 哮喘 Asthma			
(4) 過敏性鼻炎 Allergic rhinitis	(5) 腹瀉病 Diarrhea	(6) 腸胃炎 Gastroenteritis			
(7) 腎炎 Nephritis	(8) 維生素缺乏症 Avitaminosis	(9) 扁桃腺炎 Tonsillitis			
(10) 肝炎 Hepatitis	(11) 肺結核 Tuberculosis	(12) 水痘 Varicella			
(13) 脊柱彎曲異常 Scoliosis	(14) 流行性腮腺炎 Mumps	(15) 高血壓 Hypertension			
(16) 貧血 Anemia	(17) 心臟病 Heart disease	(18) 糖尿病 Diabetes			
(19) 低血糖 Hypoglycemia	(20) 意外傷害(造成人體的損傷而 需要醫治或影響了正常的活動) Accidental injury (injury to the body that needs treatments, or injury that affects normal activities)	(21) 其他 Others			
13.有沒有每天刷牙習慣 Do you brush your teeth every day?			<input type="checkbox"/>		
(1) 有 Yes	(2) 無 No				
14.除刷牙外, 有沒有每天使用牙線 Do you use dental floss in addition to tooth-brushing every day?			<input type="checkbox"/>		
(1) 有 Yes	(2) 無 No				
15.過去12個月有沒有到牙醫診所進行牙科檢查 Did you go to a dental clinic for dental examination within the past 12 months?			<input type="checkbox"/>		
(1) 有 Yes	(2) 無 No				
16.是否有齲齒 (選擇“無”或“不知道”者請直接回答問題第18題) Do you have any decayed tooth? (If the answer is “no” or “don’t know”, skip to Question 18)			<input type="checkbox"/>		
(1) 有 Yes	(2) 無 No	(3) 不知道 Don't know			

兒童青少年（學生：6~22歲）- 初中一年級~高中三年級學生
Children and Adolescents (Students aged 6~22) - (Junior Secondary 1~Senior Secondary 3)

<p>17. 如有齲齒，有沒有到牙醫診所進行治療？ If yes, have you visited a dental clinic for treatment?</p> <p>(1) 有 (2) 無 Yes No</p>	<input type="checkbox"/>
<p>18. 是否有親兄弟姐妹？ Do you have any siblings?</p> <p>(1) 沒有 (2) 有1個 (3) 有2個或以上 No 1 2 or more</p>	<input type="checkbox"/>
<p>19. 是否有影響開展體育活動的先天性疾病或者殘疾？ Do you have any congenital disease or disability that affects physical activity?</p> <p>(1) 沒有 (2) 有（請注明 _____） No Yes (Please specify _____)</p>	<input type="checkbox"/>
<p>20. 是否與父母住在一起共同生活？ Do you live with your parents?</p> <p>(1) 是 (2) 否 (3) 只與父或母任一方同住 Yes No Live with one of my parents</p>	<input type="checkbox"/>

2020年澳門市民體質監測數據登錄冊

Data Registration Manual of
2020 Physical Fitness Study of Macao SAR Residents

二. 健身素養問卷(由學生獨立回答)

Fitness Literacy (to be answered by student independently)

A-健身知識 Fitness knowledge

A1. 【單選題】你認為以下說法是否正確，正確選1、不正確選2、不知道選3，並在你選的數字上畫“○”。

[Single choice question] Which of the following descriptions do you think are correct? Choose 1 for “Correct”, 2 for “Incorrect”, 3 for “Don’t know”, and circle each corresponding number with “○”.

題目 Question	正確 Correct	不正確 Incorrect	不知道 Don't know
1) 貧血患者應該多參加體育鍛煉 Anemia patients should do more physical exercises.	1	2	3
2) 每次游泳前都應該做準備活動 Warm up before swimming each time.	1	2	3
3) 劇烈運動時，只能用鼻子呼吸 During strenuous exercise, you should only breathe through the nose.	1	2	3
4) 身體消瘦者宜選擇增強肌肉力量的運動，如俯臥撐、單雙杠、舉啞鈴等 Skinny person should choose exercises targeted to improve muscle strength, such as push-ups, horizontal and parallel bars, lifting dumbbells, etc.	1	2	3
5) 彎道跑時，身體要向跑道內傾斜 When running round the bend, you should incline your body to the inside of the track.	1	2	3
6) 冬季奧運會每四年舉行一次 The Winter Olympics are held once every four years.	1	2	3
7) 騎自行車是無氧運動 Cycling is an anaerobic exercise.	1	2	3
8) 急行跳遠起跳時需兩腳用前腳掌迅猛蹬地，身體向上騰起 To complete a long jump, you should push both balls of your feet off the ground vigorously to push your body up.	1	2	3
9) 站立體前屈是徒手練習坐位體前屈的方法，需要兩腿並立，膝蓋伸直，上體前屈，兩手掌觸地，上體與腿盡量貼近 Standing forward bend is a body weight training to practice sit and reach, in which you have to keep both legs standing together with straight knees, and bend forward the upper body with both palms touch the ground and keep the upper body close to legs as much as possible.	1	2	3
10) 原地高抬腿運動的節奏要快，身體需要微微向後傾 To do a high-knee running in place, you should keep a fast pace and lean back the body slightly.	1	2	3

兒童青少年（學生：6~22歲）- 初中一年級~高中三年級學生
Children and Adolescents (Students aged 6-22) - (Junior Secondary 1~Senior Secondary 3)

B-健身態度 Fitness attitude

B1. 【單選題】 以下說法你是否同意，非常不同意選1、不太同意選2、一般選3、比較同意選4、非常同意選5，並在你選的數字上畫“○”。

【Single choice question】 Which of the following descriptions do you agree with? Choose 1 for “Strongly disagree”, 2 for “Slightly disagree”, 3 for “Neutral”, 4 for “Relatively agree”, 5 for “Strongly agree”, and circle each corresponding number with “○”.

題目 Question	非常不同意 Strongly disagree	不太同意 Slightly disagree	一般 Neutral	比較同意 Relatively agree	非常同意 Strongly agree
1) 體育鍛煉可以強身健體 Doing physical exercise can strengthen our body.	1	2	3	4	5
2) 體育鍛煉可以減肥 Doing physical exercise can help us lose weight.	1	2	3	4	5
3) 體育鍛煉有助於增強自信心 Doing physical exercise can improve self-confidence.	1	2	3	4	5
4) 體育鍛煉能夠讓自己交到更多朋友 Doing physical exercise can help us to meet more friends.	1	2	3	4	5
5) 體育鍛煉可以錘煉意志 Doing physical exercise can temper your willpower.	1	2	3	4	5

B2. 【單選題】 以下說法是否符合你的真實情況?非常不符合選1、不太符合選2、一般選3、比較符合選4、非常符合選5，並在你選的數字上畫“○”。

【Single choice question】 Which of the following descriptions is consistent with your situation? Choose 1 for “Very inconsistent”, 2 for “Not quite consistent”, 3 for “Neutral”, 4 for “Slightly consistent”, 5 for “Very consistent”, and circle each corresponding number with “○”.

題目 Question	非常不符合 Very inconsistent	不太符合 Not quite consistent	一般 Neutral	比較符合 Slightly consistent	非常符合 Very consistent
6) 體育鍛煉非常有用 Doing physical exercises is very useful.	1	2	3	4	5
7) 體育鍛煉非常無聊，浪費時間 Doing physical exercise is very boring and it is just a waste of time.	1	2	3	4	5
8) 體育鍛煉容易使人受傷 Doing physical exercise may cause injuries.	1	2	3	4	5
9) 體育鍛煉的體驗不是很愉快 The experience of exercising is not pleasant	1	2	3	4	5
10) 體育鍛煉過後會很累，影響做其他事情 I'll be too tired to do other things after exercising.	1	2	3	4	5

2020年澳門市民體質監測數據登錄冊

Data Registration Manual of
2020 Physical Fitness Study of Macao SAR Residents

B3. 【單選題】以下說法是否符合你的真實情況?非常不符合選1、不太符合選2、一般選3、比較符合選4、非常符合選5，並在你選的數字上畫“○”。

【Single choice question】 Which of the following descriptions is consistent with your situation? Choose 1 for “Very inconsistent”, 2 for “Not quite consistent”, 3 for “Neutral”, 4 for “Slightly consistent”, 5 for “Very consistent”, and circle each corresponding number with “○”.

題目 Question	非常不符合 Very inconsistent	不太符合 Not quite consistent	一般 Neutral	比較符合 Slightly consistent	非常符合 Very consistent
11) 體育課上老師教的體育技能，比較難掌握 It is difficult for me to learn the sport skills taught in PE class.	1	2	3	4	5
12) 父母或對我很重要的人（比如爺爺、奶奶、同學、朋友、老師等）經常督促進行體育鍛煉 My parents or those who are important to me (such as grandpa, grandma, classmates, friends and teachers) often encourage me to do physical exercise.	1	2	3	4	5
13) 如果我願意，體育鍛煉要求的各項指標我都可以達標 I can meet all the required indicators of physical exercises if I want to.	1	2	3	4	5
14) 如果我願意，可以一直堅持進行體育鍛煉 I can keep on exercising if I want to.	1	2	3	4	5
15) 我認為自己已經掌握的體育鍛煉技能是正確的、科學的 I think the sport skills that I acquired are correct and scientific.	1	2	3	4	5

兒童青少年（學生：6~22歲）- 初中一年級~高中三年級學生
Children and Adolescents (Students aged 6-22) - (Junior Secondary 1~Senior Secondary 3)

B4. 【單選題】以下說法是否符合你的真實情況？非常不符合選1、不太符合選2、一般選3、比較符合選4、非常符合選5，並在你選的數字上畫“○”。

【Single choice question】 Which of the following descriptions is consistent with your situation? Choose 1 for “Very inconsistent”, 2 for “Not quite consistent”, 3 for “Neutral”, 4 for “Slightly consistent”, 5 for “Very consistent”, and circle each corresponding number with “○”.

題目 Question	非常不符合 Very inconsistent	不太符合 Not quite consistent	一般 Neutral	比較符合 Slightly consistent	非常符合 Very consistent
16) 會受其他同學的帶動去參加體育鍛煉 I'll follow my classmates to do some physical exercise.	1	2	3	4	5
17) 已經有了堅持進行體育鍛煉的想法 I have already made up my mind to keep on exercising.	1	2	3	4	5
18) 已經或正準備制定一份體育鍛煉的大致計劃 (包括想法) I have prepared or am preparing a rough plan for physical exercise.	1	2	3	4	5
19) 已經或正準備去瞭解、諮詢一下體育健身的專業人士（如體育老師、健身教練、電視節目），聽一下他們的專業意見 I have visited or am planning to consult with sports and fitness professionals (e.g., PE teachers, fitness coaches, TV shows) and get their professional advice.	1	2	3	4	5

2020年澳門市民體質監測數據登錄冊

Data Registration Manual of
2020 Physical Fitness Study of Macao SAR Residents

C-健身技能 Fitness skills

C1. 【多選題】你嘗試過的運動項目有哪些？本題為多選題，可選1個或1個以上的答案，請圈選所有你參與過的運動項目，在選項對應的序號上畫“○”。

[Multiple choice question] What kind of physical exercises have you tried? This is a multiple choice question. You need to choose at least 1 option. Choose all the physical exercises in which you have ever participated, and circle each corresponding number with “○”.

1	健步走 Brisk walking	13	騎自行車 Cycling	25	水球 Water polo
2	中短程跑(1500米內) Short- and middle-distance running(<1,500m)	14	羽毛球 Badminton	26	柔道 Judo
3	長跑(距離超過1500米) Long-distance running (>1,500m)	15	網球 Tennis	27	滑冰 Skating
4	跳高 High jump	16	體操 Gymnastics	28	滑雪 Skiing
5	跳遠 Long jump	17	韻律操(形體操、健美操、體育舞蹈、舞蹈等) Rhythmic gymnastics (such as gym, aerobics, sport dance, dance, etc.)	29	跳繩 Rope skipping
6	籃球 Basketball	18	游泳 Swimming	30	踢毽子 Shuttlecock kicking
7	排球(包括沙灘排球) Volleyball (including beach volleyball)	19	武術 Martial arts	31	輪滑 Roller skating
8	足球 Football	20	跆拳道 Taekwondo	32	冰球 Ice hockey
9	乒乓球 Table tennis	21	空手道 Karate	33	舉重 Weight-lifting
10	高爾夫球 Golf	22	曲棍球 Hockey	34	標槍 Javelin
11	棒球 Baseball	23	擊劍 Fencing	35	其他 Others
12	鉛球(包括實心球) Shot-put (including solid ball)	24	跨欄 Hurdles	36	沒有參加過任何運動項目 (不用回答C2題) None (skip Question C2)

兒童青少年（學生：6~22歲）- 初中一年級~高中三年級學生
Children and Adolescents (Students aged 6-22) - (Junior Secondary 1~Senior Secondary 3)

C2. 【多選題】你能夠熟練掌握的運動項目有哪些（熟練是指自己能掌握某項運動的基本技能和基本比賽規則）？本題為多選題，可選1個或1個以上的答案，請圈選所有你熟練掌握的運動項目，在選項對應的序號上畫“○”。

【Multiple choice question】What kind of physical exercises are you proficient in (Proficiency means that you have perfectly acquired the basic skills and competition rules of a physical exercise)? This is a multiple choice question. You need to choose at least 1 option. Choose all the physical exercises in which you are proficient, and circle each corresponding number with “○”.

1	健步走 Brisk walking	13	騎自行車 Cycling	25	水球 Water polo
2	中短程跑(1500米內) Short- and middle-distance running(<1,500m)	14	羽毛球 Badminton	26	柔道 Judo
3	長跑(距離超過1500米) Long-distance running (>1,500m)	15	網球 Tennis	27	滑冰 Skating
4	跳高 High jump	16	體操 Gymnastics	28	滑雪 Skiing
5	跳遠 Long jump	17	韻律操（形體操、健美操、體育舞蹈、舞蹈等） Rhythmic gymnastics (such as gym, aerobics, sport dance, dance, etc.)	29	跳繩 Rope skipping
6	籃球 Basketball	18	游泳 Swimming	30	踢毽子 Shuttlecock kicking
7	排球(包括沙灘排球) Volleyball (including beach volleyball)	19	武術 Martial arts	31	輪滑 Roller skating
8	足球 Football	20	跆拳道 Taekwondo	32	冰球 Ice hockey
9	乒乓球 Table tennis	21	空手道 Karate	33	舉重 Weight-lifting
10	高爾夫球 Golf	22	曲棍球 Hockey	34	標槍 Javelin
11	棒球 Baseball	23	擊劍 Fencing	35	其他 Others
12	鉛球(包括實心球) Shot-put (including solid ball)	24	跨欄 Hurdles	36	沒有熟練掌握的運動項目 None

2020年澳門市民體質監測數據登錄冊

Data Registration Manual of
2020 Physical Fitness Study of Macao SAR Residents

C3. 【多選題】 你能夠熟練掌握的準備活動有哪些（熟練是指自己獨立會做某項準備活動）？本題為多選題，可選1個或1個以上的答案，請圈選所有你熟練掌握的準備活動，在選項對應的序號上畫“○”。如果沒有熟練掌握的準備活動只圈選10即可。

【Multiple choice question】 What kind of warm-up exercises are you proficient in (Proficiency means that you can do a warm-up exercise on your own)? This is a multiple choice question. You need to choose at least 1 option. Choose all the warm-up exercises in which you are proficient, and circle the corresponding number with “○”. If the answer is none, circle the number 10.

1 慢跑 Jogging	6 壓腿（包括前壓腿和側壓腿） Leg stretch (including forward lunge stretch and side lunge stretch)
2 腰部運動（如扭腰） Waist movement (such as waist twisting)	7 體前屈 Forward bend
3 肩部運動（轉動肩膀） Shoulder movement (rolling shoulders)	8 原地高抬腿 High-knee running in place
4 關節活動（包括手腕關節、頸關節和腳踝關節） Joint movement (including wrist, neck and ankle joints)	9 其他 Others
5 擴胸運動 Chest expansion exercise	10 沒有熟練掌握的準備活動 None

C4. 【多選題】 你知道以下哪些運動損傷的正確處理方法？本題為多選題，可選1個或1個以上的答案，請圈選所有你會處理的運動損傷情況，在選項對應的序號上畫“○”。

【Multiple choice question】 Which of the following exercise injuries can you handle correctly? This is a multiple choice question. You need to choose at least 1 option. Choose all the exercise injuries you can handle correctly, and circle each corresponding number with “○”.

1 擦傷（如膝蓋擦傷） Abrasion (such as skinned knee)	5 中暑 Heatstroke
2 肌肉拉傷（如大腿拉傷） Pulled muscle (such as thigh strain)	6 運動腹痛（如肚子疼） Exercise abdominal pain (such as tummy ache)
3 運動扭傷（如腰扭傷） Sprains (such as lumbar sprain)	7 其他 Others
4 抽筋（如小腿抽筋） Cramps (such as calf cramp)	8 不知道任何運動損傷的正確處理方法 None

兒童青少年（學生：6~22歲）- 初中一年級~高中三年級學生
Children and Adolescents (Students aged 6~22) - (Junior Secondary 1~Senior Secondary 3)

C5. 【單選題】在體育鍛煉中膝蓋擦傷了，最好應該怎麼處理？請在你選中的選項對應的序號上畫“○”。

【Single choice question】 If the knee is skinned during exercise, what is the best way to handle it? Choose the proper answer and circle its corresponding number with “○”.

1	立即用酒精消毒 Disinfect the wound with alcohol immediately.
2	清水沖洗一下即可 Just rinse the wound with water.
3	清洗後用酒精消毒 Clean the would first, and then disinfect it with alcohol.
4	其他 Others
5	不知道 Don't know

C6. 【多選題】你認為以下哪些渠道可以獲取比較科學、專業的體育健身資訊？本題為多選題，可選1個或1個以上的答案，請圈選所有你可以獲取的渠道，在選項對應的序號上畫“○”。

【Multiple choice question】 Which of the following ways do you think you can access more scientific and professional sports and fitness information? This is a multiple choice question. You need to choose at least 1 option. Choose all the proper ways, and circle each corresponding number with “○”.

1	學校體育老師 PE teachers	4	互聯網 Internet	7	新聞 News
2	影視明星 Movie stars	5	廣告 Advertisement	8	父母、同學、朋友 Parents, classmates, friends
3	體育健身俱樂部 Fitness clubs	6	書本 Books	9	不知道 Don't know

2020年澳門市民體質監測數據登錄冊

Data Registration Manual of
2020 Physical Fitness Study of Macao SAR Residents

D-健身習慣 Fitness habits

D1. 【單選題】本學期你平均每週會有多少次上體育課？請在你選中的選項對應的序號上畫“○”（當兩堂體育課是連著一起上時，也只記為1次；如果不是連著上就記為2次）。

【Single choice question】 How many PE classes do you take in a typical week this semester? Choose the proper answer and circle its corresponding number with “○”. (If two PE classes are arranged consecutively, count as one; if not, count as two.)

1	1次 1 time	4	4次 4 times
2	2次 2 times	5	5次或以上 5 times or more
3	3次 3 times	6	0次(不用回答D2、D3題) 0 time (skip Questions D2, D3)

D2. 【單選題】你每次上體育課的時間大概是多長？請在你選中的選項對應的序號上畫“○”。

【Single choice question】 How long is each PE class you take? Choose the proper answer and circle its corresponding number with “○”.

1	不足30分鐘 Less than 30 minutes	3	60-89分鐘 60-89 minutes
2	30-59分鐘 30-59 minutes	4	90分鐘或以上 90 minutes or more

D3. 【單選題】多數情況下，你上體育課進行體育活動或鍛煉時的身體感受是甚麼樣的？在你選中的選項對應的序號上畫“○”。

【Single choice question】 Generally speaking, how do you feel physically when exercising in PE class? Choose the proper answer and circle its corresponding number with “○”.

1	呼吸平穩、和平常差不多、 沒有特別感覺 Breathing and heart rate remaining the same as usual	2	微微出汗、呼吸加快、心跳 有點快 Slight sweating with slightly increased breathing & heart rate	3	出汗較多、心跳明顯加快、 上氣不接下氣 Increased sweating with significantly increased breathing & heart rate
---	---	---	---	---	--

兒童青少年（學生：6~22歲）- 初中一年級~高中三年級學生
Children and Adolescents (Students aged 6~22) - (Junior Secondary 1~Senior Secondary 3)

D4. 【單選題】除學校體育課外，最近1個月，你平均每週會有多少次參加體育鍛煉（包括課外體育活動和校外體育鍛煉）？請在你選中的選項對應的序號上畫“○”。

【Single choice question】In addition to PE classes in school, what is your average frequency of exercising (including extracurricular exercise and after-school exercise) in a typical week in the recent month? Choose the proper answer and circle its corresponding number with “○”.

1	平均每週7次或以上 7 times or more on average per week	5	平均每週3次 3 times on average per week
2	平均每週6次 6 times on average per week	6	平均每週2次 2 times on average per week
3	平均每週5次 5 times on average per week	7	平均每週1次 1 time on average per week
4	平均每週4次 4 times on average per week	8	0次(不用回答D5、D6題) 0 time (skip Questions D5, D6)

D5. 【單選題】除學校體育課外，多數情況下，你每次進行體育活動或鍛煉(比如課外體育活動、校外體育鍛煉)的持續時間大概是多長？請在你選中的選項對應的序號上畫“○”。

【Single choice question】Generally speaking, what is your average duration of exercising (such as extracurricular exercise and after-school exercise) each time, in addition to PE class in school? Choose the proper answer and circle its corresponding number with “○”.

1	不足30分鐘 Less than 30 minutes	3	60-89分鐘 60-89 minutes
2	30-59分鐘 30-59 minutes	4	90分鐘或以上 90 minutes or more

2020年澳門市民體質監測數據登錄冊

Data Registration Manual of
2020 Physical Fitness Study of Macao SAR Residents

D6. 【單選題】除學校體育課外，多數情況下，你進行體育活動或鍛煉(比如課外體育活動、校外體育鍛煉)時的身體感受是甚麼樣的？請在你選中的選項對應的序號上畫“○”。

【Single choice question】Generally speaking, how do you feel physically when exercising (such as extracurricular exercise and after-school exercise), in addition to PE class in school? Choose the proper answer and circle its corresponding number with “○”.

1	呼吸平穩、和平常差不多、沒有特別感覺 Breathing and heart rate remaining the same as usual	2	微微出汗、呼吸加快、心跳有點快 Slight sweating with slightly increased breathing & heart rate	3	出汗較多、心跳明顯加快、上氣不接下氣 Increased sweating with significantly increased breathing & heart rate
---	--	---	---	---	--

D7. 【單選題】你通常每週有幾天進行力量練習(包括俯臥撐、仰臥起坐、引體向上、深蹲等徒手練習或使用啞鈴、彈力帶等健身器械的練習)？請在你選中的選項對應的序號上畫“○”。

【Single choice question】How many days in a week do you usually do strength exercises (including bodyweight training such as push-ups, sit-ups, pull-ups, and squats; or equipment workout such as using dumbbells and elastic bands)? Choose the proper answer and circle its corresponding number with “○”.

1	1天 1 day	3	3天 3 days	5	5天 5 days	7	7天 7 days
2	2天 2 days	4	4天 4 days	6	6天 6 days	8	0天 0 day

兒童青少年（學生：6~22歲）- 初中一年級~高中三年級學生
Children and Adolescents (Students aged 6~22) - (Junior Secondary 1~Senior Secondary 3)

D8. 【多選題】最近一年，你一直在持續做哪些體育鍛煉（包括體育課、課外體育活動和校外體育鍛煉）？本題為多選題，可選1個或1個以上的答案，請圈選你一直在持續做的所有體育鍛煉，在選項對應的序號上畫“○”。

【Multiple choice question】 What kind of physical exercises have you been doing consistently in the recent year (including PE class, extracurricular exercise and after-school exercise)? This is a multiple choice question. You need to choose at least 1 option. Choose all the physical exercises you have been doing, and circle each corresponding number with “○”.

1	健步走 Brisk walking	13	騎自行車 Cycling	25	水球 Water polo
2	中短程跑(1500米內) Short- and middle-distance running(<1,500m)	14	羽毛球 Badminton	26	柔道 Judo
3	長跑(距離超過1500米) Long-distance running (>1,500m)	15	網球 Tennis	27	滑冰 Skating
4	跳高 High jump	16	體操 Gymnastics	28	滑雪 Skiing
5	跳遠 Long jump	17	韻律操（形體操、健美操、體育舞蹈、舞蹈等） Rhythmic gymnastics (such as gym, aerobics, sport dance, dance, etc.)	29	跳繩 Rope skipping
6	籃球 Basketball	18	游泳 Swimming	30	踢毽子 Shuttlecock kicking
7	排球(包括沙灘排球) Volleyball (including beach volleyball)	19	武術 Martial arts	31	輪滑 Roller skating
8	足球 Football	20	跆拳道 Taekwondo	32	冰球 Ice hockey
9	乒乓球 Table tennis	21	空手道 Karate	33	舉重 Weight-lifting
10	高爾夫球 Golf	22	曲棍球 Hockey	34	標槍 Javelin
11	棒球 Baseball	23	擊劍 Fencing	35	其他 Others
12	鉛球(包括實心球) Shot-put (including solid ball)	24	跨欄 Hurdles	36	沒有持續做的體育鍛煉項目 (不用回答D9、D10、D11題) None (skip Questions D9, D10, D11)

2020年澳門市民體質監測數據登錄冊

Data Registration Manual of
2020 Physical Fitness Study of Macao SAR Residents

D9. 【單選題】按上述D8題中選擇的這些體育鍛煉項目，以持續鍛煉最久的項目為主，你大概堅持做了多長時間？請在你選中的選項對應的序號上畫“○”。

【Single choice question】 Among the physical exercises chosen in the above Question D8, taking the one with the longest duration as an example, how long have you been doing it? Choose the proper answer and circle its corresponding number with “○”.

1	沒有 N/A	3	1個月或以上，但不足3個月 1 month or more, but less than 3 months	5	半年或以上，但不足1年 Half a year or more, but less than 1 year
2	不足1個月 Less than 1 month	4	3個月或以上，但不足半年 3 months or more, but less than half a year	6	1年或以上 1 year or more

D10. 【單選題】按上述D8題中選擇的這些體育鍛煉項目，你一直堅持做的主要原因是甚麼？請在你選中的選項對應的序號上畫“○”。

【Single choice question】 Among the physical exercises chosen in the above Question D8, what is the main reason that keeps you in doing these? Choose the proper answer and circle its corresponding number with “○”.

1	學校或老師要求 Required by school or teachers	3	自己喜歡 Personal preference	5	其他 Others
2	家長要求 Required by my parents	4	體育考試或測驗需要 Required in PE exams or tests	6	不知道 Don't know

D11. 【單選題】你是如何選中D8題中的這些體育鍛煉項目的？請在你選中的選項對應的序號上畫“○”。

【Single choice question】 How did you choose the physical exercises chosen in Question D8? Choose the proper answer and circle its corresponding number with “○”.

1	自己隨便選的 I chose them randomly.	3	跟著學校的要求做的 I chose them as required by school.	5	哪些項目容易就選哪些 I chose them because they are easy to do.
2	哪些項目練起來方便就選哪些 I chose them because they are convenient to do.	4	跟著家人、朋友或同學等選的 I followed the choices of my family members, friends or schoolmates.	6	諮詢過專業意見 I chose them after seeking for professional advice.

兒童青少年（學生：6~22歲）- 初中一年級~高中三年級學生
Children and Adolescents (Students aged 6~22) - (Junior Secondary 1~Senior Secondary 3)

E-其他習慣 Other habits

E1. 【填空题】你通常每天有多少時間坐著或者靠著(包括坐著上文化課、做功課、看電視、使用電腦、吃飯、乘車等等坐著的時間)

【Blank-filling question】 What is your average sitting or reclining time (including the sitting time for school classes, homework, watching TV, using computers, eating, and transportation, etc.) per day?

請填寫： 小時 分鐘。
Please fill in the blanks: hours minutes

E2. 【單選題】在上學日(週一至週五)，你通常平均每天睡眠時長是多少(含午休)？

【Single choice question】 On school days (Monday through Friday), what is your average sleep time (including naps) per day?

1	8個小時以下 Less than 8 hours	4	10個小時至不足11個小時 10 hours ~ less than 11 hours
2	8個小時至不足9個小時 8 hours ~ less than 9 hours	5	11個小時至不足12個小時 11 hours ~ less than 12 hours
3	9個小時至不足10個小時 9 hours ~ less than 10 hours	6	12個小時或以上 12 hours or more

E3. 【單選題】在休息日(週六、週日或節假日)，你通常平均每天睡眠時長是多少(含午休)？

【Single choice question】 On rest days (Saturdays, Sundays, or holidays), what is your average sleep time (including naps) per day?

1	8個小時以下 Less than 8 hours	4	10個小時至不足11個小時 10 hours ~ less than 11 hours
2	8個小時至不足9個小時 8 hours ~ less than 9 hours	5	11個小時至不足12個小時 11 hours ~ less than 12 hours
3	9個小時至不足10個小時 9 hours ~ less than 10 hours	6	12個小時或以上 12 hours or more

2020年澳門市民體質監測數據登錄冊

Data Registration Manual of
2020 Physical Fitness Study of Macao SAR Residents

E4. 【單選題】在上學日(週一至週五)，你通常平均每天有多長時間花在看電視、使用手機/電腦/平板電腦等電子產品上？請在你選中的選項對應的序號上畫“○”。

【Single choice question】 On school days (Monday through Friday), what is the average daily time you spent watching TV and using electronic devices such as mobile/computers/laptop computers? Choose the proper answer and circle its corresponding number with “○”.

1	1~29分鐘 1-29 minutes	6	3個小時~不足4個小時 3 hours ~ less than 4 hours
2	30~59分鐘 30-59 minutes	7	4個小時~不足5個小時 4 hours ~ less than 5 hours
3	60分鐘-89分鐘 60-89 minutes	8	5個小時~不足6個小時 5 hours ~ less than 6 hours
4	90~119分鐘 90-119 minutes	9	6個小時或以上 6 hours or more
5	2個小時~不足3個小時 2 hours ~ less than 3 hours	10	一般沒有 Basically none

E5. 【單選題】在休息日(週六、週日或節假日)，你通常平均每天有多長時間花在看電視、使用手機/電腦/平板電腦等電子產品上？請在你選中的選項對應的序號上畫“○”。

【Single choice question】 On rest days (Saturdays, Sundays, or holidays), what is the average daily time you spend on watching TV and using electronic devices such as mobile/computers/laptop computers? Choose the proper answer and circle its corresponding number with “○”.

1	1~29分鐘 1-29 minutes	6	3個小時~不足4個小時 3 hours ~ less than 4 hours
2	30~59分鐘 30-59 minutes	7	4個小時~不足5個小時 4 hours ~ less than 5 hours
3	60分鐘-89分鐘 60-89 minutes	8	5個小時~不足6個小時 5 hours ~ less than 6 hours
4	90~119分鐘 90-119 minutes	9	6個小時或以上 6 hours or more
5	2個小時~不足3個小時 2 hours ~ less than 3 hours	10	一般沒有 Basically none

問卷完畢。謝謝。

This is the end of the questionnaire.
Thank you for participating.

兒童青少年（學生：6~22歲）- 初中一年級~高中三年級學生
Children and Adolescents (Students aged 6-22) - (Junior Secondary 1~Senior Secondary 3)

三. 檢測指標 (由監測人員在監測現場填寫)

Testing indicators (to be filled in by examiner on site)

1. 身高 (cm) Height (cm)	<input type="text"/> <input type="text"/> <input type="text"/> . <input type="text"/>
2. 坐高 (cm) Sitting height (cm)	<input type="text"/> <input type="text"/> . <input type="text"/>
3. 體重 (kg) Weight (kg)	<input type="text"/> <input type="text"/> <input type="text"/> . <input type="text"/>
4. 胸圍 (cm) Chest circumference (cm)	<input type="text"/> <input type="text"/> <input type="text"/> . <input type="text"/>
5. 腰圍 (cm) Waist circumference (cm)	<input type="text"/> <input type="text"/> <input type="text"/> . <input type="text"/>
6. 臀圍 (cm) Hip circumference (cm)	<input type="text"/> <input type="text"/> <input type="text"/> . <input type="text"/>
7. 體脂率 (%) Body fat percentage (%)	<input type="text"/> <input type="text"/> . <input type="text"/>
8. 肩寬 (cm) Shoulder width (cm)	<input type="text"/> <input type="text"/> . <input type="text"/>
9. 骨盆寬 (cm) Pelvis width (cm)	<input type="text"/> <input type="text"/> . <input type="text"/>
10. 足長 (cm) Foot length (cm)	<input type="text"/> <input type="text"/> . <input type="text"/>
11. 安靜脈搏 (次/分) Resting pulse (bpm)	<input type="text"/> <input type="text"/> <input type="text"/>
12. 收縮壓 (mmHg) Systolic blood pressure (mmHg)	<input type="text"/> <input type="text"/> <input type="text"/>
13. 舒張壓 (mmHg) Diastolic blood pressure (mmHg)	<input type="text"/> <input type="text"/> <input type="text"/>

2020年澳門市民體質監測數據登錄冊

Data Registration Manual of
2020 Physical Fitness Study of Macao SAR Residents

14.肺活量 (ml) Vital capacity (ml)	<input type="text"/> <input type="text"/> <input type="text"/> <input type="text"/>
15.斜身引體 (次) (6~12歲男) 引體向上 (次) (13~22歲男) 一分鐘仰臥起坐 (次) (6~22歲女) Inclined pull-ups (times) (6~12 years M) / Pull-ups (times) (13~22 years M) / One-minute sit-ups (times) (6~22 years F)	<input type="text"/> <input type="text"/> <input type="text"/>
16.立定跳遠 (cm) Standing long jump (cm)	<input type="text"/> <input type="text"/> <input type="text"/>
17.50米跑 (秒) 50m run (sec)	<input type="text"/> <input type="text"/> . <input type="text"/>
18.50×8往返跑 (秒) (6~12歲) / 800米跑 (秒) (13~22歲女) / 1000米跑 (秒) (13~22歲男) 50m×8 shuttle run (sec) (6~12 years) / 800m run (sec) (13~22 years F) / 1000m run (sec) (13~22 years M)	<input type="text"/> <input type="text"/> <input type="text"/> . <input type="text"/>
19.握力 (kg) Grip strength (kg)	<input type="text"/> <input type="text"/> . <input type="text"/>
20.縱跳 (cm) Vertical jump (cm)	<input type="text"/> <input type="text"/> . <input type="text"/>
21.背力 (kg) Back strength (kg)	<input type="text"/> <input type="text"/> <input type="text"/>
22.坐位體前屈 (cm) Sit and reach (cm)	<input type="text"/> <input type="text"/> <input type="text"/> . <input type="text"/>
23.閉眼單腳站立 (秒) One foot stands with eyes closed (OFSEC) (sec)	<input type="text"/> <input type="text"/> <input type="text"/>
24.選擇反應時 (秒) Choice reaction time (sec)	<input type="text"/> . <input type="text"/> <input type="text"/>

兒童青少年（學生：6~22歲）- 初中一年級~高中三年級學生
Children and Adolescents (Students aged 6~22) - (Junior Secondary 1~Senior Secondary 3)

25. 齲齒(6~18歲) Dental caries (6~18 years)		<table border="1"> <tr><td></td><td></td><td></td><td></td><td></td><td></td><td></td><td></td><td></td><td></td><td></td><td></td><td></td><td></td><td></td><td></td><td></td><td></td><td></td><td></td><td></td><td></td><td></td></tr> <tr><td></td><td></td><td></td><td></td><td></td><td></td><td></td><td></td><td></td><td></td><td></td><td></td><td></td><td></td><td></td><td></td><td></td><td></td><td></td><td></td><td></td><td></td><td></td></tr> </table>																																																									
		d		D		m		M		f		F																																															
26. 視力 Vision																																																											
裸眼視力 Naked eyes		左 Left		<input type="text"/>		右 Right		<input type="text"/>																																																			
串鏡校正 Refractive error correction		左 Left		正片 Positive lens _____		負片 Negative lens _____																																																					
串鏡校正 Refractive error correction		右 Right		正片 Positive lens _____		負片 Negative lens _____																																																					
屈光不正 Refractive errors		左 Left		<input type="text"/>		右 Right		<input type="text"/>																																																			
(0) 正常 Normal		(1) 近視 Nearsighted		(2) 遠視 Farsighted		(3) 其他 Others																																																					
27. 色覺檢查 Color vision deficiency exam																				<input type="text"/>																																							
(1) 正常 Normal		(2) 不正常 Abnormal																																																									

檢驗員簽署：

Examiner Signature : _____

4. University Students

2020

澳門市民體質監測
Physical Fitness Study of Macao SAR Residents

數據登錄冊
Data Registration Manual

兒童青少年(學生：6~22歲)
Children and Adolescents
(Students aged 6~22)

(大學生)
(University Students)

 澳門特別行政區政府體育局
Sports Bureau, Macao SAR



歡迎閣下參加2020年澳門市民體質監測！澳門市民體質監測是特區政府為推動大眾健身活動的開展而進行的調查研究。在此首先感謝閣下對監測的支持並認真、如實地填寫問卷，我們保證對閣下的個人資料保密，有關資料不會獨立出現或使用，它將是整體數據的組成部分。再次對閣下的真誠參與表示感謝！

如對調查內容和檢測項目有任何疑問，歡迎向體育局運動醫學中心垂詢！

電話：28810896，88934540

Thank you for participating in our 2020 Physical Fitness Study! This study is organized by the Macao SAR Government to promote Sports for All. We are grateful for your participation. Your honesty and sincerity in filling out the questionnaire are appreciated. We promise to keep your personal data confidential and we will not publish or use your data individually. It will only be used as part of the whole study for statistical purposes. Again, we would like to extend our most sincere gratitude for your participation!

For any enquiries regarding the questionnaire or testing items, please feel free to contact Sports Medicine Centre of Macao Sports Bureau!
Telephone: 28810896, 88934540

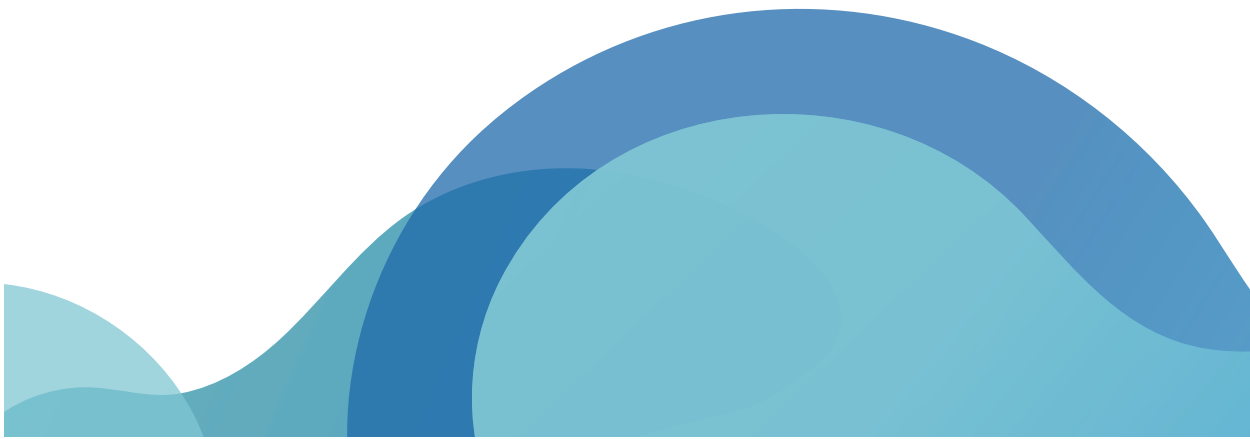

2020年澳門市民體質監測數據登錄冊

Data Registration Manual of
2020 Physical Fitness Study of Macao SAR Residents體育局轄下運動醫學中心預先聲明
Declaration
Sports Medicine Centre of Macao Sports Bureau

本聲明旨在向個人資料當事人或相關家長或監護人確保遵守第8/2005號法律“個人資料保護法”所規範的事宜。

This declaration is intended to assure data subjects or their parents or guardians that we will strictly comply with the relevant provisions of Act 8/2005 - Personal Data Protection Act.

1. 處理個人資料的負責人—體育局，地址設於澳門羅理基博士大馬路818號。代表—體育局局長。

Personal data controller: Macao Sports Bureau, at Av. Dr. Rodrigo Rodrigues, n.º 818, Macao.
Representative - President of Macao Sports Bureau.

2. 處理個人資料的目的—進行澳門市民體質監測，以便為制定日後關於體育及醫療護理的政策提供科學數據。收集的數據旨在更新僅為統計用途的數據庫。

Purposes of processing personal data: To conduct the physical fitness study for Macao residents, and provide scientific references for the development of relevant policies regarding sports and medical care. Data collected through the physical fitness study will only be used to update the database for statistical purposes.

3. 個人資料當事人類別—參與是次計劃的澳門居民（隨年齡抽樣）。

Categories of subjects with personal data: Macao residents participated in the study (random sampling by age).

4. 個人資料接收者—個人資料當事人（或相關家長或監護人），運動醫學中心及國家體育總局體育科學研究所。

Personal data recipients: Data subjects (or their parents or guardians), Sports Medicine Centre and China Institute of Sport Science.

5. 接收及處理個人資料的條件—個人資料當事人（或相關家長或監護人）享有第8/2005號法律賦予的所有權利如查閱權及更正所收集的個人資料。運動醫學中心承諾對不正確的數據進行更正，刪除或封鎖。

Conditions of receiving and processing personal data: Data subjects (or their parents or guardians) are entitled by Act 8/2005 - Personal Data Protection Act to the rights to access and rectify their own personal data collected. The Sports Medicine Centre hereby commits to take proper measures to rectify, delete or block any incorrect data.

兒童青少年（學生：6~22歲） - 大學生
Children and Adolescents (Students aged 6~22) - University Students

6.處理個人資料的安全和保密性—對處理及編輯個人資料絕對保密及採取適當措施以確保其安全。

Security and confidentiality of processing personal data: Appropriate measures are implemented to process and edit the personal data to ensure strict confidentiality, safety and security of the data.

本人已明白上述內容權益

I, the undersigned, am aware of the contents and my legal rights in the above declaration.

(個人資料當事人或家長或監護人簽名)
(Signature of subject providing personal
data/parents/guardian)

_____/_____/_____
(日) (月) (年)
(DD) (MM) (YY)

姓名：	_____
Name:	_____
性別：	_____
Gender:	_____
年齡：	_____ (周歲)
Age:	_____ (years)
就讀學校：	_____
School:	_____
聯繫電話：	_____
Phone:	_____

2020年澳門市民體質監測數據登錄冊

Data Registration Manual of
2020 Physical Fitness Study of Macao SAR Residents

一.分類編碼 General Information

填寫方法：

填寫選擇題時請將選擇答案的序號填入相應的方格中，如選答案（1），則在方格內填1；序號為兩位數時，兩位數字填入同一方格，如選項為（11），則將 填入同一方格，即填為 。在填寫多項選擇題時，如果僅選擇一個或兩個答案，則應在剩餘方格內填0。

Instructions for filling:

Please fill in the boxes with the corresponding numbers. For example, if the chosen answer is (1), fill in the box with "1". If the chosen option is a two digit number, write both digits in the same box. e.g. If the chosen option is (11), fill in the box with . For multiple choice questions, if only one or two option(s) were chosen, please fill in the remaining blank box(es) with "0".

1.澳門居民身份證號碼 Macao ID card number	<input type="text"/> <input type="text"/> <input type="text"/> <input type="text"/> <input type="text"/> <input type="text"/> <input type="text"/> <input type="text"/>		
2.性別 Gender	(1) 男 Male	(2) 女 Female	<input type="text"/>
3.出生日期 Date of birth	<input type="text"/> <input type="text"/> <input type="text"/> <input type="text"/> 年 Y	<input type="text"/> <input type="text"/> 月 M	<input type="text"/> <input type="text"/> 日 D
4.測試日期（由監測人員填寫） Examination date (to be filled in by examiner)	<input type="text"/> <input type="text"/> <input type="text"/> <input type="text"/> 年 Y	<input type="text"/> <input type="text"/> 月 M	<input type="text"/> <input type="text"/> 日 D
5.學校代碼（由監測人員填寫） School code number (filled in by examiner)	<input type="text"/> <input type="text"/> <input type="text"/> <input type="text"/>		
6.測試序號（由監測人員填寫） Serial number (filled in by examiner)	<input type="text"/> <input type="text"/> <input type="text"/> <input type="text"/>		
7.居住在澳門的年限（年）（指連續在澳門居住的年限，如果離開澳門的時間超過1年，則要由回澳門居住起重新計算居澳年限） Years of residence in Macao (It refers to years of continuous residence in Macao. If you had left Macao for over 1 year, years of residence in Macao should be recalculated from the time of returning to Macao.)	<input type="text"/> <input type="text"/>		

兒童青少年（學生：6~22歲） - 大學生
Children and Adolescents (Students aged 6~22) - University Students

8. 在學校就讀年級 Academic year	<input type="checkbox"/>
(1) 預科 Foundation	(2) 大學一年級 First year
(3) 大學二年級 Second year	(4) 大學三年級 Third year
(5) 大學四年級 Fourth year	(6) 大學五年級 Fifth year
(7) 研究生 Postgraduate	
9. 日常主要勞作方式 Labor intensity of daily work	<input type="checkbox"/>
(1) 以靜坐伏案等靜態性活動為主（如用電腦、書寫等） Mainly sedentary work (such as computer use, paperwork, etc.)	
(2) 日常勞作中以靜坐伴有上肢活動，或大部份時間多以站立或走動為主（如計程車司機、售貨員、流水線組裝工等） Mainly work done seated with upper limb movements, or standing or walking during most of the work time (such as taxi drivers, sales personnel, assembly line workers, etc.)	
(3) 日常勞作中主要從事重體力性活動、搬運或舉重物、挖掘等（如建築工人等） Mainly heavy physical activities, manual load handling or lifting, digging, etc. (such as construction workers, etc.)	
10. 出生地 Place of birth	<input type="checkbox"/>
(1) 中國大陸 Mainland China	(2) 澳門 Macao
(3) 香港 Hong Kong	(4) 葡萄牙 Portugal
(5) 其他 Others	
11. 居住地所屬堂區 Parish of residence	<input type="checkbox"/>
(1) 聖方濟各堂區（路環） Paróquia de São Francisco Xavier (Coloane)	
(2) 聖嘉模堂區（氹仔） Paróquia de Nossa Senhora do Carmo (Taipa)	
(3) 風順堂區（包括媽閣山、西望洋山、下環及內港一帶） Paróquia de S. Lourenço (Zonas das Colinas da Barra e da Penha, da Praia do Manduco e do Porto Interior)	
(4) 大堂區（新馬路一帶、南灣、水坑尾、新口岸南北地段及南灣湖發展區） Paróquia da Sé Catedral (Zonas da Almeida Ribeiro, da Praia Grande, da Rua do Campo, dos Lotes norte e sul do Porto Exterior e da Zona do Lago Nam Van)	
(5) 花王堂區（聖安多尼堂區，在澳門西部，包括高士德大馬路、新橋和沙梨頭） Paróquia de Santo António (Zonas da Freguesia de Santo António, do Oeste de Macau, incluindo Av. Horta e Costa, de San Kiu e do Patane)	
(6) 望德堂區（包括荷蘭園、松山一帶） Paróquia de S. Lázaro (Zona do Conselheiro Ferreira de Almeida e da Colina da Guia)	
(7) 花地瑪堂區（俗稱北區，包括青洲、台山、黑沙環、筷子基和水塘） Paróquia de Nossa Senhora de Fátima (Zonas do Norte, incluindo Ilha Verde, Tamagnini Barbosa, Areia Preta, Fái Chi Kei e Reservatório)	

2020年澳門市民體質監測數據登錄冊

Data Registration Manual of
2020 Physical Fitness Study of Macao SAR Residents

<p>12.近5年曾患過何種疾病（經醫院確診的疾病）（選擇“無”者請直接回答問題第14題） Any hospital-diagnosed diseases suffered within the past 5 years? (If the answer is “no”, skip to Question 14)</p> <p>(1) 有 (2) 無 Yes No</p>			<input type="checkbox"/>
<p>13.患病種類（患病者按主次順序，最多可填寫3項） Diseases suffered (in order of precedence, choose up to 3 diseases)</p>			<input type="text"/> <input type="text"/> <input type="text"/>
(1) 急性支氣管炎 Acute bronchitis	(2) 肺炎 Pneumonia	(3) 哮喘 Pneumonia	
(4) 肺結核 Tuberculosis	(5) 急性慢性腸炎、胃炎 Acute/chronic enteritis, gastritis	(6) 胃潰瘍 Gastric ulcer	
(7) 口腔潰瘍 Mouth ulcer	(8) 牙齦炎 Gingivitis	(9) 急性慢性咽喉炎 Acute/chronic pharyngitis	
(10) 急性慢性鼻炎 Acute/chronic rhinitis	(11) 中耳炎 Otitis media	(12) 腳癬 Tinea pedis	
(13) 過敏性皮炎 Allergic dermatitis	(14) 急性尿道炎 Acute urethritis	(15) 痛經、月經不調 Dysmenorrhea, irregular menses	
(16) 風疹、麻疹、水痘 Rubella, measles, varicella	(17) 高血壓 Hypertension	(18) 貧血 Anemia	
(19) 腎炎 Nephritis	(20) 肝炎 Hepatitis	(21) 心臟病 Heart disease	
(22) 糖尿病 Diabetes	(23) 高血脂 Hyperlipemia	(24) 抑鬱症 Depression	
(25) 甲亢 Hyperthyroidism	(26) 頸椎病 Cervical spondylosis	(27) 意外傷害(造成人體的損傷而 需要醫治或影響了正常的活動) Accidental injury (injury to the body that needs treatments, or injury that affects normal activities)	
(28) 其他 Others			
<p>14.有沒有每天刷牙習慣 Do you brush your teeth every day?</p> <p>(1) 有 (2) 無 Yes No</p>			<input type="checkbox"/>
<p>15.除刷牙外，有沒有每天使用牙線 Do you use dental floss in addition to tooth-brushing every day?</p> <p>(1) 有 (2) 無 Yes No</p>			<input type="checkbox"/>

兒童青少年（學生：6~22歲） - 大學生
Children and Adolescents (Students aged 6~22) - University Students

16. 過去12個月有沒有到牙醫診所進行牙科檢查 Did you go to a dental clinic for dental examination within the past 12 months? (1) 有 Yes (2) 無 No	<input type="checkbox"/>
17. 是否有齲齒（選擇“無”或“不知道”者請直接回答第二部份：健身素養問卷問題） Do you have any decayed tooth? (If the answer is “no” or “don’t know”, skip to II. Fitness Literacy) (1) 有 Yes (2) 無 No (3) 不知道 Don't know	<input type="checkbox"/>
18. 如有齲齒，有沒有到牙醫診所進行治療？ If yes, have you visited a dental clinic for treatment? (1) 有 Yes (2) 無 No	<input type="checkbox"/>

2020年澳門市民體質監測數據登錄冊

Data Registration Manual of
2020 Physical Fitness Study of Macao SAR Residents

二. 健身素養問卷 Fitness Literacy

A-知識、認知和態度 Knowledge, cognition and attitude

A1. 【單選題】您認為以下說法是否正確，正確選1、不正確選2、不知道選3，並在您選的數字上畫“○”。

[Single choice question] Which of the following descriptions do you think are correct? Choose 1 for "Correct", 2 for "Incorrect", 3 for "Don't know", and circle each corresponding number with "○".

題目 Question	正確 Correct	不正確 Incorrect	不知道 Don't know
1) 清晨是鍛煉的最佳時間 Morning is the best time for physical exercise.	1	2	3
2) 大強度運動有利於減肥 High-intensity exercise is good for losing weight.	1	2	3
3) 吃飯後需要休息約30分鐘再去散步 A 30 minute rest is needed after eating before going for a walk.	1	2	3
4) 跑步應該選擇堅硬平坦的地面 Choose hard and flat ground when running.	1	2	3
5) 跳繩可以預防骨質疏鬆 Rope skipping can prevent osteoporosis.	1	2	3
6) 體育鍛煉時最好穿純棉服裝 It is best to wear pure cotton clothing when exercising.	1	2	3
7) 游泳後不能立刻吃東西 Don't eat right after swimming.	1	2	3
8) 運動處方是指針對某一類人群的身體狀況，採用處方的形式規定健身者鍛煉的內容和運動量的方法 Exercise prescription is used to specify the content and amount of exercise in the form of prescription, according to the physical condition of a targeted group.	1	2	3
9) 腹式呼吸是指開始吸氣時全身用力，此時胸部及腹部會充滿空氣而鼓起，然後用力將氣吐出 Abdominal breathing refers to the breathing method of inhaling deeply to fill the chest and bulging belly with air, and then exhaling deeply.	1	2	3
10) 有氧運動是人體在氧氣充分供應的情況下進行運動強度低、運動時間較長且富韻律性的體育鍛煉，如游泳、慢跑 Aerobic exercise is a kind of rhythmic exercise that is low intensity and long duration under the condition of sufficient oxygen supply, such as swimming and jogging.	1	2	3

兒童青少年（學生：6~22歲） - 大學生
Children and Adolescents (Students aged 6~22) - University Students

A2. 【單選題】以下說法您是否同意，非常不贊同選1、不太贊同選2、一般選3、比較贊同選4、非常贊同選5，並在您選的數字上畫“○”。

【Single choice question】Which of the following descriptions do you agree with? Choose 1 for “Strongly disagree”, 2 for “Slightly disagree”, 3 for “Neutral”, 4 for “Relatively agree”, 5 for “Strongly agree”, and circle each corresponding number with “○”.

題目 Question	非常不贊同 Strongly disagree	不太贊同 Slightly disagree	一般 Neutral	比較贊同 Relatively agree	非常贊同 Strongly agree
1) 總體來評價，健身活動是一項積極向上的活動 Generally speaking, fitness activity is an activity that is positive.	1	2	3	4	5
2) 健身活動有益於保持身體健康 Fitness activity is good for body health.	1	2	3	4	5
3) 健身活動可以舒緩焦慮、煩躁的情緒 Fitness activity can relieve anxiety or irritability.	1	2	3	4	5
4) 健身活動可以增強人的意志 Fitness activity can hone the will.	1	2	3	4	5
5) 健身活動是無趣的 Fitness activity is boring.	1	2	3	4	5
6) 健身活動是非常值得去做的活動 Fitness activity is well worth doing.	1	2	3	4	5
7) 健身是我生活中可以缺少的一部分 Exercising is a part of my life that I can live without.	1	2	3	4	5
8) 不管多忙，都應該抽時間去健身 We should spare time for exercising no matter how busy we are.	1	2	3	4	5
9) 把錢花在健身方面是值得的 Spending money on exercising is worthwhile.	1	2	3	4	5
10) 我願意說服周圍的人同我一起健身 I would like to persuade others to work out with me.	1	2	3	4	5

2020年澳門市民體質監測數據登錄冊

Data Registration Manual of
2020 Physical Fitness Study of Macao SAR Residents

A3. 【單選題】下面的說法是否符合您的實際情況？非常不符合選1、不太符合選2、一般選3、比較符合選4、非常符合選5，並在您選的數字上畫“○”。

【Single choice question】 Which of the following descriptions is consistent with your situation? Choose 1 for “Very inconsistent”, 2 for “Not quite consistent”, 3 for “Neutral”, 4 for “Slightly consistent”, 5 for “Very consistent”, and circle each corresponding number with “○”.

題目 Question	非常不符合 Very inconsistent	不太符合 Not quite consistent	一般 Neutral	比較符合 Slightly consistent	非常符合 Very consistent
1) 我已經掌握的體育鍛煉技能是正確的、科學的 I think the exercising skills that I have acquired are correct and scientific.	1	2	3	4	5
2) 已經或正準備去瞭解、諮詢一下體育健身的專業人士（如體育老師、健身教練、電視節目），聽一下他們的專業意見 I have visited or am planning to consult with sports and fitness professionals (e.g., PE teachers, fitness coaches, TV shows) and get their professional advice.	1	2	3	4	5

兒童青少年（學生：6~22歲）- 大學生
Children and Adolescents (Students aged 6~22) - University Students

B-健身技能 Fitness skills

B1. 【多選排序題】您體育鍛煉的主要項目有哪些？本題為多選題，可選1個或1個以上的答案，請圈選所有您主要參加的體育鍛煉項目，在選項對應的序號上畫“○”，並按照經常參加的頻率由高到低排序後將對應序號填寫如下：、、、、、、。如果沒有參加過任何運動項目只圈選33即可。

【Multiple-choice sorting question】What are the physical exercises in which you frequently participated? This is a multiple choice question. You need to choose at least 1 option. Choose the physical exercises you have frequently participated, circle the corresponding number with “○”, and fill in the blanks in descending order of frequency as follows: , , , , , , . If your answer is “None”, circle the number 33.

1	步行（健步走） Walking (Brisk walking)	12	門球、地擲球 Gate ball, bocce ball	23	騎自行車 Cycling
2	跑步 Running	13	高爾夫球 Golf	24	瑜伽、普拉提 Yoga, Pilates
3	跳高 High jump	14	柔力球 Softball	25	力量、健美（徒手、器械） Strength exercises, body building (bodyweight training, equipment workout)
4	跳遠 Long jump	15	健身操類（體操、健美操等） Aerobics (such as gymnastics, aerobics, etc.)	26	滑冰 Skating
5	登山、攀岩 Hiking, rock climbing	16	舞蹈類（廣場舞、民族舞等） Dancing (such as square dance, folk dance, etc.)	27	滑雪 Skiing
6	籃球 Basketball	17	武術（武術套路、太極、木蘭等） Martial arts (such as series of skills, taiji, mulan, etc.)	28	游泳 Swimming
7	排球 Volleyball	18	健身氣功（易筋經、八段錦、五禽戲、 六字訣等） Qigong (such as yijinjing, baduanjin, wuqinxi, liuzijue, etc.)	29	跳繩 Rope skipping
8	足球 Football	19	拳擊、摔跤、散打 Boxing, wrestling, free combat	30	踢毽 Shuttlecock kicking
9	網球 Tennis	20	跆拳道 Taekwondo	31	輪滑 Roller skating
10	乒乓球 Table tennis	21	空手道 Karate	32	其他 Other
11	羽毛球 Badminton	22	柔道 Judo	33	沒有參加過任何運動項目 （不用回答B2、C1題） None (skip Questions B2, C1)

Data Registration Manual of
2020 Physical Fitness Study of Macao SAR Residents

B2. 【多選排序題】您能夠熟練掌握的體育鍛煉項目有哪些（熟練是指自己能掌握某項運動的基本技能和基本比賽規則）？本題為多選題，可選1個或1個以上的答案，請圈選所有您熟練掌握的運動項目，在選項對應的序號上畫“○”，並按照熟練程度排序後將對應序號填寫如下：、、、、、、、、。如果沒有熟練掌握的項目只圈選33即可。

【Multiple-choice sorting question】What kind of physical exercises are you proficient in (Proficiency means that you have acquired the basic skills and basic competition rules of an exercise)? This is a multiple choice question. You need to choose at least 1 option. Choose all the physical exercises in which you are proficient at, circle the corresponding number with “○”, and fill in the blanks in descending order of proficiency as follows: , , , , , , , . If your answer is “None”, circle the number 33.

1	步行（健步走） Walking (Brisk walking)	12	門球、地擲球 Gate ball, bocce ball	23	騎自行車 Cycling
2	跑步 Running	13	高爾夫球 Golf	24	瑜伽、普拉提 Yoga, Pilates
3	跳高 High jump	14	柔力球 Softball	25	力量、健美（徒手、器械） Strength exercises, body building (bodyweight training, equipment workout)
4	跳遠 Long jump	15	健身操類（體操、健美操等） Aerobics (such as gymnastics, aerobics, etc.)	26	滑冰 Skating
5	登山、攀岩 Hiking, rock climbing	16	舞蹈類（廣場舞、民族舞等） Dancing (such as square dance, folk dance, etc.)	27	滑雪 Skiing
6	籃球 Basketball	17	武術（武術套路、太極、木蘭等） Martial arts (such as series of skills, taiji, mulan, etc.)	28	游泳 Swimming
7	排球 Volleyball	18	健身氣功（易筋經、八段錦、五禽戲、 六字訣等） Qigong (such as yijinjing, baduanjin, wuqinxi, liuzijue, etc.)	29	跳繩 Rope skipping
8	足球 Football	19	拳擊、摔跤、散打 Boxing, wrestling, free combat	30	踢毽 Shuttlecock kicking
9	網球 Tennis	20	跆拳道 Taekwondo	31	輪滑 Roller skating
10	乒乓球 Table tennis	21	空手道 Karate	32	其他 Other
11	羽毛球 Badminton	22	柔道 Judo	33	沒有熟練掌握的項目 None

兒童青少年（學生：6~22歲） - 大學生
Children and Adolescents (Students aged 6~22) - University Students

B3. 【多選題】 您知道運動前要做的準備活動有哪些？本題為多選題，可選1個或1個以上的答案，請圈選所有您知道的準備活動，在選項對應的序號上畫“○”。如果沒有知道的準備活動只圈選10即可。)

[Multiple choice question] What kinds of warm-up exercises should be done before exercising? This is a multiple choice question. You need to choose at least 1 option. Choose all the warm-up exercises you know, and circle each corresponding number with “○”. If your answer is “None”, circle the number 10.

1 慢跑 Jogging	6 壓腿（包括前壓腿和側壓腿） Leg stretch (including forward lunge stretch and side lunge stretch)
2 腰部運動（如扭腰） Waist movement (such as waist twisting)	7 體前屈 Forward bend
3 肩部運動（轉動肩膀） Shoulder movement (rolling shoulders)	8 原地高抬腿 High-knee running in place
4 關節活動（包括手腕關節、頸關節和腳踝關節） Joint movement (including wrist, neck and ankle joints)	9 其他 Others
5 擴胸運動 Chest expansion exercise	10 沒有知道的準備活動（不用回答B4題） None (skip Question B4)

B4. 【多選題】 您能夠熟練掌握的準備活動有哪些（熟練是指自己獨立會做某項準備活動）？本題為多選題，可選1個或1個以上的答案，請圈選所有您熟練掌握的準備活動，在選項對應的序號上畫“○”。如果沒有熟悉掌握的準備活動只圈選10即可。

[Multiple choice question] What kind of warm-up exercises are you proficient in (Proficiency means that you can do a warm-up exercise on your own)? This is a multiple choice question. You need to choose at least 1 option. Choose all the warm-up exercises in which you are proficient, and circle each corresponding number with “○”.

1 慢跑 Jogging	6 壓腿（包括前壓腿和側壓腿） Leg stretch (including forward lunge stretch and side lunge stretch)
2 腰部運動（如扭腰） Waist movement (such as waist twisting)	7 體前屈 Forward bend
3 肩部運動（轉動肩膀） Shoulder movement (rolling shoulders)	8 原地高抬腿 High-knee running in place
4 關節活動（包括手腕關節、頸關節和腳踝關節） Joint movement (including wrist, neck and ankle joints)	9 其他 Others
5 擴胸運動 Chest expansion exercise	10 沒有熟練掌握的準備活動 None

2020年澳門市民體質監測數據登錄冊

Data Registration Manual of
2020 Physical Fitness Study of Macao SAR Residents

B5. 【單選題】下面的說法是否符合您的實際情況？非常不符合選1、不太符合選2、一般選3、比較符合選4、非常符合選5，並在您選的數字上畫“○”。

【Single choice question】 Which of the following descriptions is consistent with your situation? Choose 1 for “Very inconsistent”, 2 for “Not quite consistent”, 3 for “Neutral”, 4 for “Slightly consistent”, 5 for “Very consistent”, and circle each corresponding number with “○”.

題目 Question	非常不符合 Very inconsistent	不太符合 Not quite consistent	一般 Neutral	比較符合 Slightly consistent	非常符合 Very consistent
1) 能夠結合自己的情況選擇適合自己的體育鍛煉項目 I can choose physical exercises that suit me.	1	2	3	4	5
2) 能夠根據自身狀況合理的制定健身計劃 I can reasonably develop a fitness plan based on my actual condition.	1	2	3	4	5
3) 能夠根據實際情況及時對健身計劃作出調整 I can promptly adjust my fitness plan based on my actual condition.	1	2	3	4	5

B6. 【單選題】下面的說法是否符合您的實際情況？非常不符合選1、不太符合選2、一般選3、比較符合選4、非常符合選5，並在您選的數字上畫“○”。

【Single choice question】 Which of the following descriptions is consistent with your situation? Choose 1 for “Very inconsistent”, 2 for “Not quite consistent”, 3 for “Neutral”, 4 for “Slightly consistent”, 5 for “Very consistent”, and circle each corresponding number with “○”.

題目 Question	非常不符合 Very inconsistent	不太符合 Not quite consistent	一般 Neutral	比較符合 Slightly consistent	非常符合 Very consistent
1) 對於喜歡的健身項目，您認為已經很好地掌握了該健身項目所要求的技能 I think I have adequately acquired the skills of exercises that I like.	1	2	3	4	5
2) 只要自己願意，您可以堅持進行健身活動 I can persist in exercising if I want to.	1	2	3	4	5

兒童青少年（學生：6~22歲） - 大學生
Children and Adolescents (Students aged 6~22) - University Students

C-習慣養成 Habit formation

C1. 【單選題】您是如何選中B1題中的這些體育鍛煉項目的？請在您選中的選項對應的序號上畫“○”。

【Single choice question】 How did you choose the physical exercises in Question B1? Choose the proper answer and circle its corresponding number with “○”.

1	自己隨便選的 I chose them randomly	4	跟著家人、朋友或同學等選的 I followed the choices of my family members, friends or schoolmates.
2	哪些項目練起來方便就選哪些 I chose them because they are convenient to do.	5	哪些項目容易就選哪些 I chose them because they are easy to do.
3	跟著潮流走的 Follow the general trend.	6	諮詢過專業意見 I chose them after seeking for professional advice.

C2. 【限選排序題】阻礙您開展體育鍛煉的原因是甚麼？本題為限選排序題，請圈選出3個對您來說最主要的原因，在選項對應的序號上畫“○”，並依據重要程度由高到低進行排序後將序號依次填寫在以下方框上：、、。

【Three-choice sorting question】 What are the main obstacles refraining you from doing exercise? This is a three-choice sorting question. Choose the top 3 reasons, and circle each corresponding number with “○”, and fill in the blanks in order of precedence as follows: , , .

1	學業/工作忙 Busy school work/busy work	7	沒有健身場地 Lack of suitable venues
2	家務忙 Too many house chores	8	健身場地距離太遠 Lack of fitness venues nearby
3	怕受傷 To avoid physical injury	9	周邊缺少體育健身組織 Lack of fitness clubs nearby
4	經濟條件不允許 Financial restraint	10	群眾性的健身賽事或者活動太少 Lack of events or activities for residents
5	對體育鍛煉沒有興趣 Lack of interest	11	社區組織開展的活動項目少，缺乏吸引力 Lack of such activities in community, or activities less attractive
6	不知道該怎麼鍛煉，缺乏指導 Lack of coaching advice	12	其他 Others

2020年澳門市民體質監測數據登錄冊

Data Registration Manual of
2020 Physical Fitness Study of Macao SAR Residents

C3. 【單選題】您現在的工作狀態（是指您的職業活動，含義工或志願者工作但不包含家庭主婦/夫所從事的家務工作）如何？請在您選中的選項對應的序號上畫“○”，如果選擇1則同時填寫方框的內容。

【Single choice question】What is your current work status (i.e. your profession's activities, including volunteer work, but not including house chores conducted as housewives/husbands)? Choose the proper answer and circle its corresponding number with “○”, If you choose Option 1, fill in the blanks with answers.

1	每週工作 <input type="text"/> 天，平均每天工作 <input type="text"/> 小時 I work <input type="text"/> hours per day, <input type="text"/> days per week.
2	有工作但不定時 No regular work
3	不工作（不用回答C4題） Unemployed (skip Question C4)

C4. 【填空題】您工作中的體力活動狀況如何？請認真讀題後，在“”處填寫您的實際情況，如果沒有以下情況的請填“0”。注：填寫時間通常為10的倍數。

【Blank-filling question】What is the labor intensity of your daily work? Read the question carefully, and fill in the blanks “” according to your actual conditions. If it is not applicable, write “0”. Note: The number you fill in should be a multiple of 10.

1) 您的工作中通常每週有多少天會做“呼吸和心跳顯著增加（如搬運或舉重物、挖掘或建築工作等）”持續時間10分鐘以上的劇烈活動？天；您通常一天工作中累計做多長時間的這種持續10分鐘以上的劇烈活動？分鐘。

How many days in a typical week at work do you do vigorous activities (e.g. manual load handling or lifting, digging or construction work) lasting for more than 10 minutes with “significantly increased breathing and heart rate”? days; What is the average cumulative time you spent on doing such vigorous activities lasting for more than 10 minutes at work in a typical day? minutes.

2) 您的工作中通常每週有多少天會做“呼吸和心跳輕度增加（如快步走、搬運較輕的物品）”持續時間10分鐘以上的中等強度活動？天；您通常一天工作中累計做多長時間的這種持續10分鐘以上的中等強度活動？分鐘。

How many days in a typical week at work do you do moderate-intensity activities (e.g. brisk walking, manual handling of light objects) lasting for more than 10 minutes with “slightly increased breathing and heart rate”? days; What is the average cumulative time you spent doing such moderate-intensity activities lasting for more than 10 minutes at work in a typical day? minutes.

C5. 【填空題】您通常每天有多少時間坐著或者靠著？注：填寫分鐘通常為10的倍數。

【Blank-filling question】What is your average sitting or reclining time per day? Note: The number you fill in should be a multiple of 10.

請填寫：小時 分鐘。
Please fill in the blanks: hours minutes

兒童青少年（學生：6~22歲） - 大學生
Children and Adolescents (Students aged 6~22) - University Students

C6. 【**填空題**】您通常每天睡眠（包括午睡）多少時間？注：填寫分鐘通常為10的倍數。

【Blank-filling question】What is your average sleep time (including naps) per day? Note: The number you fill in should be a multiple of 10.

請填寫：
Please fill in the blanks: 小時 分鐘。

C7. 【**單選題**】您通常最主要的交通出行方式是甚麼？請在您選中選項對應的序號上畫“○”。

【Single choice question】What is your major means of transportation? Choose the proper answer and circle its corresponding number with “○”.

1	步行 On foot	4	駕車 Driving
2	騎自行車 Bicycling	5	乘公共交通、乘坐私家車或乘坐電單車等 By public transport, private car or motorcycle
3	騎電單車 Motorcycling	6	其他 Others

C8. 【**填空題**】您通常每週有多少天的出行交通方式為步行或騎自行車持續時間10分鐘以上（出行指的包括從家到學校、教室到宿舍、去購物、參加聚會等等，但不包括專為體育鍛煉而進行的步行或者騎行）？天；您通常一天在交通方面累計花多長時間這種持續10分鐘以上的步行或者騎自行車？分鐘。注：填寫時間通常為10的倍數；如果沒有這種情況的請填“0”。

【Blank-filling question】How many days do you walk or cycle for at least 10 minutes continuously in a typical week (It refers to the total time spent on commuting from home to school, from classroom to dormitory, shopping and attending parties, etc., but do not include walking or cycling specifically for exercising)? days; What is the average cumulative commuting time you spent on walking or cycling for at least 10 minutes continuously in a typical day? minutes. Note: The number you fill in should be a multiple of 10; if it is not applicable, write “0”.

C9. 【**填空題**】您在做家務過程中的體力活動狀況如何？請認真讀題後，在“”處填寫您的實際情況，如果沒有以下情況的請填“0”。注：填寫時間通常為10的倍數。

【Blank-filling question】What is the labor intensity of your daily house chores? Read the question carefully, and fill in the blanks “” according to your actual conditions. If it is not applicable, write “0”. Note: The number you fill in should be a multiple of 10.

1) 您生活中通常每週有多少天會從事持續時間10分鐘以上、大強度的家務勞動（比如搬提重物、庭院挖土等）？天；平均一天累計會做多長時間這種持續10分鐘以上的大強度家務勞動？分鐘。

How many days in a typical week do you do high-intensity house chores (e.g. manual load handling or lifting, digging in the yard, etc.) lasting for more than 10 minutes?

days; What is the average cumulative time you spent on doing such high-intensity house chores lasting for more than 10 minutes in a typical day? minutes

2020年澳門市民體質監測數據登錄冊

Data Registration Manual of
2020 Physical Fitness Study of Macao SAR Residents

- 2) 您生活中通常每週有多少天會從事持續時間10分鐘以上、中等強度的家務勞動（比如搬提輕物、擦窗、擦地、打掃房間等）？天；平均一天累計會做多長時間這種持續10分鐘以上的中等強度家務勞動？分鐘。

How many days in a typical week do you do moderate-intensity house chores (e.g. handling or lifting light objects, wiping the window, mopping the floor, cleaning the room, etc.) lasting for more than 10 minutes? days; What is the average cumulative time you spent doing such moderate-intensity house chores lasting for more than 10 minutes in a typical day? minutes

- C10. 【限選排序題】請問您通常會從事哪些閒暇活動？本題為限選排序題，請圈選出3件最經常做的事，在選項對應的序號上畫“○”，並依據花費時間由長到短進行排序後將序號依次填寫在以下方框上：、、。

[Three-choice sorting question] What kind of leisure-time activities do you usually do? This is a three-choice sorting question. Choose the top 3 activities you most frequently do. Circle each corresponding number with “○”, and fill in the blanks in descending order of time spent as follows:

, , .

1	看電視 Watching TV	8	園藝、照顧寵物 Garden work, pet caring	15	手工（編制、刺繡、陶藝） Doing handwork (knitting, embroidery, pottery)
2	聽廣播、音樂 Listening to radio and music	9	遛狗 Walking my dog	16	到現場觀看體育比賽 Watching sports event on site
3	玩電腦/手機/遊戲機 Using computers/mobile/ game console	10	唱歌、唱戲 Karaoke	17	郊遊 Outing
4	讀書、看報 Reading books and newspaper	11	逛街、遊玩 Hanging out	18	補充睡眠 Napping
5	打牌、下棋 Playing chess or poker	12	做家務 Doing house chores	19	陪孩子玩 Accompanying my child
6	聊天、聚會 Chatting, social gathering	13	書法、繪畫、彈琴 Calligraphy, painting, playing music instrument	20	陪孩子做功課及復習 Assisting my child with homework
7	體育鍛煉 Exercising	14	看演出/電影 Watching shows/movies	21	其他 Others

兒童青少年（學生：6~22歲）- 大學生
Children and Adolescents (Students aged 6~22) - University Students

C11. 【單選題】您日常參加體育鍛煉的頻率如何？請在您選中的選項對應的序號上畫“○”。

【Single choice question】What is your exercise frequency? Choose the proper answer and circle its corresponding number with “○”.

1	平均每週7次或以上 7 times or more on average per week	6	平均每週2次 Twice a week on average
2	平均每週6次 6 times on average per week	7	平均每週1次 Once a week on average
3	平均每週5次 5 times on average per week	8	平均每月1次或以上，但每週不足1次 Once or more per month, but less than once a week on average
4	平均每週4次 4 times on average per week	9	平均每月不足1次 Fewer than once a month
5	平均每週3次 3 times on average per week	10	從不參加體育鍛煉（不用回答C12至C16題） Never (skip Questions C12-C16)

C12. 【單選題】多數情況下，您每次能鍛煉多長時間？請在您選中的選項對應的序號上畫“○”。

【Single choice question】What is your exercise duration each time in most cases? Choose the proper answer and circle its corresponding number with “○”.

1	10分鐘以下 Less than 10 minutes	4	30至59分鐘 30-59 minutes
2	10~19分鐘 10-19 minutes	5	60至119分鐘 60-119 minutes
3	20~29分鐘 20-29 minutes	6	120分鐘或以上 120 minutes or more

C13. 【單選題】多數情況下，您每次進行體育鍛煉時的身體感受是甚麼樣的？請在您選中的選項對應的序號上畫“○”。

【Single choice question】In most cases, how do you feel physically during exercising? Choose the proper answer and circle its corresponding number with “○”.

1	呼吸、心跳變化不大 Unchanged breathing and heart rate	2	呼吸、心跳加快，微微出汗 Slightly increased breathing, heart rate and slight sweating	3	呼吸急促，心跳明顯加快，出汗較多 Significantly increased breathing, heart rate and increased sweating
---	---	---	--	---	--

2020年澳門市民體質監測數據登錄冊

Data Registration Manual of
2020 Physical Fitness Study of Macao SAR Residents

C14. 【**填空題**】 您每週參加體育鍛煉的具體情況如何？請認真讀題後，在“”處填寫您的實際情況，如果沒有以下情況或不能每週都做，可以填“0”。注：填寫時間通常為10的倍數。

【Blank-filling question】 What are your actual conditions when you do physical exercises each week? Read the question carefully, and fill in the blanks according to your actual conditions. If it is not applicable, write “0”. Note: The number you fill in should be a multiple of 10.

1) 您平均每週有多少天從事每次持續時間10分鐘以上的呼吸心跳明顯加快、出汗較多的大強度體育鍛煉？天；平均一天次；平均每次分鐘。

How many days in a typical week do you do high-intensity physical exercises lasting for more than 10 minutes with significantly increased breathing & heart rate and increased sweating?

day(s) a week; time(s) a day; minutes each time.

2) 您平均每週有多少天從事每次持續時間10分鐘以上的呼吸心跳加快、微微出汗的中等強度體育鍛煉？天；平均一天次；平均每次分鐘。

How many days in a typical week do you do moderate-intensity physical exercises lasting for more than 10 minutes with slightly increased breathing & heart rate and slight sweating?

day(s) a week; time(s) a day; minutes each time.

C15. 【**單選題**】 按上述C11~C14題選擇的頻率、時間及強度開展體育鍛煉，您堅持了多長時間？請在您選中的最接近的選項對應的序號上畫“○”。

【Single choice question】 How long have you been exercising as per the exercise frequency, duration and intensity chosen in Questions C11~C14? Choose the proper answer and circle its corresponding number with “○”.

1	沒有 N/A	3	1個月或以上，但不足3個月 1 month or more, but less than 3 months	5	半年或以上，但不足1年 Half a year or more, but less than 1 year
2	不足1個月 Less than 1 month	4	3個月或以上，但不足半年 3 months or more, but less than half a year	6	1年或以上 1 year or more

兒童青少年（學生：6~22歲） - 大學生
Children and Adolescents (Students aged 6~22) - University Students

C16. 【單選題】您通常每週有幾天進行力量練習(包括俯臥撐、仰臥起坐、引體向上、深蹲等徒手練習或使用啞鈴、彈力帶等健身器械的練習)? 請在您選中的選項對應的序號上畫“○”。

【Single choice question】 How many days in a week do you do strength exercises usually (including bodyweight training such as push-ups, sit-ups, pull-ups, and squats; or equipment workout such as using dumbbells and elastic bands)? Choose the proper answer and circle its corresponding number with “○”.

1	1天 1 day	5	5天 5 days
2	2天 2 days	6	6天 6 days
3	3天 3 days	7	7天 7 days
4	4天 4 days	8	0天 0 day

問卷完畢。謝謝。

This is the end of the questionnaire.
Thank you for participating.

2020年澳門市民體質監測數據登錄冊

Data Registration Manual of
2020 Physical Fitness Study of Macao SAR Residents

三. 檢測指標 (由監測人員在監測現場填寫)

Testing indicators (to be filled in by examiner on site)

1. 身高 (cm) Height (cm)	<input type="text"/> <input type="text"/> <input type="text"/> . <input type="text"/>
2. 坐高 (cm) Sitting height (cm)	<input type="text"/> <input type="text"/> . <input type="text"/>
3. 體重 (kg) Weight (kg)	<input type="text"/> <input type="text"/> <input type="text"/> . <input type="text"/>
4. 胸圍 (cm) Chest circumference (cm)	<input type="text"/> <input type="text"/> <input type="text"/> . <input type="text"/>
5. 腰圍 (cm) Waist circumference (cm)	<input type="text"/> <input type="text"/> <input type="text"/> . <input type="text"/>
6. 臀圍 (cm) Hip circumference (cm)	<input type="text"/> <input type="text"/> <input type="text"/> . <input type="text"/>
7. 體脂率 (%) Body fat percentage (%)	<input type="text"/> <input type="text"/> . <input type="text"/>
8. 肩寬 (cm) Shoulder width (cm)	<input type="text"/> <input type="text"/> . <input type="text"/>
9. 骨盆寬 (cm) Pelvis width (cm)	<input type="text"/> <input type="text"/> . <input type="text"/>
10. 足長 (cm) Foot length (cm)	<input type="text"/> <input type="text"/> . <input type="text"/>
11. 安靜脈搏 (次/分) Resting pulse (bpm)	<input type="text"/> <input type="text"/> <input type="text"/>
12. 收縮壓 (mmHg) Systolic blood pressure (mmHg)	<input type="text"/> <input type="text"/> <input type="text"/>
13. 舒張壓 (mmHg) Diastolic blood pressure (mmHg)	<input type="text"/> <input type="text"/> <input type="text"/>

兒童青少年（學生：6~22歲） - 大學生
Children and Adolescents (Students aged 6~22) - University Students

14.肺活量 (ml) Vital capacity (ml)	<input type="text"/> <input type="text"/> <input type="text"/> <input type="text"/>
15.引體向上 (次) (男) / 一分鐘仰臥起坐 (次) (女) Pull-ups (times) (M) / One-minute sit-ups (times) (F)	<input type="text"/> <input type="text"/> <input type="text"/>
16.立定跳遠 (cm) Standing long jump (cm)	<input type="text"/> <input type="text"/> <input type="text"/>
17.50米跑 (秒) 50m run (sec)	<input type="text"/> <input type="text"/> . <input type="text"/>
18.1000米跑 (秒) (男) / 800米跑 (秒) (女) 1000m run (sec) (M) / 800m run (sec) (F)	<input type="text"/> <input type="text"/> <input type="text"/> . <input type="text"/>
19.握力 (kg) Grip strength (kg)	<input type="text"/> <input type="text"/> . <input type="text"/>
20.縱跳 (cm) Vertical jump (cm)	<input type="text"/> <input type="text"/> . <input type="text"/>
21.背力 (kg) Back strength (kg)	<input type="text"/> <input type="text"/> <input type="text"/>
22.坐位體前屈 (cm) Sit and reach (cm)	<input type="text"/> <input type="text"/> <input type="text"/> . <input type="text"/>
23.閉眼單腳站立 (秒) One foot stands with eyes closed (OFSEC) (sec)	<input type="text"/> <input type="text"/> <input type="text"/>
24.選擇反應時 (秒) Choice reaction time (sec)	<input type="text"/> . <input type="text"/> <input type="text"/>

2020年澳門市民體質監測數據登錄冊

Data Registration Manual of
2020 Physical Fitness Study of Macao SAR Residents

26.視力 Vision			
裸眼視力 Naked eyes	左 Left	<input type="text"/>	右 Right
串鏡校正 Refractive error correction	左 Left	正片 Positive lens	_____
		負片 Negative lens	_____
串鏡校正 Refractive error correction	右 Right	正片 Positive lens	_____
		負片 Negative lens	_____
屈光不正 Refractive errors	左 Left	<input type="checkbox"/>	右 Right
(0) 正常 Normal	(1) 近視 Nearsighted	(2) 遠視 Farsighted	(3) 其他 Others
27.色覺檢查 Color vision deficiency exam			<input type="checkbox"/>
(1) 正常 Normal	(2) 不正常 Abnormal		

檢驗員簽署：

Examiner Signature : _____

III. Adults

1. Adults (aged 20~39)





歡迎閣下參加2020年澳門市民體質監測！澳門市民體質監測是特區政府為推動大眾健身活動的開展而進行的調查研究。在此首先感謝閣下對監測的支持並認真、如實地填寫問卷，我們保證對閣下的個人資料保密，有關資料不會獨立出現或使用，它將是整體數據的組成部分。再次對閣下的真誠參與表示感謝！

如對調查內容和檢測項目有任何疑問，歡迎向體育局運動醫學中心垂詢！

電話：28810896，88934540

Thank you for participating in our 2020 Physical Fitness Study! This study is organized by the Macao SAR Government to promote Sports for All. We are grateful for your participation. Your honesty and sincerity in filling out the questionnaire are appreciated. We promise to keep your personal data confidential and we will not publish or use your data individually. It will only be used as part of the whole study for statistical purposes. Again, we would like to extend our most sincere gratitude for your participation!

For any enquiries regarding the questionnaire or testing items, please feel free to contact Sports Medicine Centre of Macao Sports Bureau!
Telephone: 28810896, 88934540

2020年澳門市民體質監測數據登錄冊

Data Registration Manual of
2020 Physical Fitness Study of Macao SAR Residents

體育局轄下運動醫學中心預先聲明

Declaration
Sports Medicine Centre of Macao Sports Bureau

本聲明旨在向個人資料當事人或相關家長或監護人確保遵守第8/2005號法律“個人資料保護法”所規範的事宜。

This declaration is intended to assure data subjects or their parents or guardians that we will strictly comply with the relevant provisions of Act 8/2005 - Personal Data Protection Act.

1. 處理個人資料的負責人—體育局，地址設於澳門羅理基博士大馬路818號。代表—體育局局長。

Personal data controller: Macao Sports Bureau, at Av. Dr. Rodrigo Rodrigues, n.º 818, Macao.
Representative - President of Macao Sports Bureau.

2. 處理個人資料的目的—進行澳門市民體質監測，以便為制定日後關於體育及醫療護理的政策提供科學數據。收集的數據旨在更新僅為統計用途的數據庫。

Purposes of processing personal data: To conduct the physical fitness study for Macao residents, and provide scientific references for the development of relevant policies regarding sports and medical care. Data collected through the physical fitness study will only be used to update the database for statistical purposes.

3. 個人資料當事人類別—參與是次計劃的澳門居民（隨年齡抽樣）。

Categories of subjects with personal data: Macao residents participated in the study (random sampling by age).

4. 個人資料接收者—個人資料當事人（或相關家長或監護人），運動醫學中心及國家體育總局體育科學研究所。

Personal data recipients: Data subjects (or their parents or guardians), Sports Medicine Centre and China Institute of Sport Science.

5. 接收及處理個人資料的條件—個人資料當事人（或相關家長或監護人）享有第8/2005號法律賦予的所有權利如查閱權及更正所收集的個人資料。運動醫學中心承諾對不正確的數據進行更正，刪除或封鎖。

Conditions of receiving and processing personal data: Data subjects (or their parents or guardians) are entitled by Act 8/2005 - Personal Data Protection Act to the rights to access and rectify their own personal data collected. The Sports Medicine Centre hereby commits to take proper measures to rectify, delete or block any incorrect data.

成年人(20~39歲)
Adults (aged 20~39)

6.處理個人資料的安全和保密性—對處理及編輯個人資料絕對保密及採取適當措施以確保其安全。

Security and confidentiality of processing personal data: Appropriate measures are implemented to process and edit the personal data to ensure strict confidentiality, safety and security of the data.

本人已明白上述內容權益

I, the undersigned, am aware of the contents and my legal rights in the above declaration.

(個人資料當事人或家長或監護人簽名)
(Signature of subject providing personal
data/parents/guardian)

_____/_____/_____
(日) (月) (年)
(DD) (MM) (YY)

姓名：	_____
Name:	_____
性別：	_____
Gender:	_____
年齡：	_____ (周歲)
Age:	_____ (years)
工作單位：	_____
Work unit:	_____
聯繫電話：	_____
Phone:	_____

2020年澳門市民體質監測數據登錄冊

Data Registration Manual of
2020 Physical Fitness Study of Macao SAR Residents

一.分類編碼 General Information

填寫方法：

填寫選擇題時請將選擇答案的序號填入相應的方格中，如選答案（1），則在方格內填1；序號為兩位數時，兩位數字填入同一方格，如選項為（11），則將 填入同一方格，即填為 。在填寫多項選擇題時，如果僅選擇一個或兩個答案，則應在剩餘方格內填0。

Instructions for filling:

Please fill in the boxes with the corresponding numbers. For example, if the chosen answer is (1), fill in the box with "1". If the chosen option is a two digit number, write both digits in the same box. e.g. If the chosen option is (11), fill in the box with . For multiple choice questions, if only one or two option(s) were chosen, please fill in the remaining blank box(es) with "0".

1.澳門居民身份證號碼 Macao ID card number	<input type="text"/> <input type="text"/> <input type="text"/> <input type="text"/> <input type="text"/> <input type="text"/> <input type="text"/> <input type="text"/>					
2.性別 Gender	(1) 男 Male	(2) 女 Female	<input type="text"/>			
3.出生日期 Date of birth	<input type="text"/> <input type="text"/> <input type="text"/> <input type="text"/>	年 Y	<input type="text"/> <input type="text"/>	月 M	<input type="text"/> <input type="text"/>	日 D
4.測試日期 Examination date	<input type="text"/> <input type="text"/> <input type="text"/> <input type="text"/>	年 Y	<input type="text"/> <input type="text"/>	月 M	<input type="text"/> <input type="text"/>	日 D
5.工作單位代碼（由監測人員填寫） Work unit code number (filled in by examiner)	<input type="text"/> <input type="text"/> <input type="text"/> <input type="text"/>					
6.測試序號（由監測人員填寫） Serial number (filled in by examiner)	<input type="text"/> <input type="text"/> <input type="text"/> <input type="text"/>					
7.居住在澳門的年限（年）（指連續在澳門居住的年限，如果離開澳門的時間超過1年，則要由回澳門居住起重新計算居澳年限） Years of residence in Macao (It refers to years of continuous residence in Macao. If you had left Macao for over 1 year, years of residence in Macao should be recalculated from the time of returning to Macao.)	<input type="text"/> <input type="text"/>					

成年人(20~39歲)
Adults (aged 20~39)

<p>8. 日常主要勞作方式 Labor intensity of daily work</p> <p>(1) 以靜坐伏案等靜態性活動為主 (如用電腦、書寫等) Mainly sedentary work (such as computer use, paperwork, etc.)</p> <p>(2) 日常勞作中以靜坐伴有上肢活動，或大部份時間多以站立或走動為主 (如計程車司機、售貨員、流水線組裝工等) Mainly work done seated with upper limb movements, or standing or walking during most of the work time (such as taxi drivers, sales personnel, assembly line workers, etc.)</p> <p>(3) 日常勞作中主要從事重體力性活動、搬運或舉重物、挖掘等 (如建築工人等) Mainly heavy physical activities, manual load handling or lifting, digging, etc. (such as construction workers, etc.)</p>	<input type="checkbox"/>
<p>9. 出生地 Place of birth</p> <p>(1) 中國大陸 (2) 澳門 (3) 香港 (4) 葡萄牙 (5) 其他 Mainland China Macao Hong Kong Portugal Others</p>	<input type="checkbox"/>
<p>10. 居住地所屬堂區 Parish of residence</p> <p>(1) 聖方濟各堂區 (路環) Paróquia de São Francisco Xavier (Coloane)</p> <p>(2) 聖嘉模堂區 (氹仔) Paróquia de Nossa Senhora do Carmo (Taipa)</p> <p>(3) 風順堂區 (包括媽閣山、西望洋山、下環及內港一帶) Paróquia de S. Lourenço (Zonas das Colinas da Barra e da Penha, da Praia do Manduco e do Porto Interior)</p> <p>(4) 大堂區 (新馬路一帶、南灣、水坑尾、新口岸南北地段及南灣湖發展區) Paróquia da Sé Catedral (Zonas da Almeida Ribeiro, da Praia Grande, da Rua do Campo, dos Lotes norte e sul do Porto Exterior e da Zona do Lago Nam Van)</p> <p>(5) 花王堂區 (聖安多尼堂區，在澳門西部，包括高士德大馬路、新橋和沙梨頭) Paróquia de Santo António (Zonas da Freguesia de Santo António, do Oeste de Macau, incluindo Av. Horta e Costa, de San Kiu e do Patane)</p> <p>(6) 望德堂區 (包括荷蘭園、松山一帶) Paróquia de S. Lázaro (Zona do Conselheiro Ferreira de Almeida e da Colina da Guia)</p> <p>(7) 花地瑪堂區 (俗稱北區，包括青洲、台山、黑沙環、筷子基和水塘) Paróquia de Nossa Senhora de Fátima (Zonas do Norte, incluindo Ilha Verde, Tamagnini Barbosa, Areia Preta, Fái Chi Kei e Reservatório)</p>	<input type="checkbox"/>

2020年澳門市民體質監測數據登錄冊

Data Registration Manual of
2020 Physical Fitness Study of Macao SAR Residents

<p>11. 學歷 Education level</p> <p>(1) 小學程度以下 Below primary school education</p> <p>(2) 小學 Primary school</p> <p>(3) 中學 Secondary school</p> <p>(4) 專上教育 Post-secondary education</p> <p>(5) 碩士 Master</p> <p>(6) 博士 Doctoral</p>	<input type="checkbox"/>
<p>12. 目前主要從事的職業 Current occupation</p> <p>(1) 立法機關成員、公共行政高級官員、社團領導人員及經理 Legislative officer, public administration officer, community leader or manager</p> <p>(2) 專業人員（各學科領域之專業工作者，也包括高等教育及中學教學人員） Professional (professionals in various disciplines including higher education and secondary school teaching staff)</p> <p>(3) 技術員及輔助專業人員（各學科領域中主要從事技術操作工作，也包括幼教、小學及特殊教育教師） Technician or professional assistant (persons who engaged in technical works in various disciplines including preschool, primary school and special education teachers)</p> <p>(4) 文員（包括秘書、文書工作文員、出納員、接待員、票務員及同類工作人員） Office clerk (secretaries, secretarial work office clerks, cashiers, receptionists, ticket agents and workers of similar nature)</p> <p>(5) 服務、銷售及同類工作人員（如從事旅遊、餐飲、美容、保險等服務之工作人員，也包括消防員、交通及治安警察人員、保安員、售貨人員等） Customer service, sales representative or similar nature (persons who engaged in tourism, catering, beauty care, insurance, and also including firefighters, traffic and public security police officers, security staff, sales personnel etc.)</p> <p>(6) 漁農業熟練工作者（如漁民、農夫、儲藏及銷售漁農業及畜牧業產品等人員） Skilled worker in the fishery or agricultural field (fisher folks, farmers, and persons who engaged in storing and selling of fishery, agricultural, and livestock products etc.)</p> <p>(7) 工業工匠及手工藝工人（包括建築工人及手工業製作工人） Artisan or craftsperson (including construction workers and handicraft workers)</p> <p>(8) 機台、機器操作員、司機及裝配員 Machine operator, driver or assembler</p> <p>(9) 非技術工人（如清潔員、管理員、信差、搬運工人） Non-technician (e.g. cleaners, property management officers, postpersons, porters)</p> <p>(10) 其他 Others</p> <p>(11) 待業 Unemployed</p> <p>(12) 家庭主婦/夫 housewife/househusband</p>	<input type="checkbox"/>

成年人(20~39歲)
Adults (aged 20~39)

<p>13.近5年曾患過何種疾病（經醫院確診的疾病）（選擇“無”者請直接回答問題第15題） Any hospital-diagnosed diseases suffered within the past 5 years? (If the answer is “no”, skip to Question 15)</p>			<input type="checkbox"/>
<p>(1) 有 (2) 無 Yes No</p>			
<p>14.患病種類（患病者按主次順序，最多可填寫3項） Diseases suffered (in order of precedence, choose up to 3 diseases)</p>			<input type="text"/> <input type="text"/> <input type="text"/>
(1) 急性支氣管炎 Acute bronchitis	(2) 肺炎 Pneumonia	(3) 腸炎、胃炎 Enteritis, gastritis	
(4) 胃潰瘍 Gastric ulcer	(5) 咽喉炎 Pharyngitis	(6) 鼻炎 Rhinitis	
(7) 中耳炎 Otitis media	(8) 結膜炎、乾眼症 Conjunctivitis, dry eye syndrome	(9) 牙周炎 Periodontitis	
(10) 膽結石、慢性膽囊炎 Gallstone, chronic cholecystitis	(11) 過敏性皮炎 Allergic dermatitis	(12) 腳癬 Tinea pedis	
(13) 尿道炎 Urethritis	(14) 陰道炎、宮頸炎 Coleitis, cervicitis	(15) 風疹、麻疹、水痘 Rubella, measles, varicella	
(16) 貧血 Anemia	(17) 糖尿病 Diabetes	(18) 高血脂 Hyperlipemia	
(19) 高血壓 Hypertension	(20) 心臟病 Heart disease	(21) 腦卒中 Cerebral stroke	
(22) 腫瘤 Tumor	(23) 類風濕性關節炎 Rheumatoid arthritis	(24) 椎間盤疾病 Discopathy	
(25) 腎炎 Nephritis	(26) 肝炎 Hepatitis	(27) 長期失眠 Long-term insomnia	
(28) 意外傷害(造成人體的損傷而需要醫治或影響了正常的活動) Accidental injury (injury to the body that needs treatments, or injury that affects normal activities)		(29) 其他 Others	
<p>15.在此之前，是否聽說過“體質測定” Have you ever heard of the “Physical Fitness Study”?</p>			<input type="checkbox"/>
<p>(1) 是 (2) 否 Yes No</p>			
<p>16.在此之前，是否參加過“體質測定” Have you ever participated in the “Physical Fitness Study”?</p>			<input type="checkbox"/>
<p>(1) 是 (2) 否 Yes No</p>			

2020年澳門市民體質監測數據登錄冊

Data Registration Manual of
2020 Physical Fitness Study of Macao SAR Residents

17. 對“體質測定”的認識（按照主次順序，最多選3項）

What is your understanding of the “Physical Fitness Study”?
(in order of precedence, at most 3 options)

--	--	--

(1) 無意義

Meaningless

(2) 瞭解自己的體質狀況

To understand the physical fitness status of oneself

(3) 認識體育鍛煉的重要性

To recognize the importance of physical exercising

(4) 增長科學健身知識

To improve knowledge of scientific fitness

成年人(20~39歲)
Adults (aged 20~39)

二、健身素養問卷 Fitness Literacy

A-知識、認知和態度 Knowledge, cognition and attitude

A1. 【單選題】您認為以下說法是否正確，正確選1、不正確選2、不知道選3，並在您選的數字上畫“○”。

【Which of the following descriptions do you think are correct? Choose 1 for “Correct”, 2 for “Incorrect”, 3 for “Don’t know”, and circle each corresponding number with “○”.

題目 Question	正確 Correct	不正確 Incorrect	不知道 Don't know
1) 清晨是鍛煉的最佳時間 Morning is the best time for physical exercise.	1	2	3
2) 大強度運動有利於減肥 High-intensity exercise is good for losing weight.	1	2	3
3) 吃飯後需要休息約30分鐘再去散步 A 30 minute rest is needed after eating before going for a walk.	1	2	3
4) 跑步應該選擇堅硬平坦的地面 Choose hard and flat ground when running.	1	2	3
5) 跳繩可以預防骨質疏鬆 Rope skipping can prevent osteoporosis.	1	2	3
6) 體育鍛煉時最好穿純棉服裝 It is best to wear pure cotton clothing when exercising.	1	2	3
7) 游泳後不能立刻吃東西 Don't eat right after swimming.	1	2	3
8) 運動處方是指針對某一類人群的身體狀況，採用處方的形式規定健身者鍛煉的內容和運動量的方法 Exercise prescription is used to specify the content and amount of exercise in the form of prescription, according to the physical condition of a targeted group.	1	2	3
9) 腹式呼吸是指開始吸氣時全身用力，此時胸部及腹部會充滿空氣而鼓起，然後用力將氣吐出 Abdominal breathing refers to the breathing method of inhaling deeply to fill the chest and bulging belly with air, and then exhaling deeply.	1	2	3
10) 有氧運動是人體在氧氣充分供應的情況下進行運動強度低、運動時間較長且富韻律性的體育鍛煉，如游泳、慢跑 Aerobic exercise is a kind of rhythmic exercise that is low intensity and long duration under the condition of sufficient oxygen supply, such as swimming and jogging.	1	2	3

2020年澳門市民體質監測數據登錄冊

Data Registration Manual of
2020 Physical Fitness Study of Macao SAR Residents

A2. 【單選題】以下說法您是否同意，非常不贊同選1、不太贊同選2、一般選3、比較贊同選4、非常贊同選5，並在您選的數字上畫“○”。

【Single choice question】 Which of the following descriptions do you agree with? Choose 1 for “Strongly disagree”, 2 for “Slightly disagree”, 3 for “Neutral”, 4 for “Relatively agree”, 5 for “Strongly agree”, and circle each corresponding number with “○”.

題目 Question	非常不贊同 Strongly disagree	不太贊同 Slightly disagree	一般 Neutral	比較贊同 Relatively agree	非常贊同 Strongly agree
1) 總體來評價，健身活動是一項積極向上的活動 Generally speaking, fitness activity is an activity that is positive.	1	2	3	4	5
2) 健身活動有益於保持身體健康 Fitness activity is good for body health.	1	2	3	4	5
3) 健身活動可以舒緩焦慮、煩躁的情緒 Fitness activity can relieve anxiety or irritability.	1	2	3	4	5
4) 健身活動可以增強人的意志 Fitness activity can hone the will.	1	2	3	4	5
5) 健身活動是無趣的 Fitness activity is boring.	1	2	3	4	5
6) 健身活動是非常值得去做的活動 Fitness activity is well worth doing.	1	2	3	4	5
7) 健身是我生活中可以缺少的一部分 Exercising is a part of my life that I can live without.	1	2	3	4	5
8) 不管多忙，都應該抽時間去健身 We should spare time for exercising no matter how busy we are.	1	2	3	4	5
9) 把錢花在健身方面是值得的 Spending money on exercising is worthwhile.	1	2	3	4	5
10) 我願意說服周圍的人同我一起健身 I would like to persuade others to work out with me.	1	2	3	4	5

成年人(20~39歲)
Adults (aged 20~39)

A3. 【單選題】下面的說法是否符合您的實際情況？非常不符合選1、不太符合選2、一般選3、比較符合選4、非常符合選5，並在您選的數字上畫“○”。

[Single choice question] Which of the following descriptions is accurate according to your situation? Choose 1 for “Very inconsistent”, 2 for “Not quite consistent”, 3 for “Neutral”, 4 for “Slightly consistent”, 5 for “Very consistent”, and circle each corresponding number with “○”.

題目 Question	非常不符合 Very inconsistent	不太符合 Not quite consistent	一般 Neutral	比較符合 Slightly consistent	非常符合 Very consistent
1) 我已經掌握的體育鍛煉技能是正確的、科學的 I think the exercising skills that I have acquired are correct and scientific.	1	2	3	4	5
2) 已經或正準備去瞭解、諮詢一下體育健身的專業人士（如體育老師、健身教練、電視節目），聽一下他們的專業意見 I have visited or am planning to consult with sports and fitness professionals (e.g., PE teachers, fitness coaches, TV shows) and get their professional advice.	1	2	3	4	5

2020年澳門市民體質監測數據登錄冊

Data Registration Manual of
2020 Physical Fitness Study of Macao SAR Residents

B-健身技能 Fitness skills

B1. 【多選排序題】體育鍛煉的主要項目有哪些？本題為多選題，可選1個或1個以上的答案，請圈選所有您主要參加的體育鍛煉項目，在選項對應的序號上畫“○”，並按照經常參加的頻率由高到低排序後將對應序號填寫如下：、、、、、、。如果沒有參加過任何運動項目只圈選33即可。

【Multiple-choice sorting question】What are the physical exercises in which you frequently participated? This is a multiple choice question, you need to choose at least 1 or more option(s). Choose the physical exercises you have frequently participated, circle the corresponding number with “○”, and fill in the blanks in descending order of frequency as follows: , , , , , , . If your answer is “None”, circle the number 33.

1	步行（健步走） Walking (Brisk walking)	12	門球、地擲球 Gate ball, bocce ball	23	騎自行車 Cycling
2	跑步 Running	13	高爾夫球 Golf	24	瑜伽、普拉提 Yoga, Pilates
3	跳高 High jump	14	柔力球 Softball	25	力量、健美（徒手、器械） Strength exercises, body building (bodyweight training, equipment workout)
4	跳遠 Long jump	15	健身操類（體操、健美操等） Aerobics (such as gymnastics, aerobics, etc.)	26	滑冰 Skating
5	登山、攀岩 Hiking, rock climbing	16	舞蹈類（廣場舞、民族舞等） Dancing (such as square dance, folk dance, etc.)	27	滑雪 Skiing
6	籃球 Basketball	17	武術（武術套路、太極、木蘭等） Martial arts (such as series of skills, taiji, mulan, etc.)	28	游泳 Swimming
7	排球 Volleyball	18	健身氣功（易筋經、八段錦、五禽戲、 六字訣等） Qigong (such as yijinjing, baduanjin, wuqinxi, liuzijue, etc.)	29	跳繩 Rope skipping
8	足球 Football	19	拳擊、摔跤、散打 Boxing, wrestling, free combat	30	踢毽 Shuttlecock kicking
9	網球 Tennis	20	跆拳道 Taekwondo	31	輪滑 Roller skating
10	乒乓球 Table tennis	21	空手道 Karate	32	其他 Other
11	羽毛球 Badminton	22	柔道 Judo	33	沒有參加過任何運動項目 （不用回答B2、C1題） None (skip Questions B2, C1)

成年人(20~39歲)
Adults (aged 20~39)

B2. 【多選排序題】您能夠熟練掌握的體育鍛煉項目有哪些（熟練是指自己能掌握某項運動的基本技能和基本比賽規則）？本題為多選題，可選1個或1個以上的答案，請圈選所有您熟練掌握的運動項目，在選項對應的序號上畫“○”，並按照熟練程度排序後將對應序號填寫如下：、、、、、、、、。如果沒有熟練掌握的項目只圈選33即可。

【Multiple-choice sorting question】What kinds of physical exercises are you proficient at (Proficiency means that you have acquired the basic skills and basic competition rules of the exercise)? This is a multiple choice question, you need to choose at least 1 or more option(s). Choose all the physical exercises in which you are proficient at, circle the corresponding number with “○”, and fill in the blanks in descending order of proficiency as follows: , , , , , , , , . If your answer is “None”, circle the number 33.

1	步行（健步走） Walking (Brisk walking)	12	門球、地擲球 Gate ball, bocce ball	23	騎自行車 Cycling
2	跑步 Running	13	高爾夫球 Golf	24	瑜伽、普拉提 Yoga, Pilates
3	跳高 High jump	14	柔力球 Softball	25	力量、健美（徒手、器械） Strength exercises, body building (bodyweight training, equipment workout)
4	跳遠 Long jump	15	健身操類（體操、健美操等） Aerobics (such as gymnastics, aerobics, etc.)	26	滑冰 Skating
5	登山、攀岩 Hiking, rock climbing	16	舞蹈類（廣場舞、民族舞等） Dancing (such as square dance, folk dance, etc.)	27	滑雪 Skiing
6	籃球 Basketball	17	武術（武術套路、太極、木蘭等） Martial arts (such as series of skills, taiji, mulan, etc.)	28	游泳 Swimming
7	排球 Volleyball	18	健身氣功（易筋經、八段錦、五禽戲、 六字訣等） Qigong (such as yijinjing, baduanjin, wuqinxi, liuzijue, etc.)	29	跳繩 Rope skipping
8	足球 Football	19	拳擊、摔跤、散打 Boxing, wrestling, free combat	30	踢毽 Shuttlecock kicking
9	網球 Tennis	20	跆拳道 Taekwondo	31	輪滑 Roller skating
10	乒乓球 Table tennis	21	空手道 Karate	32	其他 Other
11	羽毛球 Badminton	22	柔道 Judo	33	沒有熟練掌握的項目 None

2020年澳門市民體質監測數據登錄冊

Data Registration Manual of
2020 Physical Fitness Study of Macao SAR Residents

B3. 【多選題】 您知道運動前要做的準備活動有哪些？本題為多選題，可選1個或1個以上的答案，請圈選所有您知道的準備活動，在選項對應的序號上畫“○”。如果沒有知道的準備活動只圈選10即可。）

【Multiple choice question】 What kinds of warm-up exercises should be done before exercising? This is a multiple choice question, you need to choose at least 1 or more option(s). Choose all the warm-up exercises you know, and circle each corresponding number with “○”. If your answer is “None”, circle the number 10.

1	慢跑 Jogging	6	壓腿（包括前壓腿和側壓腿） Leg stretch (including forward lunge stretch and side lunge stretch)
2	腰部運動（如扭腰） Waist movement (such as waist twisting)	7	體前屈 Forward bend
3	肩部運動（轉動肩膀） Shoulder movement (rolling shoulders)	8	原地高抬腿 High-knee running in place
4	關節活動（包括手腕關節、頸關節和腳踝關節） Joint movement (including wrist, neck and ankle joints)	9	其他 Others
5	擴胸運動 Chest expansion exercise	10	沒有知道的準備活動（不用回答B4題） None (skip Question B4)

B4. 【多選題】 您能夠熟練掌握的準備活動有哪些（熟練是指自己獨立會做某項準備活動）？本題為多選題，可選1個或1個以上的答案，請圈選所有您熟練掌握的準備活動，在選項對應的序號上畫“○”。如果沒有熟練掌握的準備活動只圈選10即可。

【Multiple choice question】 What kinds of warm-up exercises are you proficient at (Proficiency means that you would conduct the warm-up exercise when on your own)? This is a multiple choice question, you need to choose at least 1 or more option(s). Choose all the warm-up exercises in which you are proficient at, and circle each corresponding number with “○”. If your answer is “None”, circle the number 10.

1	慢跑 Jogging	6	壓腿（包括前壓腿和側壓腿） Leg stretch (including forward lunge stretch and side lunge stretch)
2	腰部運動（如扭腰） Waist movement (such as waist twisting)	7	體前屈 Forward bend
3	肩部運動（轉動肩膀） Shoulder movement (rolling shoulders)	8	原地高抬腿 High-knee running in place
4	關節活動（包括手腕關節、頸關節和腳踝關節） Joint movement (including wrist, neck and ankle joints)	9	其他 Others
5	擴胸運動 Chest expansion exercise	10	沒有熟練掌握的準備活動 None

成年人(20~39歲)
Adults (aged 20~39)

B5. 【單選題】下面的說法是否符合您的實際情況？非常不符合選1、不太符合選2、一般選3、比較符合選4、非常符合選5，並在您選的數字上畫“○”。

【Single choice question】 Which of the following descriptions is accurate according to your situation? Choose 1 for “Very inconsistent”, 2 for “Not quite consistent”, 3 for “Neutral”, 4 for “Slightly consistent”, 5 for “Very consistent”, and circle each corresponding number with “○”.

題目 Question	非常不符合 Very inconsistent	不太符合 Not quite consistent	一般 Neutral	比較符合 Slightly consistent	非常符合 Very consistent
1) 能夠結合自己的情況選擇適合自己的體育鍛煉項目 I can choose physical exercises that suit me.	1	2	3	4	5
2) 能夠根據自身狀況合理的制定健身計劃 I can reasonably develop a fitness plan based on my actual condition.	1	2	3	4	5
3) 能夠根據實際情況及時對健身計劃作出調整 I can promptly adjust my fitness plan based on my actual condition.	1	2	3	4	5

B6. 【單選題】下面的說法是否符合您的實際情況？非常不符合選1、不太符合選2、一般選3、比較符合選4、非常符合選5，並在您選的數字上畫“○”。

【Single choice question】 Which of the following descriptions is accurate according to your situation? Choose 1 for “Very inconsistent”, 2 for “Not quite consistent”, 3 for “Neutral”, 4 for “Slightly consistent”, 5 for “Very consistent”, and circle each corresponding number with “○”.

題目 Question	非常不符合 Very inconsistent	不太符合 Not quite consistent	一般 Neutral	比較符合 Slightly consistent	非常符合 Very consistent
1) 對於喜歡的健身項目，您認為已經很好地掌握了該健身項目所要求的技能 I think I have adequately acquired the skills of exercises that I like.	1	2	3	4	5
2) 只要自己願意，您可以堅持進行健身活動 I can persist in exercising if I want to.	1	2	3	4	5

2020年澳門市民體質監測數據登錄冊

Data Registration Manual of
2020 Physical Fitness Study of Macao SAR Residents

C-習慣養成 Habit formation

C1. 【單選題】 您是如何選中B1題中的這些體育鍛煉項目的？請在您選中的選項對應的序號上畫“○”。

【Single choice question】 How did you choose the physical exercises in Question B1? Choose the proper answer and circle its corresponding number with “○”.

1	自己隨便選的 I chose them randomly	4	跟著家人、朋友或同事等選的 I followed the choices of my family members, friends or colleagues.
2	哪些項目練起來方便就選哪些 I chose them because they are convenient to do.	5	哪些項目容易就選哪些 I chose them because they are easy to do.
3	跟著潮流走的 Follow the general trend.	6	諮詢過專業意見 I chose them after seeking for professional advice.

C2. 【限選排序題】 阻礙您開展體育鍛煉的原因是甚麼？本題為限選排序題，請圈選出3個對您來說最主要的原因，在選項對應的序號上畫“○”，並依據重要程度由高到低進行排序後將序號依次填寫在以下方框上：、、。

【Three-choice sorting question】 What are the main obstacles to your participation in physical exercise? This is a three-choice sorting question, choose the top 3 reasons, circle each corresponding number with “○”, and fill in the blanks in order of precedence as follows: , , .

1	工作忙 Busy work	7	沒有健身場地 Lack of suitable venues
2	家務忙 Too many house chores	8	健身場地距離太遠 Lack of fitness venues nearby
3	怕受傷 To avoid physical injury	9	周邊缺少體育健身組織 Lack of fitness clubs nearby
4	經濟條件不允許 Financial restraint	10	群眾性的健身賽事或者活動太少 Lack of events or activities for residents
5	對體育鍛煉沒有興趣 Lack of interest	11	社區組織開展的活動項目少，缺乏吸引力 Lack of such activities in community, or activities less attractive
6	不知道該怎麼鍛煉，缺乏指導 Lack of coaching advice	12	其他 Others

成年人(20~39歲)
Adults (aged 20~39)

- C3. 【單選題】您現在的工作狀態（是指您的職業活動，含義工或志願者工作但不包含家庭主婦/夫所從事的家務工作）如何？請在您選中的選項對應的序號上畫“○”，如果選擇1則同時填寫方框的內容。

【Single choice question】 What is your current work status (i.e. your profession's activities, including volunteer work, but not including house chores conducted as housewives/husbands)? Choose the proper answer and circle its corresponding number with “○”, If you choose Option 1, fill in the blanks with answers.

1	每週工作 <input type="text"/> 天，平均每天工作 <input type="text"/> 小時 I work <input type="text"/> days per week, <input type="text"/> hours per day.
2	有工作但不定時 No regular work
3	不工作（不用回答C4題） Unemployed (skip Question C4)

- C4. 【填空題】您工作中的體力活動狀況如何？請認真讀題後，在“”處填寫您的實際情況，如果沒有以下情況的請填“0”。注：填寫時間通常為10的倍數。

【Blank-filling question】 What is the labor intensity of your daily work? Read the question carefully, and fill in the blanks “” according to your actual conditions. If it is not applicable, write “0”. Note: The number you fill in should be a multiple of 10.

- 1) 您的工作中通常每週有多少天會做“呼吸和心跳顯著增加（如搬運或舉重物、挖掘或建築工作等）”持續時間10分鐘以上的劇烈活動？天；您通常一天工作中累計做多長時間的這種持續10分鐘以上的劇烈活動？分鐘。

How many days in a typical week at work do you do vigorous activities (e.g. manual load handling or lifting, digging or construction work) lasting for more than 10 minutes with “significantly increased breathing and heart rate”? days; What is the average cumulative time you spent on doing such vigorous activities lasting for more than 10 minutes at work in a typical day? minutes.

- 2) 您的工作中通常每週有多少天會做“呼吸和心跳輕度增加（如快步走、搬運較輕的物品）”持續時間10分鐘以上的中等強度活動？天；您通常一天工作中累計做多長時間的這種持續10分鐘以上的中等強度活動？分鐘。

How many days in a typical week at work do you do moderate-intensity activities (e.g. brisk walking, manual handling of light objects) lasting for more than 10 minutes with “slightly increased breathing and heart rate”? days; What is the average cumulative time you spent doing such moderate-intensity activities lasting for more than 10 minutes at work in a typical day? minutes.

- C5. 【填空題】您通常每天有多少時間坐著或者靠著？注：填寫分鐘通常為10的倍數。

【Blank-filling question】 What is your average sitting or reclining time per day? Note: The number you fill in should be a multiple of 10.

請填寫：小時分鐘。
Please fill in the blanks: hours minutes

2020年澳門市民體質監測數據登錄冊

Data Registration Manual of
2020 Physical Fitness Study of Macao SAR Residents

C6. 【填空題】您通常每天睡眠（包括午睡）多少時間？注：填寫分鐘通常為10的倍數。

【Blank-filling question】 What is your average sleep time (including naps) per day? Note: The number you fill in should be a multiple of 10.

請填寫： 小時 分鐘。
Please fill in the blanks: hours minutes

C7. 【單選題】您通常最主要的交通出行方式是甚麼？請在您選中選項對應的序號上畫“○”。

【Single choice question】 What is your major means of transportation? Choose the proper answer and circle its corresponding number with “○”.

1	步行 On foot	4	駕車 Driving
2	騎自行車 Bicycling	5	乘公共交通、乘坐私家車或乘坐電單車等 By public transport, private car or motorcycle
3	騎電單車 Motorcycling	6	其他 Others

C8. 【填空題】您通常每週有多少天的出行交通方式為步行或騎自行車持續時間10分鐘以上（出行指的是去上班、購物、參加聚會等，但不包括專為體育鍛煉而進行的步行或者騎行。）？天；您通常一天在交通方面累計花多長時間這種持續10分鐘以上的步行或者騎自行車？分鐘。注：填寫時間通常為10的倍數；如果沒有這種情況的請填“0”。

【Blank-filling question】 How many days do you walk or bicycle for at least 10 minutes continuously in a typical week (It refers to the total time spent commuting to work, shopping and attending parties, etc., but do not include walking or bicycling specifically for exercising)? days; What is the average cumulative commuting time you spent walking or bicycling at least 10 minutes continuously in a typical day? minutes. Note: The number you fill in should be a multiple of 10; if it is not applicable, write “0”.

C9. 【填空題】您在做家務過程中的體力活動狀況如何？請認真讀題後，在“”處填寫您的實際情況，如果沒有以下情況的請填“0”。注：填寫時間通常為10的倍數。

【Blank-filling question】 What is the labor intensity of your daily house chores? Read the question carefully, and fill in the blanks “” according to your actual conditions. If it is not applicable, write “0”. Note: The number you fill in should be a multiple of 10.

1) 您生活中通常每週有多少天會從事持續時間10分鐘以上、大強度的家務勞動（比如搬提重物、庭院挖土等）？天；平均一天累計會做多長時間這種持續10分鐘以上的大強度家務勞動？分鐘。

How many days in a typical week do you do high-intensity house chores (e.g. manual load handling or lifting, digging in the yard, etc.) lasting for more than 10 minutes?

days; What is the average cumulative time you spent doing such high-intensity house chores lasting for more than 10 minutes in a typical day? minutes

成年人(20~39歲)
Adults (aged 20~39)

- 2) 您生活中通常每週有多少天會從事持續時間10分鐘以上、中等強度的家務勞動(比如搬提輕物、擦窗、擦地、打掃房間等)? 天; 平均一天累計會做多長時間這種持續10分鐘以上的中等強度家務勞動? 分鐘。

How many days in a typical week do you do moderate-intensity house chores (e.g. handling or lifting light objects, wiping the window, mopping the floor, cleaning the room, etc.) lasting for more than 10 minutes? days; What is the average cumulative time you spent doing such moderate-intensity house chores lasting for more than 10 minutes in a typical day? minutes

- C10. 【限選排序題】請問您通常會從事哪些閒暇活動? 本題為限選排序題, 請圈選出3件最經常做的事, 在選項對應的序號上畫“○”, 並依據花費時間由長到短進行排序後將序號依次填寫在以下方框上: 、、。

【Three-choice sorting question】What leisure-time activities do you usually do? This is a three-choice sorting question, choose the top 3 activities you most frequently do, circle each corresponding number with “○”, and fill in the blanks in descending order of time spent as follows:

, , .

1 看電視 Watching TV	8 園藝、照顧寵物 Garden work, pet caring	15 手工(編制、刺繡、陶藝) Doing handwork (knitting, embroidery, pottery)
2 聽廣播、音樂 Listening to radio and music	9 遛狗 Walking my dog	16 到現場觀看體育比賽 Watching sports event on site
3 玩電腦/手機/遊戲機 Using computers/mobile/ game console	10 唱歌、唱戲 Karaoke	17 郊遊 Outing
4 讀書、看報 Reading books and newspaper	11 逛街、遊玩 Hanging out	18 補充睡眠 Napping
5 打牌、下棋 Playing chess or poker	12 做家務 Doing house chores	19 陪孩子玩 Accompanying my child
6 聊天、聚會 Chatting, social gathering	13 書法、繪畫、彈琴 Calligraphy, painting, playing music instrument	20 陪孩子做功課及復習 Assisting my child with homework
7 體育鍛煉 Exercising	14 看演出/電影 Watching shows/movies	21 其他 Others

- C11. 【單選題】您日常參加體育鍛煉的頻率如何? 請在您選中的選項對應的序號上畫“○”。

【Single choice question】What is your exercise frequency? Choose the proper answer and circle its corresponding number with “○”.

1 平均每週7次或以上 7 times or more on average per week	6 平均每週2次 Twice a week on average
2 平均每週6次 6 times on average per week	7 平均每週1次 Once a week on average
3 平均每週5次 5 times on average per week	8 平均每月1次或以上, 但每週不足1次 Once or more per month, but less than once a week on average
4 平均每週4次 4 times on average per week	9 平均每月不足1次 Fewer than once a month
5 平均每週3次 3 times on average per week	10 從不參加體育鍛煉(不用回答C12至C16題) Never (skip Questions C12~C16)

2020年澳門市民體質監測數據登錄冊

Data Registration Manual of
2020 Physical Fitness Study of Macao SAR Residents

C12. 【單選題】多數情況下，您每次能鍛煉多長時間？請在您選中的選項對應的序號上畫“○”。

【Single choice question】What is your exercise duration each time in most cases? Choose the proper answer and circle its corresponding number with “○”.

1	10分鐘以下 Less than 10 minutes	4	30至59分鐘 30-59 minutes
2	10~19分鐘 10-19 minutes	5	60至119分鐘 60-119 minutes
3	20~29分鐘 20-29 minutes	6	120分鐘或以上 120 minutes or more

C13. 【單選題】多數情況下，您每次進行體育鍛煉時的身體感受是甚麼樣的？請在您選中的選項對應的序號上畫“○”。

【Single choice question】In most cases, how do you feel physically during exercising? Choose the proper answer and circle its corresponding number with “○”.

1	呼吸、心跳變化不大 Unchanged breathing and heart rate	2	呼吸、心跳加快，微微出汗 Slightly increased breathing, heart rate and slight sweating	3	呼吸急促，心跳明顯加快，出汗較多 Significantly increased breathing, heart rate and increased sweating
---	---	---	--	---	--

C14. 【填空題】您每週參加體育鍛煉的具體情況如何？請認真讀題後，在“”處填寫您的實際情況，如果沒有以下情況或不能每週都做，可以填“0”。注：填寫時間通常為10的倍數。

【Blank-filling question】What are your actual conditions when you do physical exercises each week? Read the question carefully, and fill in the blanks “” according to your actual conditions. If it is not applicable, write “0”. Note: The number you fill in should be a multiple of 10.

1) 您平均每週有多少天從事每次持續時間10分鐘以上的呼吸心跳明顯加快、出汗較多的大強度體育鍛煉？天；平均一天次；平均每次分鐘。

How many days in a typical week do you do high-intensity physical exercises lasting for more than 10 minutes with significantly increased breathing, heart rate and more sweating?
 day(s) a week; time(s) a day; minutes each time.

2) 您平均每週有多少天從事每次持續時間10分鐘以上的呼吸心跳加快、微微出汗的中等強度體育鍛煉？天；平均一天次；平均每次分鐘。

How many days in a typical week do you do moderate-intensity physical exercises lasting for more than 10 minutes with slightly increased breathing, heart rate and slight sweating?
 day(s) a week; time(s) a day; minutes each time.

成年人(20~39歲)
Adults (aged 20~39)

C15. 【單選題】按上述C11~C14題選擇的頻率、時間及強度開展體育鍛煉，您堅持了多長時間？請在您選中的最接近的選項對應的序號上畫“○”。

【Single choice question】 How long have you keep on exercising as per the exercise frequency, duration and intensity chosen in Questions C11~C14? Choose the proper answer and circle its corresponding number with “○”.

1	沒有 N/A	3	1個月或以上，但不足3個月 1 month or more, but less than 3 months	5	半年或以上，但不足1年 Half a year or more, but less than 1 year
2	不足1個月 Less than 1 month	4	3個月或以上，但不足半年 3 months or more, but less than half a year	6	1年或以上 1 year or more

C16. 【單選題】您通常每週有幾天進行力量練習(包括俯臥撐、仰臥起坐、引體向上、深蹲等徒手練習或使用啞鈴、彈力帶等健身器械的練習)？請在您選中的選項對應的序號上畫“○”。

【Single choice question】 How many days a week do you usually do strength training (including bodyweight training such as push-ups, sit-ups, pull-ups, and squats, or equipment workout such as using dumbbells and elastic bands)? Choose the proper answer and circle its corresponding number with “○”.

1	1天 1 day	5	5天 5 days
2	2天 2 days	6	6天 6 days
3	3天 3 days	7	7天 7 days
4	4天 4 days	8	0天 0 day

問卷完畢。謝謝。

This is the end of the questionnaire.
Thank you for participating.

2020年澳門市民體質監測數據登錄冊

Data Registration Manual of
2020 Physical Fitness Study of Macao SAR Residents

三. 檢測指標 (由監測人員在監測現場填寫)

Testing indicators (to be filled in by examiner on site)

1. 身高 (cm) Height (cm)	<input type="text"/> <input type="text"/> <input type="text"/> . <input type="text"/>
2. 坐高 (cm) Sitting height (cm)	<input type="text"/> <input type="text"/> . <input type="text"/>
3. 體重 (kg) Weight (kg)	<input type="text"/> <input type="text"/> <input type="text"/> . <input type="text"/>
4. 胸圍 (cm) Chest circumference (cm)	<input type="text"/> <input type="text"/> <input type="text"/> . <input type="text"/>
5. 腰圍 (cm) Waist circumference (cm)	<input type="text"/> <input type="text"/> <input type="text"/> . <input type="text"/>
6. 臀圍 (cm) Hip circumference (cm)	<input type="text"/> <input type="text"/> <input type="text"/> . <input type="text"/>
7. 體脂率 (%) Body fat percentage (%)	<input type="text"/> <input type="text"/> . <input type="text"/>
8. 肩寬 (cm) Shoulder width (cm)	<input type="text"/> <input type="text"/> . <input type="text"/>
9. 骨盆寬 (cm) Pelvis width (cm)	<input type="text"/> <input type="text"/> . <input type="text"/>
10. 足長 (cm) Foot length (cm)	<input type="text"/> <input type="text"/> . <input type="text"/>
11. 安靜脈搏 (次/分) Resting pulse (bpm)	<input type="text"/> <input type="text"/> <input type="text"/>
12. 收縮壓 (mmHg) Systolic blood pressure (mmHg)	<input type="text"/> <input type="text"/> <input type="text"/>
13. 舒張壓 (mmHg) Diastolic blood pressure (mmHg)	<input type="text"/> <input type="text"/> <input type="text"/>
14. 肺活量 (ml) Vital capacity (ml)	<input type="text"/> <input type="text"/> <input type="text"/> <input type="text"/>
15. 握力 (kg) Grip strength (kg)	<input type="text"/> <input type="text"/> . <input type="text"/>

成年人(20~39歲)
Adults (aged 20~39)

16. 縱跳 (cm) Vertical jump (cm)		<input type="text"/> <input type="text"/> . <input type="text"/>
17. 俯臥撐 (次) (男) / 一分鐘仰臥起坐 (次) (女) Push-ups (times) (M) / One-minute sit-ups (times) (F)		<input type="text"/> <input type="text"/>
18. 背力 (kg) Back strength (kg)		<input type="text"/> <input type="text"/> <input type="text"/>
19. 閉眼單腳站立 (秒) One foot stands with eyes closed (OFSEC) (sec)		<input type="text"/> <input type="text"/> <input type="text"/>
20. 選擇反應時 (秒) Choice reaction time (sec)		<input type="text"/> . <input type="text"/> <input type="text"/>
21. 坐位體前屈 (cm) Sit and reach (cm)		<input type="text"/> <input type="text"/> <input type="text"/> . <input type="text"/>
22. 臺階試驗 Step test	運動時間 (秒) Time (sec)	<input type="text"/> <input type="text"/> <input type="text"/>
	1分鐘後心率 (次) Heart rate after 1 minute (times)	<input type="text"/> <input type="text"/> <input type="text"/>
	2分鐘後心率 (次) Heart rate after 2 minutes (times)	<input type="text"/> <input type="text"/> <input type="text"/>
	3分鐘後心率 (次) Heart rate after 3 minutes (times)	<input type="text"/> <input type="text"/> <input type="text"/>

選測
Optional

23. 功率車二級負荷試驗 Submaximal bicycle ergometer exercise test	梅脫值(MET) _____ MET
	心肺耐力測試值 _____ ml/kg/min VO ₂ max
	絕對值約為 _____ L/min Absolute value

檢驗員簽署：
Examiner Signature : _____

2. Adults (aged 40~59)





歡迎閣下參加2020年澳門市民體質監測！澳門市民體質監測是特區政府為推動大眾健身活動的開展而進行的調查研究。在此首先感謝閣下對監測的支持並認真、如實地填寫問卷，我們保證對閣下的個人資料保密，有關資料不會獨立出現或使用，它將是整體數據的組成部分。再次對閣下的真誠參與表示感謝！

如對調查內容和檢測項目有任何疑問，歡迎向體育局運動醫學中心垂詢！

電話：28810896，88934540

Thank you for participating in our 2020 Physical Fitness Study! This study is organized by the Macao SAR Government to promote Sports for All. We are grateful for your participation. Your honesty and sincerity in filling out the questionnaire are appreciated. We promise to keep your personal data confidential and we will not publish or use your data individually. It will only be used as part of the whole study for statistical purposes. Again, we would like to extend our most sincere gratitude for your participation!

For any enquiries regarding the questionnaire or testing items, please feel free to contact Sports Medicine Centre of Macao Sports Bureau!
Telephone: 28810896, 88934540

2020年澳門市民體質監測數據登錄冊

Data Registration Manual of
2020 Physical Fitness Study of Macao SAR Residents體育局轄下運動醫學中心預先聲明
Declaration
Sports Medicine Centre of Macao Sports Bureau

本聲明旨在向個人資料當事人或相關家長或監護人確保遵守第8/2005號法律“個人資料保護法”所規範的事宜。

This declaration is intended to assure data subjects or their parents or guardians that we will strictly comply with the relevant provisions of Act 8/2005 - Personal Data Protection Act.

1. 處理個人資料的負責人—體育局，地址設於澳門羅理基博士大馬路818號。代表—體育局局長。

Personal data controller: Macao Sports Bureau, at Av. Dr. Rodrigo Rodrigues, n.º 818, Macao.
Representative - President of Macao Sports Bureau.

2. 處理個人資料的目的—進行澳門市民體質監測，以便為制定日後關於體育及醫療護理的政策提供科學數據。收集的數據旨在更新僅為統計用途的數據庫。

Purposes of processing personal data: To conduct the physical fitness study for Macao residents, and provide scientific references for the development of relevant policies regarding sports and medical care. Data collected through the physical fitness study will only be used to update the database for statistical purposes.

3. 個人資料當事人類別—參與是次計劃的澳門居民（隨年齡抽樣）。

Categories of subjects with personal data: Macao residents participated in the study (random sampling by age).

4. 個人資料接收者—個人資料當事人（或相關家長或監護人），運動醫學中心及國家體育總局體育科學研究所。

Personal data recipients: Data subjects (or their parents or guardians), Sports Medicine Centre and China Institute of Sport Science.

5. 接收及處理個人資料的條件—個人資料當事人（或相關家長或監護人）享有第8/2005號法律賦予的所有權利如查閱權及更正所收集的個人資料。運動醫學中心承諾對不正確的數據進行更正，刪除或封鎖。

Conditions of receiving and processing personal data: Data subjects (or their parents or guardians) are entitled by Act 8/2005 - Personal Data Protection Act to the rights to access and rectify their own personal data collected. The Sports Medicine Centre hereby commits to take proper measures to rectify, delete or block any incorrect data.

成年人(40~59歲)
Adults (aged 40~59)

6.處理個人資料的安全和保密性—對處理及編輯個人資料絕對保密及採取適當措施以確保其安全。

Security and confidentiality of processing personal data: Appropriate measures are implemented to process and edit the personal data to ensure strict confidentiality, safety and security of the data.

本人已明白上述內容權益

I, the undersigned, am aware of the contents and my legal rights in the above declaration.

(個人資料當事人或家長或監護人簽名)
(Signature of subject providing personal
data/parents/guardian)

_____/_____/_____
(日) (月) (年)
(DD) (MM) (YY)

姓名：	_____
Name:	_____
性別：	_____
Gender:	_____
年齡：	_____ (周歲)
Age:	_____ (years)
工作單位：	_____
Work unit:	_____
聯繫電話：	_____
Phone:	_____

2020年澳門市民體質監測數據登錄冊

Data Registration Manual of
2020 Physical Fitness Study of Macao SAR Residents

一.分類編碼 General Information

填寫方法：

填寫選擇題時請將選擇答案的序號填入相應的方格中，如選答案（1），則在方格內填1；序號為兩位數時，兩位數字填入同一方格，如選項為（11），則將 填入同一方格，即填為 。在填寫多項選擇題時，如果僅選擇一個或兩個答案，則應在剩餘方格內填0。

Instructions for filling:

Please fill in the boxes with the corresponding numbers. For example, if the chosen answer is (1), fill in the box with "1". If the chosen option is a two digit number, write both digits in the same box. e.g. If the chosen option is (11), fill in the box with . For multiple choice questions, if only one or two option(s) were chosen, please fill in the remaining blank box(es) with "0".

1.澳門居民身份證號碼 Macao ID card number	<input type="text"/> <input type="text"/> <input type="text"/> <input type="text"/> <input type="text"/> <input type="text"/> <input type="text"/> <input type="text"/>		
2.性別 Gender	(1) 男 Male	(2) 女 Female	<input type="text"/>
3.出生日期 Date of birth	<input type="text"/> <input type="text"/> <input type="text"/> <input type="text"/> 年 Y	<input type="text"/> <input type="text"/> 月 M	<input type="text"/> <input type="text"/> 日 D
4.測試日期 Examination date	<input type="text"/> <input type="text"/> <input type="text"/> <input type="text"/> 年 Y	<input type="text"/> <input type="text"/> 月 M	<input type="text"/> <input type="text"/> 日 D
5.工作單位代碼（由監測人員填寫） Work unit code number (filled in by examiner)	<input type="text"/> <input type="text"/> <input type="text"/> <input type="text"/>		
6.測試序號（由監測人員填寫） Serial number (filled in by examiner)	<input type="text"/> <input type="text"/> <input type="text"/> <input type="text"/>		
7.居住在澳門的年限（年）（指連續在澳門居住的年限，如果離開澳門的時間超過1年，則要由回澳門居住起重新計算居澳年限） Years of residence in Macao (It refers to years of continuous residence in Macao. If you had left Macao for over 1 year, years of residence in Macao should be recalculated from the time of returning to Macao.)	<input type="text"/> <input type="text"/>		

成年人(40~59歲)
Adults (aged 40~59)

<p>8. 日常主要勞作方式 Labor intensity of daily work</p> <p>(1) 以靜坐伏案等靜態性活動為主 (如用電腦、書寫等) Mainly sedentary work (such as computer use, paperwork, etc.)</p> <p>(2) 日常勞作中以靜坐伴有上肢活動，或大部份時間多以站立或走動為主 (如計程車司機、售貨員、流水線組裝工等) Mainly work done seated with upper limb movements, or standing or walking during most of the work time (such as taxi drivers, sales personnel, assembly line workers, etc.)</p> <p>(3) 日常勞作中主要從事重體力性活動、搬運或舉重物、挖掘等 (如建築工人等) Mainly heavy physical activities, manual load handling or lifting, digging, etc. (such as construction workers, etc.)</p>	<input type="checkbox"/>
<p>9. 出生地 Place of birth</p> <p>(1) 中國大陸 Mainland China (2) 澳門 Macao (3) 香港 Hong Kong (4) 葡萄牙 Portugal (5) 其他 Others</p>	<input type="checkbox"/>
<p>10. 居住地所屬堂區 Parish of residence</p> <p>(1) 聖方濟各堂區 (路環) Paróquia de São Francisco Xavier (Coloane)</p> <p>(2) 聖嘉模堂區 (氹仔) Paróquia de Nossa Senhora do Carmo (Taipa)</p> <p>(3) 風順堂區 (包括媽閣山、西望洋山、下環及內港一帶) Paróquia de S. Lourenço (Zonas das Colinas da Barra e da Penha, da Praia do Manduco e do Porto Interior)</p> <p>(4) 大堂區 (新馬路一帶、南灣、水坑尾、新口岸南北地段及南灣湖發展區) Paróquia da Sé Catedral (Zonas da Almeida Ribeiro, da Praia Grande, da Rua do Campo, dos Lotes norte e sul do Porto Exterior e da Zona do Lago Nam Van)</p> <p>(5) 花王堂區 (聖安多尼堂區，在澳門西部，包括高士德大馬路、新橋和沙梨頭) Paróquia de Santo António (Zonas da Freguesia de Santo António, do Oeste de Macau, incluindo Av. Horta e Costa, de San Kiu e do Patane)</p> <p>(6) 望德堂區 (包括荷蘭園、松山一帶) Paróquia de S. Lázaro (Zona do Conselheiro Ferreira de Almeida e da Colina da Guia)</p> <p>(7) 花地瑪堂區 (俗稱北區，包括青洲、台山、黑沙環、筷子基和水塘) Paróquia de Nossa Senhora de Fátima (Zonas do Norte, incluindo Ilha Verde, Tamagnini Barbosa, Areia Preta, Fái Chi Kei e Reservatório)</p>	<input type="checkbox"/>
<p>11. 學歷 Education level</p> <p>(1) 小學程度以下 Below primary school education (2) 小學 Primary school (3) 中學 Secondary school</p> <p>(4) 專上教育 Post-secondary education (5) 碩士 Master (6) 博士 Doctoral</p>	<input type="checkbox"/>

2020年澳門市民體質監測數據登錄冊

Data Registration Manual of
2020 Physical Fitness Study of Macao SAR Residents12. 目前主要從事的職業
Current occupation

- (1) 立法機關成員、公共行政高級官員、社團領導人員及經理
Legislative officer, public administration officer, community leader or manager
- (2) 專業人員（各學科領域之專業工作者，也包括高等教育及中學教學人員）
Professional (professionals in various disciplines including higher education and secondary school teaching staff)
- (3) 技術員及輔助專業人員（各學科領域中主要從事技術操作工作，也包括幼教、小學及特殊教育教師）
Technician or professional assistant (persons who engaged in technical works in various disciplines including preschool, primary school and special education teachers)
- (4) 文員（包括秘書、文書工作文員、出納員、接待員、票務員及同類工作人員）
Office clerk (secretaries, secretarial work office clerks, cashiers, receptionists, ticket agents and workers of similar nature)
- (5) 服務、銷售及同類工作人員（如從事旅遊、餐飲、美容、保險等服務之工作人員、也包括消防員、交通及治安警察人員、保安員、售貨人員等）
Customer service, sales representative or similar nature (persons who engaged in tourism, catering, beauty care, insurance, and also including firefighters, traffic and public security police officers, security staff, sales personnel etc.)
- (6) 漁農業熟練工作者（如漁民、農夫、儲藏及銷售漁農業及畜牧業產品等人員）
Skilled worker in the fishery or agricultural field (fisher folks, farmers, and persons who engaged in storing and selling of fishery, agricultural, and livestock products etc.)
- (7) 工業工匠及手工藝工人（包括建築工人及手工業製作工人）
Artisan or craftsperson (including construction workers and handicraft workers)
- (8) 機台、機器操作員、司機及裝配員
Machine operator, driver or assembler
- (9) 非技術工人（如清潔員、管理員、信差、搬運工人）
Non-technician (e.g. cleaners, property management officers, postpersons, porters)
- (10) 其他
Others
- (11) 待業
Unemployed
- (12) 家庭主婦/夫
housewife/househusband

13. 近5年曾患過何種疾病（經醫院確診的疾病）（選擇“無”者請直接回答問題第15題），
Any hospital-diagnosed diseases suffered within the past 5 years?
(If the answer is “no”, skip to Question 15)

- (1) 有 (2) 無
Yes No

成年人(40~59歲)
Adults (aged 40~59)

<p>14. 患病種類 (患病者按主次順序, 最多可填寫3項) Diseases suffered (in order of precedence, choose up to 3 diseases)</p> <table border="0"> <tr> <td>(1) 急性支氣管炎 Acute bronchitis</td> <td>(2) 肺炎 Pneumonia</td> <td>(3) 腸炎、胃炎 Enteritis, gastritis</td> </tr> <tr> <td>(4) 胃潰瘍 Gastric ulcer</td> <td>(5) 咽喉炎 Pharyngitis</td> <td>(6) 鼻炎 Rhinitis</td> </tr> <tr> <td>(7) 中耳炎 Otitis media</td> <td>(8) 結膜炎、乾眼症 Conjunctivitis, dry eye syndrome</td> <td>(9) 牙周炎 Periodontitis</td> </tr> <tr> <td>(10) 膽結石、慢性膽囊炎 Gallstone, chronic cholecystitis</td> <td>(11) 過敏性皮炎 Allergic dermatitis</td> <td>(12) 腳癬 Tinea pedis</td> </tr> <tr> <td>(13) 尿道炎 Urethritis</td> <td>(14) 陰道炎、宮頸炎 Coleitis, cervicitis</td> <td>(15) 風疹、麻疹、水痘 Rubella, measles, varicella</td> </tr> <tr> <td>(16) 貧血 Anemia</td> <td>(17) 糖尿病 Diabetes</td> <td>(18) 高血脂 Hyperlipemia</td> </tr> <tr> <td>(19) 高血壓 Hypertension</td> <td>(20) 心臟病 Heart disease</td> <td>(21) 腦卒中 Cerebral stroke</td> </tr> <tr> <td>(22) 腫瘤 Tumor</td> <td>(23) 類風濕性關節炎 Rheumatoid arthritis</td> <td>(24) 椎間盤疾病 Discopathy</td> </tr> <tr> <td>(25) 腎炎 Nephritis</td> <td>(26) 肝炎 Hepatitis</td> <td>(27) 長期失眠 Long-term insomnia</td> </tr> <tr> <td>(28) 意外傷害(造成人體的損傷而需要醫治或影響了正常的活動) Accidental injury (injury to the body that needs treatments, or injury that affects normal activities)</td> <td>(29) 其他 Others</td> <td></td> </tr> </table>	(1) 急性支氣管炎 Acute bronchitis	(2) 肺炎 Pneumonia	(3) 腸炎、胃炎 Enteritis, gastritis	(4) 胃潰瘍 Gastric ulcer	(5) 咽喉炎 Pharyngitis	(6) 鼻炎 Rhinitis	(7) 中耳炎 Otitis media	(8) 結膜炎、乾眼症 Conjunctivitis, dry eye syndrome	(9) 牙周炎 Periodontitis	(10) 膽結石、慢性膽囊炎 Gallstone, chronic cholecystitis	(11) 過敏性皮炎 Allergic dermatitis	(12) 腳癬 Tinea pedis	(13) 尿道炎 Urethritis	(14) 陰道炎、宮頸炎 Coleitis, cervicitis	(15) 風疹、麻疹、水痘 Rubella, measles, varicella	(16) 貧血 Anemia	(17) 糖尿病 Diabetes	(18) 高血脂 Hyperlipemia	(19) 高血壓 Hypertension	(20) 心臟病 Heart disease	(21) 腦卒中 Cerebral stroke	(22) 腫瘤 Tumor	(23) 類風濕性關節炎 Rheumatoid arthritis	(24) 椎間盤疾病 Discopathy	(25) 腎炎 Nephritis	(26) 肝炎 Hepatitis	(27) 長期失眠 Long-term insomnia	(28) 意外傷害(造成人體的損傷而需要醫治或影響了正常的活動) Accidental injury (injury to the body that needs treatments, or injury that affects normal activities)	(29) 其他 Others		<input type="text"/> <input type="text"/> <input type="text"/>
(1) 急性支氣管炎 Acute bronchitis	(2) 肺炎 Pneumonia	(3) 腸炎、胃炎 Enteritis, gastritis																													
(4) 胃潰瘍 Gastric ulcer	(5) 咽喉炎 Pharyngitis	(6) 鼻炎 Rhinitis																													
(7) 中耳炎 Otitis media	(8) 結膜炎、乾眼症 Conjunctivitis, dry eye syndrome	(9) 牙周炎 Periodontitis																													
(10) 膽結石、慢性膽囊炎 Gallstone, chronic cholecystitis	(11) 過敏性皮炎 Allergic dermatitis	(12) 腳癬 Tinea pedis																													
(13) 尿道炎 Urethritis	(14) 陰道炎、宮頸炎 Coleitis, cervicitis	(15) 風疹、麻疹、水痘 Rubella, measles, varicella																													
(16) 貧血 Anemia	(17) 糖尿病 Diabetes	(18) 高血脂 Hyperlipemia																													
(19) 高血壓 Hypertension	(20) 心臟病 Heart disease	(21) 腦卒中 Cerebral stroke																													
(22) 腫瘤 Tumor	(23) 類風濕性關節炎 Rheumatoid arthritis	(24) 椎間盤疾病 Discopathy																													
(25) 腎炎 Nephritis	(26) 肝炎 Hepatitis	(27) 長期失眠 Long-term insomnia																													
(28) 意外傷害(造成人體的損傷而需要醫治或影響了正常的活動) Accidental injury (injury to the body that needs treatments, or injury that affects normal activities)	(29) 其他 Others																														
<p>15. 在此之前, 是否聽說過“體質測定” Have you ever heard of the “Physical Fitness Study”?</p> <p>(1) 是 (2) 否 Yes No</p>	<input type="checkbox"/>																														
<p>16. 在此之前, 是否參加過“體質測定” Have you ever participated in the “Physical Fitness Study”?</p> <p>(1) 是 (2) 否 Yes No</p>	<input type="checkbox"/>																														
<p>17. 對“體質測定”的認識 (按照主次順序, 最多選3項) What is your understanding of the “Physical Fitness Study”? (in order of precedence, at most 3 options)</p> <p>(1) 無意義 Meaningless</p> <p>(2) 瞭解自己的體質狀況 To understand the physical fitness status of oneself</p> <p>(3) 認識體育鍛煉的重要性 To recognize the importance of physical exercising</p> <p>(4) 增長科學健身知識 To improve knowledge of scientific fitness</p>	<input type="text"/> <input type="text"/> <input type="text"/>																														

2020年澳門市民體質監測數據登錄冊

Data Registration Manual of
2020 Physical Fitness Study of Macao SAR Residents

二. 健身素養問卷 Fitness Literacy

A-知識、認知和態度 Knowledge, cognition and attitude

A1. 【單選題】您認為以下說法是否正確，正確選1、不正確選2、不知道選3，並在您選的數字上畫“○”。

[Single choice question] Which of the following descriptions do you think are correct? Choose 1 for “Correct”, 2 for “Incorrect”, 3 for “Don’t know”, and circle each corresponding number with “○”.

題目 Question	正確 Correct	不正確 Incorrect	不知道 Don't know
1) 清晨是鍛煉的最佳時間 Morning is the best time for physical exercise.	1	2	3
2) 大強度運動有利於減肥 High-intensity exercise is good for losing weight.	1	2	3
3) 吃飯後需要休息約30分鐘再去散步 A 30 minute rest is needed after eating before going for a walk.	1	2	3
4) 跑步應該選擇堅硬平坦的地面 Choose hard and flat ground when running.	1	2	3
5) 跳繩可以預防骨質疏鬆 Rope skipping can prevent osteoporosis.	1	2	3
6) 體育鍛煉時最好穿純棉服裝 It is best to wear pure cotton clothing when exercising.	1	2	3
7) 游泳後不能立刻吃東西 Don't eat right after swimming.	1	2	3
8) 運動處方是指針對某一類人群的身體狀況，採用處方的形式規定健身者鍛煉的內容和運動量的方法 Exercise prescription is used to specify the content and amount of exercise in the form of prescription, according to the physical condition of a targeted group.	1	2	3
9) 腹式呼吸是指開始吸氣時全身用力，此時胸部及腹部會充滿空氣而鼓起，然後用力將氣吐出 Abdominal breathing refers to the breathing method of inhaling deeply to fill the chest and bulging belly with air, and then exhaling deeply.	1	2	3
10) 有氧運動是人體在氧氣充分供應的情況下進行運動強度低、運動時間較長且富韻律性的體育鍛煉，如游泳、慢跑 Aerobic exercise is a kind of rhythmic exercise that is low intensity and long duration under the condition of sufficient oxygen supply, such as swimming and jogging.	1	2	3

成年人(40~59歲)
Adults (aged 40~59)

A2. 【單選題】以下說法您是否同意，非常不贊同選1、不太贊同選2、一般選3、比較贊同選4、非常贊同選5，並在您選的數字上畫“○”。

【Single choice question】 Which of the following descriptions do you agree with? Choose 1 for “Strongly disagree”, 2 for “Slightly disagree”, 3 for “Neutral”, 4 for “Relatively agree”, 5 for “Strongly agree”, and circle each corresponding number with “○”.

題目 Question	非常不贊同 Strongly disagree	不太贊同 Slightly disagree	一般 Neutral	比較贊同 Relatively agree	非常贊同 Strongly agree
1) 總體來評價，健身活動是一項積極向上的活動 Generally speaking, fitness activity is an activity that is positive.	1	2	3	4	5
2) 健身活動有益於保持身體健康 Fitness activity is good for body health.	1	2	3	4	5
3) 健身活動可以舒緩焦慮、煩躁的情緒 Fitness activity can relieve anxiety or irritability.	1	2	3	4	5
4) 健身活動可以增強人的意志 Fitness activity can hone the will.	1	2	3	4	5
5) 健身活動是無趣的 Fitness activity is boring.	1	2	3	4	5
6) 健身活動是非常值得去做的活動 Fitness activity is well worth doing.	1	2	3	4	5
7) 健身是我生活中可以缺少的一部分 Exercising is a part of my life that I can live without.	1	2	3	4	5
8) 不管多忙，都應該抽時間去健身 We should spare time for exercising no matter how busy we are.	1	2	3	4	5
9) 把錢花在健身方面是值得的 Spending money on exercising is worthwhile.	1	2	3	4	5
10) 我願意說服周圍的人同我一起健身 I would like to persuade others to work out with me.	1	2	3	4	5

2020年澳門市民體質監測數據登錄冊

Data Registration Manual of
2020 Physical Fitness Study of Macao SAR Residents

A3. 【單選題】下面的說法是否符合您的實際情況？非常不符合選1、不太符合選2、一般選3、比較符合選4、非常符合選5，並在您選的數字上畫“○”。

[Single choice question] Which of the following descriptions is accurate according to your situation? Choose 1 for “Very inconsistent”, 2 for “Not quite consistent”, 3 for “Neutral”, 4 for “Slightly consistent”, 5 for “Very consistent”, and circle each corresponding number with “○”.

題目 Question	非常不符合 Very inconsistent	不太符合 Not quite consistent	一般 Neutral	比較符合 Slightly consistent	非常符合 Very consistent
1) 我已經掌握的體育鍛煉技能是正確的、科學的 I think the exercising skills that I have acquired are correct and scientific.	1	2	3	4	5
2) 已經或正準備去瞭解、諮詢一下體育健身的專業人士（如體育老師、健身教練、電視節目），聽一下他們的專業意見 I have visited or am planning to consult with sports and fitness professionals (e.g., PE teachers, fitness coaches, TV shows) and get their professional advice.	1	2	3	4	5

成年人(40~59歲)
Adults (aged 40~59)

B-健身技能 Fitness skills

B1. 【多選排序題】體育鍛煉的主要項目有哪些？本題為多選題，可選1個或1個以上的答案，請圈選所有您主要參加的體育鍛煉項目，在選項對應的序號上畫“○”，並按照經常參加的頻率由高到低排序後將對應序號填寫如下：、、、、、、、、、。如果沒有參加過任何運動項目只圈選33即可。

【Multiple-choice sorting question】 What are the physical exercises in which you frequently participated? This is a multiple choice question, you need to choose at least 1 or more option(s). Choose the physical exercises you have frequently participated, circle the corresponding number with “○”, and fill in the blanks in descending order of frequency as follows: , , , , , , , , , . If your answer is “None”, circle the number 33.

1	步行 (健步走) Walking (Brisk walking)	12	門球、地擲球 Gate ball, bocce ball	23	騎自行車 Cycling
2	跑步 Running	13	高爾夫球 Golf	24	瑜伽、普拉提 Yoga, Pilates
3	跳高 High jump	14	柔力球 Softball	25	力量、健美 (徒手、器械) Strength exercises, body building (bodyweight training, equipment workout)
4	跳遠 Long jump	15	健身操類 (體操、健美操等) Aerobics (such as gymnastics, aerobics, etc.)	26	滑冰 Skating
5	登山、攀岩 Hiking, rock climbing	16	舞蹈類 (廣場舞、民族舞等) Dancing (such as square dance, folk dance, etc.)	27	滑雪 Skiing
6	籃球 Basketball	17	武術 (武術套路、太極、木蘭等) Martial arts (such as series of skills, taiji, mulan, etc.)	28	游泳 Swimming
7	排球 Volleyball	18	健身氣功 (易筋經、八段錦、五禽戲、 六字訣等) Qigong (such as yijinjing, baduanjin, wuqinxi, liuzijue, etc.)	29	跳繩 Rope skipping
8	足球 Football	19	拳擊、摔跤、散打 Boxing, wrestling, free combat	30	踢毽 Shuttlecock kicking
9	網球 Tennis	20	跆拳道 Taekwondo	31	輪滑 Roller skating
10	乒乓球 Table tennis	21	空手道 Karate	32	其他 Other
11	羽毛球 Badminton	22	柔道 Judo	33	沒有參加過任何運動項目 (不用回答B2、C1題) None (skip Questions B2, C1)

2020年澳門市民體質監測數據登錄冊

Data Registration Manual of
2020 Physical Fitness Study of Macao SAR Residents

B2. 【多選排序題】您能夠熟練掌握的體育鍛煉項目有哪些（熟練是指自己能掌握某項運動的基本技能和基本比賽規則）？本題為多選題，可選1個或1個以上的答案，請圈選所有您熟練掌握的運動項目，在選項對應的序號上畫“○”，並按照熟練程度排序後將對應序號填寫如下：

、、、、、、、、。如果沒有熟練掌握的項目只圈選33即可。

【Multiple-choice sorting question】What kinds of physical exercises are you proficient at (Proficiency means that you have acquired the basic skills and basic competition rules of the exercise)? This is a multiple choice question, you need to choose at least 1 or more option(s). Choose all the physical exercises in which you are proficient at, circle the corresponding number with “○”, and fill in the blanks in descending order of proficiency as follows: , , , , , , , , . If your answer is “None”, circle the number 33.

1	步行（健步走） Walking (Brisk walking)	12	門球、地擲球 Gate ball, bocce ball	23	騎自行車 Cycling
2	跑步 Running	13	高爾夫球 Golf	24	瑜伽、普拉提 Yoga, Pilates
3	跳高 High jump	14	柔力球 Softball	25	力量、健美（徒手、器械） Strength exercises, body building (bodyweight training, equipment workout)
4	跳遠 Long jump	15	健身操類（體操、健美操等） Aerobics (such as gymnastics, aerobics, etc.)	26	滑冰 Skating
5	登山、攀岩 Hiking, rock climbing	16	舞蹈類（廣場舞、民族舞等） Dancing (such as square dance, folk dance, etc.)	27	滑雪 Skiing
6	籃球 Basketball	17	武術（武術套路、太極、木蘭等） Martial arts (such as series of skills, taiji, mulan, etc.)	28	游泳 Swimming
7	排球 Volleyball	18	健身氣功（易筋經、八段錦、五禽戲、 六字訣等） Qigong (such as yijinjing, baduanjin, wuqinxi, liuzijue, etc.)	29	跳繩 Rope skipping
8	足球 Football	19	拳擊、摔跤、散打 Boxing, wrestling, free combat	30	踢毽 Shuttlecock kicking
9	網球 Tennis	20	跆拳道 Taekwondo	31	輪滑 Roller skating
10	乒乓球 Table tennis	21	空手道 Karate	32	其他 Other
11	羽毛球 Badminton	22	柔道 Judo	33	沒有熟練掌握的項目 None

成年人(40~59歲)
Adults (aged 40~59)

B3. 【多選題】 您知道運動前要做的準備活動有哪些？本題為多選題，可選1個或1個以上的答案，請圈選所有您知道的準備活動，在選項對應的序號上畫“○”。如果沒有知道的準備活動只圈選10即可。

【Multiple choice question】 What kinds of warm-up exercises should be done before exercising? This is a multiple choice question, you need to choose at least 1 or more option(s). Choose all the warm-up exercises you know, and circle each corresponding number with “○”. If your answer is “None”, circle the number 10.

1	慢跑 Jogging	6	壓腿（包括前壓腿和側壓腿） Leg stretch (including forward lunge stretch and side lunge stretch)
2	腰部運動（如扭腰） Waist movement (such as waist twisting)	7	體前屈 Forward bend
3	肩部運動（轉動肩膀） Shoulder movement (rolling shoulders)	8	原地高抬腿 High-knee running in place
4	關節活動（包括手腕關節、頸關節和腳踝關節） Joint movement (including wrist, neck and ankle joints)	9	其他 Others
5	擴胸運動 Chest expansion exercise	10	沒有知道的準備活動（不用回答B4題） None (skip Question B4)

B4. 【多選題】 您能夠熟練掌握的準備活動有哪些（熟練是指自己獨立會做某項準備活動）？本題為多選題，可選1個或1個以上的答案，請圈選所有您熟練掌握的準備活動，在選項對應的序號上畫“○”。如果沒有熟練掌握的準備活動只圈選10即可。

【Multiple choice question】 What kinds of warm-up exercises are you proficient at (Proficiency means that you would conduct the warm-up exercise when on your own)? This is a multiple choice question, you need to choose at least 1 or more option(s). Choose all the warm-up exercises in which you are proficient at, and circle each corresponding number with “○”. If your answer is “None”, circle the number 10.

1	慢跑 Jogging	6	壓腿（包括前壓腿和側壓腿） Leg stretch (including forward lunge stretch and side lunge stretch)
2	腰部運動（如扭腰） Waist movement (such as waist twisting)	7	體前屈 Forward bend
3	肩部運動（轉動肩膀） Shoulder movement (rolling shoulders)	8	原地高抬腿 High-knee running in place
4	關節活動（包括手腕關節、頸關節和腳踝關節） Joint movement (including wrist, neck and ankle joints)	9	其他 Others
5	擴胸運動 Chest expansion exercise	10	沒有熟練掌握的準備活動 None

2020年澳門市民體質監測數據登錄冊

Data Registration Manual of
2020 Physical Fitness Study of Macao SAR Residents

B5. 【單選題】下面的說法是否符合您的實際情況？非常不符合選1、不太符合選2、一般選3、比較符合選4、非常符合選5，並在您選的數字上畫“○”。

【Single choice question】 Which of the following descriptions is accurate according to your situation? Choose 1 for “Very inconsistent”, 2 for “Not quite consistent”, 3 for “Neutral”, 4 for “Slightly consistent”, 5 for “Very consistent”, and circle each corresponding number with “○”.

題目 Question	非常不符合 Very inconsistent	不太符合 Not quite consistent	一般 Neutral	比較符合 Slightly consistent	非常符合 Very consistent
1) 能夠結合自己的情況選擇適合自己的體育鍛煉項目 I can choose physical exercises that suit me.	1	2	3	4	5
2) 能夠根據自身狀況合理的制定健身計劃 I can reasonably develop a fitness plan based on my actual condition.	1	2	3	4	5
3) 能夠根據實際情況及時對健身計劃作出調整 I can promptly adjust my fitness plan based on my actual condition.	1	2	3	4	5

B6. 【單選題】下面的說法是否符合您的實際情況？非常不符合選1、不太符合選2、一般選3、比較符合選4、非常符合選5，並在您選的數字上畫“○”。

【Single choice question】 Which of the following descriptions is accurate according to your situation? Choose 1 for “Very inconsistent”, 2 for “Not quite consistent”, 3 for “Neutral”, 4 for “Slightly consistent”, 5 for “Very consistent”, and circle each corresponding number with “○”.

題目 Question	非常不符合 Very inconsistent	不太符合 Not quite consistent	一般 Neutral	比較符合 Slightly consistent	非常符合 Very consistent
1) 對於喜歡的健身項目，您認為已經很好地掌握了該健身項目所要求的技能 I think I have adequately acquired the skills of exercises that I like.	1	2	3	4	5
2) 只要自己願意，您可以堅持進行健身活動 I can persist in exercising if I want to.	1	2	3	4	5

成年人(40~59歲)
Adults (aged 40~59)

C-習慣養成 Habit formation

C1. 【單選題】您是如何選中B1題中的這些體育鍛煉項目的？請在您選中的選項對應的序號上畫“○”。

【Single choice question】 How did you choose the physical exercises in Question B1? Choose the proper answer and circle its corresponding number with “○”.

1	自己隨便選的 I chose them randomly	4	跟著家人、朋友或同事等選的 I followed the choices of my family members, friends or colleagues.
2	哪些項目練起來方便就選哪些 I chose them because they are convenient to do.	5	哪些項目容易就選哪些 I chose them because they are easy to do.
3	跟著潮流走的 Follow the general trend.	6	諮詢過專業意見 I chose them after seeking for professional advice.

C2. 【限選排序題】阻礙您開展體育鍛煉的原因是甚麼？本題為限選排序題，請圈選出3個對您來說最主要的原因，在選項對應的序號上畫“○”，並依據重要程度由高到低進行排序後將序號依次填寫在以下方框上：、、。

【Three-choice sorting question】 What are the main obstacles to your participation in physical exercise? This is a three-choice sorting question, choose the top 3 reasons, circle each corresponding number with “○”, and fill in the blanks in order of precedence as follows: , , .

1	工作忙 Busy work	7	沒有健身場地 Lack of suitable venues
2	家務忙 Too many house chores	8	健身場地距離太遠 Lack of fitness venues nearby
3	怕受傷 To avoid physical injury	9	周邊缺少體育健身組織 Lack of fitness clubs nearby
4	經濟條件不允許 Financial restraint	10	群眾性的健身賽事或者活動太少 Lack of events or activities for residents
5	對體育鍛煉沒有興趣 Lack of interest	11	社區組織開展的活動項目少，缺乏吸引力 Lack of such activities in community, or activities less attractive
6	不知道該怎麼鍛煉，缺乏指導 Lack of coaching advice	12	其他 Others

2020年澳門市民體質監測數據登錄冊

Data Registration Manual of
2020 Physical Fitness Study of Macao SAR Residents

C3.【單選題】您現在的工作狀態（是指您的職業活動，含義工或志願者工作但不包含家庭主婦/夫所從事的家務工作）如何？請在您選中的選項對應的序號上畫“○”，如果選擇1則同時填寫下劃線的內容。

【Single choice question】What is your current work status (i.e. your profession's activities, including volunteer work, but not including house chores conducted as housewives/husbands)? Choose the proper answer and circle its corresponding number with “○”, If you choose Option 1, fill in the blanks with answers.

1	每週工作 I work	<input type="text"/>	天，平均每天工作 hours per day,	<input type="text"/>	小時 days per week.
2	有工作但不定時 No regular work				
3	不工作（不用回答C4題） Unemployed (skip Question C4)				

C4.【填空題】您工作中的體力活動狀況如何？請認真讀題後，在“ ”處填寫您的實際情況，如果沒有以下情況的請填“0”。注：填寫時間通常為10的倍數。

【Blank-filling question】What is the labor intensity of your daily work? Read the question carefully, and fill in the blanks “ ” according to your actual conditions. If it is not applicable, write “0”. Note: The number you fill in should be a multiple of 10.

1) 您的工作中通常每週有多少天會做“呼吸和心跳顯著增加（如搬運或舉重物、挖掘或建築工作等）”持續時間10分鐘以上的劇烈活動？ 天；您通常一天工作中累計做多長時間的這種持續10分鐘以上的劇烈活動？ 分鐘。

How many days in a typical week at work do you do vigorous activities (e.g. manual load handling or lifting, digging or construction work) lasting for more than 10 minutes with “significantly increased breathing and heart rate”? days; What is the average cumulative time you spent on doing such vigorous activities lasting for more than 10 minutes at work in a typical day? minutes.

2) 您的工作中通常每週有多少天會做“呼吸和心跳輕度增加（如快步走、搬運較輕的物品）”持續時間10分鐘以上的中等強度活動？ 天；您通常一天工作中累計做多長時間的這種持續10分鐘以上的中等強度活動？ 分鐘。

How many days in a typical week at work do you do moderate-intensity activities (e.g. brisk walking, manual handling of light objects) lasting for more than 10 minutes with “slightly increased breathing and heart rate”? days; What is the average cumulative time you spent doing such moderate-intensity activities lasting for more than 10 minutes at work in a typical day? minutes.

C5.【填空題】您通常每天有多少時間坐著或者靠著？注：填寫分鐘通常為10的倍數。

【Blank-filling question】What is your average sitting or reclining time per day? Note: The number you fill in should be a multiple of 10.

請填寫： 小時 分鐘。
Please fill in the blanks: hours minutes

成年人(40~59歲)
Adults (aged 40~59)

C6. 【填空题】您通常每天睡眠（包括午睡）多少時間？注：填寫分鐘通常為10的倍數。

【Blank-filling question】 What is your average sleep time (including naps) per day? Note: The number you fill in should be a multiple of 10.

請填寫： 小時 分鐘。
Please fill in the blanks: hours minutes

C7. 【單選題】您通常最主要的交通出行方式是甚麼？請在您選中選項對應的序號上畫“○”。

【Single choice question】 What is your major means of transportation? Choose the proper answer and circle its corresponding number with “○”.

1	步行 On foot	4	駕車 Driving
2	騎自行車 Bicycling	5	乘公共交通、乘坐私家車或乘坐電單車等 By public transport, private car or motorcycle
3	騎電單車 Motorcycling	6	其他 Others

C8. 【填空题】您通常每週有多少天的出行交通方式為步行或騎自行車持續時間10分鐘以上（出行指的是去上班、購物、參加聚會等，但不包括專為體育鍛煉而進行的步行或者騎行。）？天；您通常一天在交通方面累計花多長時間這種持續10分鐘以上的步行或者騎自行車？分鐘。注：填寫時間通常為10的倍數；如果沒有這種情況的請填“0”。

【Blank-filling question】 How many days do you walk or bicycle for at least 10 minutes continuously in a typical week (It refers to the total time spent commuting to work, shopping and attending parties, etc., but do not include walking or bicycling specifically for exercising)? days; What is the average cumulative commuting time you spent walking or bicycling at least 10 minutes continuously in a typical day? minutes. Note: The number you fill in should be a multiple of 10; if it is not applicable, write “0”.

C9. 【填空题】您在做家務過程中的體力活動狀況如何？請認真讀題後，在“”處填寫您的實際情況，如果沒有以下情況的請填“0”。注：填寫時間通常為10的倍數。

【Blank-filling question】 What is the labor intensity of your daily house chores? Read the question carefully, and fill in the blanks “” according to your actual conditions. If it is not applicable, write “0”. Note: The number you fill in should be a multiple of 10.

1) 您生活中通常每週有多少天會從事持續時間10分鐘以上、大強度的家務勞動（比如搬提重物、庭院挖土等）？天；平均一天累計會做多長時間這種持續10分鐘以上的大強度家務勞動？分鐘。

How many days in a typical week do you do high-intensity house chores (e.g. manual load handling or lifting, digging in the yard, etc.) lasting for more than 10 minutes?

days; What is the average cumulative time you spent doing such high-intensity house chores lasting for more than 10 minutes in a typical day? minutes

2020年澳門市民體質監測數據登錄冊

Data Registration Manual of
2020 Physical Fitness Study of Macao SAR Residents

- 2) 您生活中通常每週有多少天會從事持續時間10分鐘以上、中等強度的家務勞動（比如搬提輕物、擦窗、擦地、打掃房間等）？天；平均一天累計會做多長時間這種持續10分鐘以上的中等強度家務勞動？分鐘。

How many days in a typical week do you do moderate-intensity house chores (e.g. handling or lifting light objects, wiping the window, mopping the floor, cleaning the room, etc.) lasting for more than 10 minutes? days; What is the average cumulative time you spent doing such moderate-intensity house chores lasting for more than 10 minutes in a typical day? minutes

- C10. 【限選排序題】請問您通常會從事哪些閒暇活動？本題為限選排序題，請圈選出3件最經常做的事，在選項對應的序號上畫“○”，並依據花費時間由長到短進行排序後將序號依次填寫在以下方框上：、、。

【Three-choice sorting question】What leisure-time activities do you usually do? This is a three-choice sorting question, choose the top 3 activities you most frequently do, circle each corresponding number with “○”，and fill in the blanks in descending order of time spent as follows:

, , .

1	看電視 Watching TV	8	園藝、照顧寵物 Garden work, pet caring	15	手工（編制、刺繡、陶藝） Doing handwork (knitting, embroidery, pottery)
2	聽廣播、音樂 Listening to radio and music	9	遛狗 Walking my dog	16	到現場觀看體育比賽 Watching sports event on site
3	玩電腦/手機/遊戲機 Using computers/mobile/ game console	10	唱歌、唱戲 Karaoke	17	郊遊 Outing
4	讀書、看報 Reading books and newspaper	11	逛街、遊玩 Hanging out	18	補充睡眠 Napping
5	打牌、下棋 Playing chess or poker	12	做家務 Doing house chores	19	陪孩子玩 Accompanying my child
6	聊天、聚會 Chatting, social gathering	13	書法、繪畫、彈琴 Calligraphy, painting, playing music instrument	20	陪孩子做功課及復習 Assisting my child with homework
7	體育鍛煉 Exercising	14	看演出/電影 Watching shows/movies	21	其他 Others

成年人(40~59歲)
Adults (aged 40~59)

C11. 【單選題】您日常參加體育鍛煉的頻率如何？請在您選中的選項對應的序號上畫“○”。

【Single choice question】What is your exercise frequency? Choose the proper answer and circle its corresponding number with “○”.

1	平均每週7次或以上 7 times or more on average per week	6	平均每週2次 Twice a week on average
2	平均每週6次 6 times on average per week	7	平均每週1次 Once a week on average
3	平均每週5次 5 times on average per week	8	平均每月1次或以上，但每週不足1次 Once or more per month, but less than once a week on average
4	平均每週4次 4 times on average per week	9	平均每月不足1次 Fewer than once a month
5	平均每週3次 3 times on average per week	10	從不參加體育鍛煉（不用回答C12至C16題） Never (skip Questions C12~C16)

C12. 【單選題】多數情況下，您每次能鍛煉多長時間？請在您選中的選項對應的序號上畫“○”。

【Single choice question】What is your exercise duration each time in most cases? Choose the proper answer and circle its corresponding number with “○”.

1	10分鐘以下 Less than 10 minutes	4	30至59分鐘 30-59 minutes
2	10~19分鐘 10-19 minutes	5	60至119分鐘 60-119 minutes
3	20~29分鐘 20-29 minutes	6	120分鐘或以上 120 minutes or more

C13. 【單選題】多數情況下，您每次進行體育鍛煉時的身體感受是甚麼樣的？請在您選中的選項對應的序號上畫“○”。

【Single choice question】In most cases, how do you feel physically during exercising? Choose the proper answer and circle its corresponding number with “○”.

1	呼吸、心跳變化不大 Unchanged breathing and heart rate	2	呼吸、心跳加快，微微出汗 Slightly increased breathing, heart rate and slight sweating	3	呼吸急促，心跳明顯加快，出汗較多 Significantly increased breathing, heart rate and increased sweating
---	---	---	--	---	--

2020年澳門市民體質監測數據登錄冊

Data Registration Manual of
2020 Physical Fitness Study of Macao SAR Residents

C14. 【**填空題**】 您每週參加體育鍛煉的具體情況如何？請認真讀題後，在“”處填寫您的實際情況，如果沒有以下情況或不能每週都做，可以填“0”。注：填寫時間通常為10的倍數。

【Blank-filling question】 What are your actual conditions when you do physical exercises each week? Read the question carefully, and fill in the blanks “” according to your actual conditions. If it is not applicable, write “0”. Note: The number you fill in should be a multiple of 10.

1) 您平均每週有多少天從事每次持續時間10分鐘以上的呼吸心跳明顯加快、出汗較多的大強度體育鍛煉？天；平均一天次；平均每次分鐘。

How many days in a typical week do you do high-intensity physical exercises lasting for more than 10 minutes with significantly increased breathing, heart rate and more sweating?

day(s) a week; time(s) a day; minutes each time.

2) 您平均每週有多少天從事每次持續時間10分鐘以上的呼吸心跳加快、微微出汗的中等強度體育鍛煉？天；平均一天次；平均每次分鐘。

How many days in a typical week do you do moderate-intensity physical exercises lasting for more than 10 minutes with slightly increased breathing, heart rate and slight sweating?

day(s) a week; time(s) a day; minutes each time.

C15. 【**單選題**】 按上述C11~C14題選擇的頻率、時間及強度開展體育鍛煉，您堅持了多長時間？請在您選中的最接近的選項對應的序號上畫“○”。

【Single choice question】 How long have you keep on exercising as per the exercise frequency, duration and intensity chosen in Questions C11~C14? Choose the proper answer and circle its corresponding number with “○”.

1	沒有 N/A	3	1個月或以上，但不足3個月 1 month or more, but less than 3 months	5	半年或以上，但不足1年 Half a year or more, but less than 1 year
2	不足1個月 Less than 1 month	4	3個月或以上，但不足半年 3 months or more, but less than half a year	6	1年或以上 1 year or more

成年人(40~59歲)
Adults (aged 40~59)

C16. 【單選題】您通常每週有幾天進行力量練習(包括俯臥撐、仰臥起坐、引體向上、深蹲等徒手練習或使用啞鈴、彈力帶等健身器械的練習)?請在您選中的選項對應的序號上畫“○”。

【Single choice question】 How many days a week do you usually do strength training (including bodyweight training such as push-ups, sit-ups, pull-ups, and squats, or equipment workout such as using dumbbells and elastic bands)? Choose the proper answer and circle its corresponding number with “○”.

1	1天 1 day	5	5天 5 days
2	2天 2 days	6	6天 6 days
3	3天 3 days	7	7天 7 days
4	4天 4 days	8	0天 0 day

問卷完畢。謝謝。

This is the end of the questionnaire.
Thank you for participating.

2020年澳門市民體質監測數據登錄冊

Data Registration Manual of
2020 Physical Fitness Study of Macao SAR Residents

三. 檢測指標 (由監測人員在監測現場填寫)

Testing indicators (to be filled in by examiner on site)

1. 身高 (cm) Height (cm)	<input type="text"/> <input type="text"/> <input type="text"/> . <input type="text"/>
2. 坐高 (cm) Sitting height (cm)	<input type="text"/> <input type="text"/> . <input type="text"/>
3. 體重 (kg) Weight (kg)	<input type="text"/> <input type="text"/> <input type="text"/> . <input type="text"/>
4. 胸圍 (cm) Chest circumference (cm)	<input type="text"/> <input type="text"/> <input type="text"/> . <input type="text"/>
5. 腰圍 (cm) Waist circumference (cm)	<input type="text"/> <input type="text"/> <input type="text"/> . <input type="text"/>
6. 臀圍 (cm) Hip circumference (cm)	<input type="text"/> <input type="text"/> <input type="text"/> . <input type="text"/>
7. 體脂率 (%) Body fat percentage (%)	<input type="text"/> <input type="text"/> . <input type="text"/>
8. 肩寬 (cm) Shoulder width (cm)	<input type="text"/> <input type="text"/> . <input type="text"/>
9. 骨盆寬 (cm) Pelvis width (cm)	<input type="text"/> <input type="text"/> . <input type="text"/>
10. 足長 (cm) Foot length (cm)	<input type="text"/> <input type="text"/> . <input type="text"/>
11. 安靜脈搏 (次/分) Resting pulse (bpm)	<input type="text"/> <input type="text"/> <input type="text"/>
12. 收縮壓 (mmHg) Systolic blood pressure (mmHg)	<input type="text"/> <input type="text"/> <input type="text"/>
13. 舒張壓 (mmHg) Diastolic blood pressure (mmHg)	<input type="text"/> <input type="text"/> <input type="text"/>

成年人(40~59歲)
Adults (aged 40~59)

14.肺活量 (ml) Vital capacity (ml)	<input type="text"/> <input type="text"/> <input type="text"/> <input type="text"/>	
15.握力 (kg) Grip strength (kg)	<input type="text"/> <input type="text"/> . <input type="text"/>	
16.閉眼單腳站立 (秒) One foot stands with eyes closed (OFSEC) (sec)	<input type="text"/> <input type="text"/> <input type="text"/>	
17.選擇反應時 (秒) Choice reaction time (sec)	<input type="text"/> . <input type="text"/> <input type="text"/>	
18.坐位體前屈 (cm) Sit and reach (cm)	<input type="text"/> <input type="text"/> <input type="text"/> . <input type="text"/>	
19.臺階試驗 Step test	運動時間 (秒) Time (sec)	<input type="text"/> <input type="text"/> <input type="text"/>
	1分鐘後心率 (次) Heart rate after 1 minute (times)	<input type="text"/> <input type="text"/> <input type="text"/>
	2分鐘後心率 (次) Heart rate after 2 minutes (times)	<input type="text"/> <input type="text"/> <input type="text"/>
	3分鐘後心率 (次) Heart rate after 3 minutes (times)	<input type="text"/> <input type="text"/> <input type="text"/>

選測
Optional

20.功率車二級負荷試驗 Submaximal bicycle ergometer exercise test	梅脫值(MET) _____ MET
	心肺耐力測試值 _____ ml/kg/min VO ₂ max
	絕對值約為 _____ L/min Absolute value

檢驗員簽署：
Examiner Signature : _____

IV. Seniors





歡迎閣下參加2020年澳門市民體質監測！澳門市民體質監測是特區政府為推動大眾健身活動的開展而進行的調查研究。在此首先感謝閣下對監測的支持並認真、如實地填寫問卷，我們保證對閣下的個人資料保密，有關資料不會獨立出現或使用，它將是整體數據的組成部分。再次對閣下的真誠參與表示感謝！

如對調查內容和檢測項目有任何疑問，歡迎向體育局運動醫學中心垂詢！

電話：28810896，88934540

Thank you for participating in our 2020 Physical Fitness Study! This study is organized by the Macao SAR Government to promote Sports for All. We are grateful for your participation. Your honesty and sincerity in filling out the questionnaire are appreciated. We promise to keep your personal data confidential and we will not publish or use your data individually. It will only be used as part of the whole study for statistical purposes. Again, we would like to extend our most sincere gratitude for your participation!

For any enquiries regarding the questionnaire or testing items, please feel free to contact Sports Medicine Centre of Macao Sports Bureau!
Telephone: 28810896, 88934540

2020年澳門市民體質監測數據登錄冊

Data Registration Manual of
2020 Physical Fitness Study of Macao SAR Residents體育局轄下運動醫學中心預先聲明
Declaration
Sports Medicine Centre of Macao Sports Bureau

本聲明旨在向個人資料當事人或相關家長或監護人確保遵守第8/2005號法律“個人資料保護法”所規範的事宜。

This declaration is intended to assure data subjects or their parents or guardians that we will strictly comply with the relevant provisions of Act 8/2005 - Personal Data Protection Act.

1. 處理個人資料的負責人—體育局，地址設於澳門羅理基博士大馬路818號。代表—體育局局長。

Personal data controller: Macao Sports Bureau, at Av. Dr. Rodrigo Rodrigues, n.º 818, Macao.
Representative - President of Macao Sports Bureau.

2. 處理個人資料的目的—進行澳門市民體質監測，以便為制定日後關於體育及醫療護理的政策提供科學數據。收集的數據旨在更新僅為統計用途的數據庫。

Purposes of processing personal data: To conduct the physical fitness study for Macao residents, and provide scientific references for the development of relevant policies regarding sports and medical care. Data collected through the physical fitness study will only be used to update the database for statistical purposes.

3. 個人資料當事人類別—參與是次計劃的澳門居民（隨年齡抽樣）。

Categories of subjects with personal data: Macao residents participated in the study (random sampling by age).

4. 個人資料接收者—個人資料當事人（或相關家長或監護人），運動醫學中心及國家體育總局體育科學研究所。

Personal data recipients: Data subjects (or their parents or guardians), Sports Medicine Centre and China Institute of Sport Science.

5. 接收及處理個人資料的條件—個人資料當事人（或相關家長或監護人）享有第8/2005號法律賦予的所有權利如查閱權及更正所收集的個人資料。運動醫學中心承諾對不正確的數據進行更正，刪除或封鎖。

Conditions of receiving and processing personal data: Data subjects (or their parents or guardians) are entitled by Act 8/2005 - Personal Data Protection Act to the rights to access and rectify their own personal data collected. The Sports Medicine Centre hereby commits to take proper measures to rectify, delete or block any incorrect data.

老年人(60~79歲)
Adults (aged 60~79)

6.處理個人資料的安全和保密性—對處理及編輯個人資料絕對保密及採取適當措施以確保其安全。

Security and confidentiality of processing personal data: Appropriate measures are implemented to process and edit the personal data to ensure strict confidentiality, safety and security of the data.

本人已明白上述內容權益

I, the undersigned, am aware of the contents and my legal rights in the above declaration.

(個人資料當事人或家長或監護人簽名)
(Signature of subject providing personal
data/parents/guardian)

_____/_____/_____
(日) (月) (年)
(DD) (MM) (YY)

姓名：	_____
Name:	_____
性別：	_____
Gender:	_____
年齡：	_____ (周歲)
Age:	_____ (years)
所屬單位：	_____
Senior agency:	_____
聯繫電話：	_____
Phone:	_____

2020年澳門市民體質監測數據登錄冊

Data Registration Manual of
2020 Physical Fitness Study of Macao SAR Residents

一.分類編碼 General Information

填寫方法：

填寫選擇題時請將選擇答案的序號填入相應的方格中，如選答案（1），則在方格內填1；序號為兩位數時，兩位數字填入同一方格，如選項為（11），則將 填入同一方格，即填為 。在填寫多項選擇題時，如果僅選擇一個或兩個答案，則應在剩餘方格內填0。

Instructions for filling:

Please fill in the boxes with the corresponding numbers. For example, if the chosen answer is (1), fill in the box with "1". If the chosen option is a two digit number, write both digits in the same box. e.g. If the chosen option is (11), fill in the box with . For multiple choice questions, if only one or two option(s) were chosen, please fill in the remaining blank box(es) with "0".

1.澳門居民身份證號碼 Macao ID card number	<input type="text"/> <input type="text"/> <input type="text"/> <input type="text"/> <input type="text"/> <input type="text"/> <input type="text"/> <input type="text"/>					
2.性別 Gender	(1) 男 Male	(2) 女 Female	<input type="text"/>			
3.出生日期 Date of birth	<input type="text"/> <input type="text"/> <input type="text"/> <input type="text"/>	年 Y	<input type="text"/> <input type="text"/>	月 M	<input type="text"/> <input type="text"/>	日 D
4.測試日期 Examination date	<input type="text"/> <input type="text"/> <input type="text"/> <input type="text"/>	年 Y	<input type="text"/> <input type="text"/>	月 M	<input type="text"/> <input type="text"/>	日 D
5.所屬單位代碼（由監測人員填寫） Senior agency code number (filled in by examiner)	<input type="text"/> <input type="text"/> <input type="text"/> <input type="text"/>					
6.測試序號（由監測人員填寫） Serial number (filled in by examiner)	<input type="text"/> <input type="text"/> <input type="text"/> <input type="text"/>					
7.居住在澳門的年限（年）（指連續在澳門居住的年限，如果離開澳門的時間超過1年，則要由回澳門居住起重新計算居澳年限） Years of residence in Macao (It refers to years of continuous residence in Macao. If you had left Macao for over 1 year, years of residence in Macao should be recalculated from the time of returning to Macao.)	<input type="text"/> <input type="text"/>					

老年人(60~79歲)
Adults (aged 60~79)

8. 日常主要勞作方式 Labor intensity of daily work	<input type="checkbox"/>
(1) 以靜坐伏案等靜態性活動為主 (如用電腦、書寫等) Mainly sedentary work (such as computer use, paperwork, etc.)	
(2) 日常勞作中以靜坐伴有上肢活動，或大部份時間多以站立或走動為主 (如計程車司機、售貨員、流水線組裝工等) Mainly work done seated with upper limb movements, or standing or walking during most of the work time (such as taxi drivers, sales personnel, assembly line workers, etc.)	
(3) 日常勞作中主要從事重體力性活動、搬運或舉重物、挖掘等 (如建築工人等) Mainly heavy physical activities, manual load handling or lifting, digging, etc. (such as construction workers, etc.)	
9. 出生地 Place of birth	<input type="checkbox"/>
(1) 中國大陸 Mainland China	(2) 澳門 Macao
(3) 香港 Hong Kong	(4) 葡萄牙 Portugal
(5) 其他 Others	
10. 居住地所屬堂區 Parish of residence	<input type="checkbox"/>
(1) 聖方濟各堂區 (路環) Paróquia de São Francisco Xavier (Coloane)	
(2) 聖嘉模堂區 (氹仔) Paróquia de Nossa Senhora do Carmo (Taipa)	
(3) 風順堂區 (包括媽閣山、西望洋山、下環及內港一帶) Paróquia de S. Lourenço (Zonas das Colinas da Barra e da Penha, da Praia do Manduco e do Porto Interior)	
(4) 大堂區 (新馬路一帶、南灣、水坑尾、新口岸南北地段及南灣湖發展區) Paróquia da Sé Catedral (Zonas da Almeida Ribeiro, da Praia Grande, da Rua do Campo, dos Lotes norte e sul do Porto Exterior e da Zona do Lago Nam Van)	
(5) 花王堂區 (聖安多尼堂區，在澳門西部，包括高士德大馬路、新橋和沙梨頭) Paróquia de Santo António (Zonas da Freguesia de Santo António, do Oeste de Macau, incluindo Av. Horta e Costa, de San Kiu e do Patane)	
(6) 望德堂區 (包括荷蘭園、松山一帶) Paróquia de S. Lázaro (Zona do Conselheiro Ferreira de Almeida e da Colina da Guia)	
(7) 花地瑪堂區 (俗稱北區，包括青洲、台山、黑沙環、筷子基和水塘) Paróquia de Nossa Senhora de Fátima (Zonas do Norte, incluindo Ilha Verde, Tamagnini Barbosa, Areia Preta, Fái Chi Kei e Reservatório)	
11. 學歷 Education level	<input type="checkbox"/>
(1) 小學程度以下 Below primary school education	(2) 小學 Primary school
(3) 中學 Secondary school	
(4) 專上教育 Post-secondary education	(5) 碩士 Master
(6) 博士 Doctoral	

2020年澳門市民體質監測數據登錄冊

Data Registration Manual of
2020 Physical Fitness Study of Macao SAR Residents

<p>12. 是否已退休 Retired?</p> <p>(1) 是 (2) 否 Yes No</p>	<input type="checkbox"/>
<p>13. 退休前（已退休者）/現在（未退休者）主要從事的職業 Occupation before retirement/current occupation</p> <p>(1) 立法機關成員、公共行政高級官員、社團領導人員及經理 Legislative officer, public administration officer, community leader or manager</p> <p>(2) 專業人員（各學科領域之專業工作者，也包括高等教育及中學教學人員） Professional (professionals in various disciplines including higher education and secondary school teaching staff)</p> <p>(3) 技術員及輔助專業人員（各學科領域中主要從事技術操作工作，也包括幼教、小學及特殊教育教師） Technician or professional assistant (persons who engaged in technical works in various disciplines including preschool, primary school and special education teachers)</p> <p>(4) 文員（包括秘書、文書工作文員、出納員、接待員、票務員及同類工作人員） Office clerk (secretaries, secretarial work office clerks, cashiers, receptionists, ticket agents and workers of similar nature)</p> <p>(5) 服務、銷售及同類工作人員（如從事旅遊、餐飲、美容、保險等服務之工作人員、也包括消防員、交通及治安警察人員、保安員、售貨人員等） Customer service, sales representative or similar nature (persons who engaged in tourism, catering, beauty care, insurance, and also including firefighters, traffic and public security police officers, security staff, sales personnel etc.)</p> <p>(6) 漁農業熟練工作者（如漁民、農夫、儲藏及銷售漁農業及畜牧業產品等人員） Skilled worker in the fishery or agricultural field (fisher folks, farmers, and persons who engaged in storing and selling of fishery, agricultural, and livestock products etc.)</p> <p>(7) 工業工匠及手工藝工人（包括建築工人及手工業製作工人） Artisan or craftsperson (including construction workers and handicraft workers)</p> <p>(8) 機台、機器操作員、司機及裝配員 Machine operator, driver or assembler</p> <p>(9) 非技術工人（如清潔員、管理員、信差、搬運工人） Non-technician (e.g. cleaners, property management officers, postpersons, porters)</p> <p>(10) 其他 Others</p> <p>(11) 待業 Unemployed</p> <p>(12) 家庭主婦/夫 housewife/househusband</p>	<input type="checkbox"/>

老年人(60~79歲)
Adults (aged 60~79)

<p>14.近5年曾患過何種疾病（經醫院確診的疾病）（選擇“無”者請直接回答問題第16題） Hospital-diagnosed diseases suffered within the past 5 years (If the answer is “no”, skip to Question 16)</p> <p>(1) 有 (2) 無 Yes No</p>			<input type="checkbox"/>
<p>15.患病種類（患病者按主次順序，最多可填寫3項） Diseases suffered (in order of precedence, choose up to 3 diseases)</p>			<input type="checkbox"/> <input type="checkbox"/> <input type="checkbox"/>
(1) 急性支氣管炎 Acute bronchitis	(2) 肺炎 Pneumonia	(3) 腸炎、胃炎 Enteritis, gastritis	
(4) 胃潰瘍 Gastric ulcer	(5) 咽喉炎 Pharyngitis	(6) 鼻炎 Rhinitis	
(7) 中耳炎 Otitis media	(8) 結膜炎、乾眼症 Conjunctivitis, dry eye syndrome	(9) 牙周炎 Periodontitis	
(10) 膽結石、慢性膽囊炎 Gallstone, chronic cholecystitis	(11) 過敏性皮炎 Allergic dermatitis	(12) 腳癬 Tinea pedis	
(13) 尿道炎 Urethritis	(14) 陰道炎、宮頸炎 Coleitis, cervicitis	(15) 風疹、麻疹、水痘 Rubella, measles, varicella	
(16) 貧血 Anemia	(17) 糖尿病 Diabetes	(18) 高血脂 Hyperlipemia	
(19) 高血壓 Hypertension	(20) 心臟病 Heart disease	(21) 腦卒中 Cerebral stroke	
(22) 腫瘤 Tumor	(23) 類風濕性關節炎 Rheumatoid arthritis	(24) 椎間盤疾病 Discopathy	
(25) 腎炎 Nephritis	(26) 肝炎 Hepatitis	(27) 長期失眠 Long-term insomnia	
(28) 意外傷害(造成人體的損傷而需要醫治或影響了正常的活動) Accidental injury (injury to the body that needs treatments, or injury that affects normal activities)	(29) 其他 Others		
<p>16.在此之前，是否聽說過“體質測定” Have you ever heard of the “Physical Fitness Study”?</p> <p>(1) 是 (2) 否 Yes No</p>			<input type="checkbox"/>
<p>17.在此之前，是否參加過“體質測定” Have you ever participated in the “Physical Fitness Study”?</p> <p>(1) 是 (2) 否 Yes No</p>			<input type="checkbox"/>

2020年澳門市民體質監測數據登錄冊

Data Registration Manual of
2020 Physical Fitness Study of Macao SAR Residents

18. 對“體質測定”的認識（按照主次順序，最多選3項）

What is your understanding of the “Physical Fitness Study”?
(in order of precedence, at most 3 options)

--	--	--

- (1) 無意義
Meaningless
- (2) 瞭解自己的體質狀況
To understand the physical fitness status of oneself
- (3) 認識體育鍛煉的重要性
To recognize the importance of physical exercising
- (4) 增長科學健身知識
To improve knowledge of scientific fitness

老年人(60~79歲)
Adults (aged 60~79)

二. 健身素養問卷 Fitness Literacy

A-知識、認知和態度 Knowledge, cognition and attitude

A1. 【單選題】您認為以下說法是否正確，正確選1、不正確選2、不知道選3，並在您選的數字上畫“○”。

[Single choice question] Which of the following descriptions do you think are correct? Choose 1 for “Correct”, 2 for “Incorrect”, 3 for “Don’t know”, and circle each corresponding number with “○”.

題目 Question	正確 Correct	不正確 Incorrect	不知道 Don't know
1) 清晨是鍛煉的最佳時間 Morning is the best time for physical exercise.	1	2	3
2) 運動鍛煉有助於降低老年人跌倒及跌倒引起的骨折風險 Physical exercise helps to reduce the risks of falling and fall-related fractures in the elderly.	1	2	3
3) 吃飯後需要休息約30分鐘再去散步 A 30 minute rest is needed after eating before going for a walk.	1	2	3
4) 跑步應該選擇堅硬平坦的地面 Choose hard and flat ground when running.	1	2	3
5) 各種心臟疾病的急性階段和體溫增高的急性疾病，如急性心肌梗塞患者、上呼吸道感染發熱的患者不宜參加體育鍛煉 Patients of any acute heart diseases or other acute diseases with increased body temperature, such as acute myocardial infarction, upper respiratory tract infection and fever, should not participate in physical exercise.	1	2	3
6) 體育鍛煉時最好穿純棉服裝 It is best to wear pure cotton clothing when exercising.	1	2	3
7) 游泳後不能立刻吃東西 Don't eat right after swimming.	1	2	3
8) 運動處方是指針對某一類人群的身體狀況，採用處方的形式規定健身者鍛煉的內容和運動量的方法 Exercise prescription is used to specify the content and amount of exercise in the form of prescription, according to the physical condition of a targeted group.	1	2	3
9) 負重訓練可加強骨骼密度，預防骨質疏鬆，減少骨折的風險，如跑步、快走、跳繩等 Weight training can strengthen bone density, prevent osteoporosis and fractures, such as running, brisk walking, rope skipping, etc.	1	2	3
10) 有氧運動是人體在氧氣充分供應的情況下進行運動強度低、運動時間較長且富韻律性的體育鍛煉，如游泳、慢跑。 Aerobic exercise is a kind of rhythmic exercise that is low intensity and long duration under the condition of sufficient oxygen supply, such as swimming and jogging.	1	2	3

2020年澳門市民體質監測數據登錄冊

Data Registration Manual of
2020 Physical Fitness Study of Macao SAR Residents

A2. 【單選題】以下說法您是否同意，非常不贊同選1、不太贊同選2、一般選3、比較贊同選4、非常贊同選5，並在您選的數字上畫“○”。

【Single choice question】 Which of the following descriptions do you agree with? Choose 1 for “Strongly disagree”, 2 for “Slightly disagree”, 3 for “Neutral”, 4 for “Relatively agree”, 5 for “Strongly agree”, and circle each corresponding number with “○”.

題目 Question	非常不贊同 Strongly disagree	不太贊同 Slightly disagree	一般 Neutral	比較贊同 Relatively agree	非常贊同 Strongly agree
1) 總體來評價，健身活動是一項積極向上的活動 Generally speaking, fitness activity is an activity that is positive.	1	2	3	4	5
2) 健身活動有益於保持身體健康 Fitness activity is good for body health.	1	2	3	4	5
3) 健身活動可以舒緩孤獨、鬱悶的情緒 Fitness activity can relieve anxiety or depression.	1	2	3	4	5
4) 健身活動可以增強人的意志 Fitness activity can hone the will.	1	2	3	4	5
5) 健身活動是無趣的 Fitness activity is boring.	1	2	3	4	5
6) 健身活動是非常值得去做的活動 Fitness activity is well worth doing.	1	2	3	4	5
7) 健身是我生活中可以缺少的一部分 Exercising is a part of my life that I can live without.	1	2	3	4	5
8) 不管多忙，都應該抽時間去健身 We should spare time for exercising no matter how busy we are.	1	2	3	4	5
9) 把錢花在健身方面是值得的 Spending money on exercising is worthwhile.	1	2	3	4	5
10) 我願意說服周圍的人同我一起健身 I would like to persuade others to work out with me.	1	2	3	4	5

老年人(60~79歲)
Adults (aged 60~79)

A3. 【單選題】 下面的說法是否符合您的實際情況？非常不符合選1、不太符合選2、一般選3、比較符合選4、非常符合選5，並在您選的數字上畫“○”。

【Single choice question】 Which of the following descriptions is accurate according to your situation? Choose 1 for “Very inconsistent”, 2 for “Not quite consistent”, 3 for “Neutral”, 4 for “Slightly consistent”, 5 for “Very consistent”, and circle each corresponding number with “○”.

題目 Question	非常不符合 Very inconsistent	不太符合 Not quite consistent	一般 Neutral	比較符合 Slightly consistent	非常符合 Very consistent
1) 我已經掌握的體育鍛煉技能是正確的、科學的 I think the exercising skills that I have acquired are correct and scientific.	1	2	3	4	5
2) 已經或正準備去瞭解、諮詢一下體育健身的專業人士（如體育老師、健身教練、電視節目），聽一下他們的專業意見 I have visited or am planning to consult with sports and fitness professionals (e.g., PE teachers, fitness coaches, TV shows) and get their professional advice.	1	2	3	4	5

2020年澳門市民體質監測數據登錄冊

Data Registration Manual of
2020 Physical Fitness Study of Macao SAR Residents

B-健身技能 Fitness skills

B1.【多選排序題】體育鍛煉的主要項目有哪些？本題為多選題，可選1個或1個以上的答案，請圈選所有您主要參加的體育鍛煉項目，在選項對應的序號上畫“○”，並按照經常參加的頻率由高到低排序後將對應序號填寫如下：、、、、、、、、、、、。如果沒有參加過任何運動項目只圈選33即可。

【Multiple-choice sorting question】 What are the physical exercises in which you frequently participated? This is a multiple choice question, you need to choose at least 1 or more option(s). Choose the physical exercises you have frequently participated, circle the corresponding number with “○”, and fill in the blanks in descending order of frequency as follows: , , , , , , , , , , , . If your answer is “None”, circle the number 33.

1	步行（健步走） Walking (Brisk walking)	12	門球、地擲球 Gate ball, bocce ball	23	騎自行車 Cycling
2	跑步 Running	13	高爾夫球 Golf	24	瑜伽、普拉提 Yoga, Pilates
3	跳高 High jump	14	柔力球 Softball	25	力量、健美（徒手、器械） Strength exercises, body building (bodyweight training, equipment workout)
4	跳遠 Long jump	15	健身操類（體操、健美操等） Aerobics (such as gymnastics, aerobics, etc.)	26	滑冰 Skating
5	登山、攀岩 Hiking, rock climbing	16	舞蹈類（廣場舞、民族舞等） Dancing (such as square dance, folk dance, etc.)	27	滑雪 Skiing
6	籃球 Basketball	17	武術（武術套路、太極、木蘭等） Martial arts (such as series of skills, taiji, mulan, etc.)	28	游泳 Swimming
7	排球 Volleyball	18	健身氣功（易筋經、八段錦、五禽戲、 六字訣等） Qigong (such as yijinjing, baduanjin, wuqinxi, liuzijue, etc.)	29	跳繩 Rope skipping
8	足球 Football	19	拳擊、摔跤、散打 Boxing, wrestling, free combat	30	踢毽 Shuttlecock kicking
9	網球 Tennis	20	跆拳道 Taekwondo	31	輪滑 Roller skating
10	乒乓球 Table tennis	21	空手道 Karate	32	其他 Other
11	羽毛球 Badminton	22	柔道 Judo	33	沒有參加過任何運動項目 （不用回答B2、C1題） None (skip Questions B2, C1)

老年人(60~79歲)
Adults (aged 60~79)

B2. 【多選排序題】您能夠熟練掌握的體育鍛煉項目有哪些（熟練是指自己能掌握某項運動的基本技能和基本比賽規則）？本題為多選題，可選1個或1個以上的答案，請圈選所有您熟練掌握的運動項目，在選項對應的序號上畫“○”，按照熟練程度排序後將對應序號填寫如下：

、、、、、、、、。如果沒有熟練掌握的項目只圈選33即可。

【Multiple-choice sorting question】 What kinds of physical exercises are you proficient at (Proficiency means that you have acquired the basic skills and basic competition rules of the exercise)? This is a multiple choice question, you need to choose at least 1 or more option(s). Choose all the physical exercises in which you are proficient at, circle the corresponding number with “○”, and fill in the blanks in descending order of proficiency as follows: , , , , , , , , . If your answer is “None”, circle the number 33.

1	步行（健步走） Walking (Brisk walking)	12	門球、地擲球 Gate ball, bocce ball	23	騎自行車 Cycling
2	跑步 Running	13	高爾夫球 Golf	24	瑜伽、普拉提 Yoga, Pilates
3	跳高 High jump	14	柔力球 Softball	25	力量、健美（徒手、器械） Strength exercises, body building (bodyweight training, equipment workout)
4	跳遠 Long jump	15	健身操類（體操、健美操等） Aerobics (such as gymnastics, aerobics, etc.)	26	滑冰 Skating
5	登山、攀岩 Hiking, rock climbing	16	舞蹈類（廣場舞、民族舞等） Dancing (such as square dance, folk dance, etc.)	27	滑雪 Skiing
6	籃球 Basketball	17	武術（武術套路、太極、木蘭等） Martial arts (such as series of skills, taiji, mulan, etc.)	28	游泳 Swimming
7	排球 Volleyball	18	健身氣功（易筋經、八段錦、五禽戲、 六字訣等） Qigong (such as yijinjing, baduanjin, wuqinxi, liuzijue, etc.)	29	跳繩 Rope skipping
8	足球 Football	19	拳擊、摔跤、散打 Boxing, wrestling, free combat	30	踢毽 Shuttlecock kicking
9	網球 Tennis	20	跆拳道 Taekwondo	31	輪滑 Roller skating
10	乒乓球 Table tennis	21	空手道 Karate	32	其他 Other
11	羽毛球 Badminton	22	柔道 Judo	33	沒有熟練掌握的項目 None

2020年澳門市民體質監測數據登錄冊

Data Registration Manual of
2020 Physical Fitness Study of Macao SAR Residents

B3. 【多選題】 您知道運動前要做的準備活動有哪些？本題為多選題，可選1個或1個以上的答案，請圈選所有您知道的準備活動，在選項對應的序號上畫“○”。如果沒有知道的準備活動只圈選10即可。）

【Multiple choice question】 What kinds of warm-up exercises should be done before exercising? This is a multiple choice question, you need to choose at least 1 or more option(s). Choose all the warm-up exercises you know, and circle each corresponding number with “○”. If your answer is “None”, circle the number 10.

1	慢跑 Jogging	6	壓腿（包括前壓腿和側壓腿） Leg stretch (including forward lunge stretch and side lunge stretch)
2	腰部運動（如扭腰） Waist movement (such as waist twisting)	7	體前屈 Forward bend
3	肩部運動（轉動肩膀） Shoulder movement (rolling shoulders)	8	原地高抬腿 High-knee running in place
4	關節活動（包括手腕關節、頸關節和腳踝關節） Joint movement (including wrist, neck and ankle joints)	9	其他 Others
5	擴胸運動 Chest expansion exercise	10	沒有知道的準備活動（不用回答B4題） None (skip Question B4)

B4. 【多選題】 您能夠熟練掌握的準備活動有哪些（熟練是指自己獨立會做某項準備活動）？本題為多選題，可選1個或1個以上的答案，請圈選所有您熟練掌握的準備活動，在選項對應的序號上畫“○”。如果沒有熟練掌握的準備活動只圈選10即可。

【Multiple choice question】 What kinds of warm-up exercises are you proficient at (Proficiency means that you would conduct the warm-up exercise when on your own)? This is a multiple choice question, you need to choose at least 1 or more option(s). Choose all the warm-up exercises in which you are proficient at, and circle each corresponding number with “○”. If your answer is “None”, circle the number 10.

1	慢跑 Jogging	6	壓腿（包括前壓腿和側壓腿） Leg stretch (including forward lunge stretch and side lunge stretch)
2	腰部運動（如扭腰） Waist movement (such as waist twisting)	7	體前屈 Forward bend
3	肩部運動（轉動肩膀） Shoulder movement (rolling shoulders)	8	原地高抬腿 High-knee running in place
4	關節活動（包括手腕關節、頸關節和腳踝關節） Joint movement (including wrist, neck and ankle joints)	9	其他 Others
5	擴胸運動 Chest expansion exercise	10	沒有熟練掌握的準備活動 None

老年人(60~79歲)
Adults (aged 60~79)

B5. 【單選題】 下面的說法是否符合您的實際情況？非常不符合選1、不太符合選2、一般選3、比較符合選4、非常符合選5，並在您選的數字上畫“○”。

【Single choice question】 Which of the following descriptions is accurate according to your situation? Choose 1 for “Very inconsistent”, 2 for “Not quite consistent”, 3 for “Neutral”, 4 for “Slightly consistent”, 5 for “Very consistent”, and circle each corresponding number with “○”.

題目 Question	非常不符合 Very inconsistent	不太符合 Not quite consistent	一般 Neutral	比較符合 Slightly consistent	非常符合 Very consistent
1) 能夠結合自己的情況選擇適合自己的體育鍛煉項目 I can choose physical exercises that suit me.	1	2	3	4	5
2) 能夠根據自身狀況合理的制定健身計劃 I can reasonably develop a fitness plan based on my actual condition.	1	2	3	4	5
3) 能夠根據實際情況及時對健身計劃作出調整 I can promptly adjust my fitness plan based on my actual condition.	1	2	3	4	5

B6. 【單選題】 下面的說法是否符合您的實際情況？非常不符合選1、不太符合選2、一般選3、比較符合選4、非常符合選5，並在您選的數字上畫“○”。

【Single choice question】 Which of the following descriptions is accurate according to your situation? Choose 1 for “Very inconsistent”, 2 for “Not quite consistent”, 3 for “Neutral”, 4 for “Slightly consistent”, 5 for “Very consistent”, and circle each corresponding number with “○”.

題目 Question	非常不符合 Very inconsistent	不太符合 Not quite consistent	一般 Neutral	比較符合 Slightly consistent	非常符合 Very consistent
1) 對於喜歡的健身項目，您認為已經很好地掌握了該健身項目所要求的技能 I think I have adequately acquired the skills of exercises that I like.	1	2	3	4	5
2) 只要自己願意，您可以堅持進行健身活動 I can persist in exercising if I want to.	1	2	3	4	5

2020年澳門市民體質監測數據登錄冊

Data Registration Manual of
2020 Physical Fitness Study of Macao SAR Residents

C-習慣養成 Habit formation

C1. 【單選題】您是如何選中B1題中的這些體育鍛煉項目的？請在您選中的選項對應的序號上畫“○”。

【Single choice question】 How did you choose the physical exercises in Question B1? Choose the proper answer and circle its corresponding number with “○”.

1	自己隨便選的 I chose them randomly	4	跟著家人、朋友或同事等選的 I followed the choices of my family members, friends or colleagues.
2	哪些項目練起來方便就選哪些 I chose them because they are convenient to do.	5	哪些項目容易就選哪些 I chose them because they are easy to do.
3	跟著潮流走的 Follow the general trend.	6	諮詢過專業意見 I chose them after seeking for professional advice.

C2. 【限選排序題】阻礙您開展體育鍛煉的原因是甚麼？本題為限選排序題，請圈選出3個對您來說最主要的原因，在選項對應的序號上畫“○”，並依據重要程度由高到低進行排序後將序號依次填寫在以下方框上：、、。

【Three-choice sorting question】 What are the main obstacles to your participation in physical exercise? This is a three-choice sorting question, choose the top 3 reasons, circle each corresponding number with “○”, and fill in the blanks in order of precedence as follows: , , .

1	工作忙 Busy work	7	沒有健身場地 Lack of suitable venues
2	家務忙 Too many house chores	8	健身場地距離太遠 Lack of fitness venues nearby
3	怕受傷 To avoid physical injury	9	周邊缺少體育健身組織 Lack of fitness clubs nearby
4	經濟條件不允許 Financial restraint	10	群眾性的健身賽事或者活動太少 Lack of events or activities for residents
5	對體育鍛煉沒有興趣 Lack of interest	11	社區組織開展的活動項目少，缺乏吸引力 Lack of such activities in community, or activities less attractive
6	不知道該怎麼鍛煉，缺乏指導 Lack of coaching advice	12	其他 Others

老年人(60~79歲)
Adults (aged 60~79)

- C3. 【單選題】您現在的工作狀態（是指您的職業活動，含義工或志願者工作但不包含家庭主婦/夫所從事的家務工作）如何？請在您選中的選項對應的序號上畫“○”，如果選擇1則同時填寫下方框的內容。

【Single choice question】 What is your current work status (i.e. your profession's activities, including volunteer work, but not including house chores conducted as housewives/husbands)? Choose the proper answer and circle its corresponding number with “○”, If you choose Option 1, fill in the blanks with answers.

1	每週工作 I work	<input type="text"/>	天，平均每天工作 hours per day,	<input type="text"/>	小時 days per week.
2	有工作但不定時 No regular work				
3	不工作（不用回答C4題） Unemployed (skip Question C4)				

- C4. 【填空題】您工作中的體力活動狀況如何？請認真讀題後，在“ ”處填寫您的實際情況，如果沒有以下情況的請填“0”。注：填寫時間通常為10的倍數。

【Blank-filling question】 What is the labor intensity of your daily work? Read the question carefully, and fill in the blanks “ ” according to your actual conditions. If it is not applicable, write “0”. Note: The number you fill in should be a multiple of 10.

- 1) 您的工作中通常每週有多少天會做“呼吸和心跳顯著增加（如搬運或舉重物、挖掘或建築工作等）”持續時間10分鐘以上的劇烈活動？ 天；您通常一天工作中累計做多長時間的這種持續10分鐘以上的劇烈活動？ 分鐘。

How many days in a typical week at work do you do vigorous activities (e.g. manual load handling or lifting, digging or construction work) lasting for more than 10 minutes with “significantly increased breathing and heart rate”? days; What is the average cumulative time you spent on doing such vigorous activities lasting for more than 10 minutes at work in a typical day? minutes.

- 2) 您的工作中通常每週有多少天會做“呼吸和心跳輕度增加（如快步走、搬運較輕的物品）”持續時間10分鐘以上的中等強度活動？ 天；您通常一天工作中累計做多長時間的這種持續10分鐘以上的中等強度活動？ 分鐘。

How many days in a typical week at work do you do moderate-intensity activities (e.g. brisk walking, manual handling of light objects) lasting for more than 10 minutes with “slightly increased breathing and heart rate”? days; What is the average cumulative time you spent doing such moderate-intensity activities lasting for more than 10 minutes at work in a typical day? minutes.

- C5. 【填空題】您通常每天有多少時間坐著或者靠著？注：填寫分鐘通常為10的倍數。

【Blank-filling question】 What is your average sitting or reclining time per day? Note: The number you fill in should be a multiple of 10.

請填寫： 小時 分鐘。
Please fill in the blanks: hours minutes

2020年澳門市民體質監測數據登錄冊

Data Registration Manual of
2020 Physical Fitness Study of Macao SAR Residents

C6. 【**填空題**】您通常每天睡眠（包括午睡）多少時間？注：填寫分鐘通常為10的倍數。

【Blank-filling question】What is your average sleep time (including naps) per day? Note: The number you fill in should be a multiple of 10.

請填寫： 小時 分鐘。
Please fill in the blanks: hours minutes

C7. 【**單選題**】您通常最主要的交通出行方式是甚麼？請在您選中選項對應的序號上畫“○”。

【Single choice question】What is your major means of transportation? Choose the proper answer and circle its corresponding number with “○”.

1	步行 On foot	4	駕車 Driving
2	騎自行車 Bicycling	5	乘公共交通、乘坐私家車或乘坐電單車等 By public transport, private car or motorcycle
3	騎電單車 Motorcycling	6	其他 Others

C8. 【**填空題**】您通常每週有多少天的出行交通方式為步行或騎自行車持續時間10分鐘以上（出行指的是去上班、購物、參加聚會等，但不包括專為體育鍛煉而進行的步行或者騎行。）？天；您通常一天在交通方面累計花多長時間這種持續10分鐘以上的步行或者騎自行車？分鐘。注：填寫時間通常為10的倍數；如果沒有這種情況的請填“0”。

【Blank-filling question】How many days do you walk or bicycle for at least 10 minutes continuously in a typical week (It refers to the total time spent commuting to work, shopping and attending parties, etc., but do not include walking or bicycling specifically for exercising)? days; What is the average cumulative commuting time you spent walking or bicycling at least 10 minutes continuously in a typical day? minutes. Note: The number you fill in should be a multiple of 10; if it is not applicable, write “0”.

C9. 【**填空題**】您在做家務過程中的體力活動狀況如何？請認真讀題後，在“”處填寫您的實際情況，如果沒有以下情況的請填“0”。注：填寫時間通常為10的倍數。

【Blank-filling question】What is the labor intensity of your daily house chores? Read the question carefully, and fill in the blanks “” according to your actual conditions. If it is not applicable, write “0”. Note: The number you fill in should be a multiple of 10.

1) 您生活中通常每週有多少天會從事持續時間10分鐘以上、大強度的家務勞動（比如搬提重物、庭院挖土等）？天；平均一天累計會做多長時間這種持續10分鐘以上的大強度家務勞動？分鐘。

How many days in a typical week do you do high-intensity house chores (e.g. manual load handling or lifting, digging in the yard, etc.) lasting for more than 10 minutes?

days; What is the average cumulative time you spent doing such high-intensity house chores lasting for more than 10 minutes in a typical day? minutes

老年人(60~79歲)
Adults (aged 60~79)

- 2) 您生活中通常每週有多少天會從事持續時間10分鐘以上、中等強度的家務勞動（比如搬提輕物、擦窗、擦地、打掃房間等）？天；平均一天累計會做多長時間這種持續10分鐘以上的中等強度家務勞動？分鐘。

How many days in a typical week do you do moderate-intensity house chores (e.g. handling or lifting light objects, wiping the window, mopping the floor, cleaning the room, etc.) lasting for more than 10 minutes? days; What is the average cumulative time you spent doing such moderate-intensity house chores lasting for more than 10 minutes in a typical day? minutes

- C10. 【限選排序題】請問您通常會從事哪些閒暇活動？本題為限選排序題，請圈選出3件最經常做的事，在選項對應的序號上畫“○”，並依據花費時間由長到短進行排序後將序號依次填寫在以下方框上：、、。

【Three-choice sorting question】 What leisure-time activities do you usually do? This is a three-choice sorting question, choose the top 3 activities you most frequently do, circle each corresponding number with “○”, and fill in the blanks in descending order of time spent as follows:

, , .

1 看電視 Watching TV	8 園藝、照顧寵物 Garden work, pet caring	15 手工（編制、刺繡、陶藝） Doing handwork (knitting, embroidery, pottery)
2 聽廣播、音樂 Listening to radio and music	9 遛狗 Walking my dog	16 到現場觀看體育比賽 Watching sports event on site
3 玩電腦/手機/遊戲機 Using computers/mobile/ game console	10 唱歌、唱戲 Karaoke	17 郊遊 Outing
4 讀書、看報 Reading books and newspaper	11 逛街、遊玩 Hanging out	18 補充睡眠 Napping
5 打牌、下棋 Playing chess or poker	12 做家務 Doing house chores	19 陪孩子玩 Accompanying my child
6 聊天、聚會 Chatting, social gathering	13 書法、繪畫、彈琴 Calligraphy, painting, playing music instrument	20 陪孩子做功課及復習 Assisting my child with homework
7 體育鍛煉 Exercising	14 看演出/電影 Watching shows/movies	21 其他 Others

- C11. 【單選題】您日常參加體育鍛煉的頻率如何？請在您選中的選項對應的序號上畫“○”。

【Single choice question】 What is your exercise frequency? Choose the proper answer and circle its corresponding number with “○”.

1 平均每週7次或以上 7 times or more on average per week	6 平均每週2次 Twice a week on average
2 平均每週6次 6 times on average per week	7 平均每週1次 Once a week on average
3 平均每週5次 5 times on average per week	8 平均每月1次或以上，但每週不足1次 Once or more per month, but less than once a week on average
4 平均每週4次 4 times on average per week	9 平均每月不足1次 Fewer than once a month
5 平均每週3次 3 times on average per week	10 從不參加體育鍛煉（不用回答C12至C16題） Never (skip Questions C12-C16)

2020年澳門市民體質監測數據登錄冊

Data Registration Manual of
2020 Physical Fitness Study of Macao SAR Residents

C12. 【單選題】多數情況下，您每次能鍛煉多長時間？請在您選中的選項對應的序號上畫“○”。

【Single choice question】What is your exercise duration each time in most cases? Choose the proper answer and circle its corresponding number with “○”.

1	10分鐘以下 Less than 10 minutes	4	30至59分鐘 30-59 minutes
2	10~19分鐘 10-19 minutes	5	60至119分鐘 60-119 minutes
3	20~29分鐘 20-29 minutes	6	120分鐘或以上 120 minutes or more

C13. 【單選題】多數情況下，您每次進行體育鍛煉時的身體感受是甚麼樣的？請在您選中的選項對應的序號上畫“○”。

【Single choice question】In most cases, how do you feel physically during exercising? Choose the proper answer and circle its corresponding number with “○”.

1	呼吸、心跳變化不大 Unchanged breathing and heart rate	2	呼吸、心跳加快，微微出汗 Slightly increased breathing, heart rate and slight sweating	3	呼吸急促，心跳明顯加快，出汗較多 Significantly increased breathing, heart rate and increased sweating
---	---	---	--	---	--

C14. 【填空題】您每週參加體育鍛煉的具體情況如何？請認真讀題後，在“”處填寫您的實際情況，如果沒有以下情況或不能每週都做，可以填“0”。注：填寫時間通常為10的倍數。

【Blank-filling question】What are your actual conditions when you do physical exercises each week? Read the question carefully, and fill in the blanks “” according to your actual conditions. If it is not applicable, write “0”. Note: The number you fill in should be a multiple of 10.

1) 您平均每週有多少天從事每次持續時間10分鐘以上的呼吸心跳明顯加快、出汗較多的大強度體育鍛煉？天；平均一天次；平均每次分鐘。

How many days in a typical week do you do high-intensity physical exercises lasting for more than 10 minutes with significantly increased breathing, heart rate and more sweating?
 day(s) a week; time(s) a day; minutes each time.

2) 您平均每週有多少天從事每次持續時間10分鐘以上的呼吸心跳加快、微微出汗的中等強度體育鍛煉？天；平均一天次；平均每次分鐘。

How many days in a typical week do you do moderate-intensity physical exercises lasting for more than 10 minutes with slightly increased breathing, heart rate and slight sweating?
 day(s) a week; time(s) a day; minutes each time.

老年人(60~79歲)
Adults (aged 60~79)

C15. 【單選題】按上述C11~C14題選擇的頻率、時間及強度開展體育鍛煉，您堅持了多長時間？請在您選中的最接近的選項對應的序號上畫“○”。

【Single choice question】 How long have you keep on exercising as per the exercise frequency, duration and intensity chosen in Questions C11~C14? Choose the proper answer and circle its corresponding number with “○”.

1	沒有 N/A	3	1個月或以上，但不足3個月 1 month or more, but less than 3 months	5	半年或以上，但不足1年 Half a year or more, but less than 1 year
2	不足1個月 Less than 1 month	4	3個月或以上，但不足半年 3 months or more, but less than half a year	6	1年或以上 1 year or more

C16. 【單選題】您通常每週有幾天進行力量練習(包括俯臥撐、仰臥起坐、引體向上、深蹲等徒手練習或使用啞鈴、彈力帶等健身器械的練習)？請在您選中的選項對應的序號上畫“○”。

【Single choice question】 How many days a week do you usually do strength training (including bodyweight training such as push-ups, sit-ups, pull-ups, and squats, or equipment workout such as using dumbbells and elastic bands)? Choose the proper answer and circle its corresponding number with “○”.

1	1天 1 day	5	5天 5 days
2	2天 2 days	6	6天 6 days
3	3天 3 days	7	7天 7 days
4	4天 4 days	8	0天 0 day

問卷完畢。謝謝。

This is the end of the questionnaire.
Thank you for participating.

2020年澳門市民體質監測數據登錄冊

Data Registration Manual of
2020 Physical Fitness Study of Macao SAR Residents

三. 檢測指標 (由監測人員在監測現場填寫)

Testing indicators (to be filled in by examiner on site)

1. 身高 (cm) Height (cm)	<input type="text"/> <input type="text"/> <input type="text"/> . <input type="text"/>
2. 坐高 (cm) Sitting height (cm)	<input type="text"/> <input type="text"/> . <input type="text"/>
3. 體重 (kg) Weight (kg)	<input type="text"/> <input type="text"/> <input type="text"/> . <input type="text"/>
4. 胸圍 (cm) Chest circumference (cm)	<input type="text"/> <input type="text"/> <input type="text"/> . <input type="text"/>
5. 腰圍 (cm) Waist circumference (cm)	<input type="text"/> <input type="text"/> <input type="text"/> . <input type="text"/>
6. 臀圍 (cm) Hip circumference (cm)	<input type="text"/> <input type="text"/> <input type="text"/> . <input type="text"/>
7. 體脂率 (%) Body fat percentage (%)	<input type="text"/> <input type="text"/> . <input type="text"/>
8. 肩寬 (cm) Shoulder width (cm)	<input type="text"/> <input type="text"/> . <input type="text"/>
9. 骨盆寬 (cm) Pelvis width (cm)	<input type="text"/> <input type="text"/> . <input type="text"/>
10. 足長 (cm) Foot length (cm)	<input type="text"/> <input type="text"/> . <input type="text"/>
11. 安靜脈搏 (次/分) Resting pulse (bpm)	<input type="text"/> <input type="text"/> <input type="text"/>
12. 收縮壓 (mmHg) Systolic blood pressure (mmHg)	<input type="text"/> <input type="text"/> <input type="text"/>
13. 舒張壓 (mmHg) Diastolic blood pressure (mmHg)	<input type="text"/> <input type="text"/> <input type="text"/>

老年人(60~79歲)
Adults (aged 60~79)

14.肺活量 (ml) Vital capacity (ml)	<input type="text"/> <input type="text"/> <input type="text"/> <input type="text"/>
15.握力 (kg) Grip strength (kg)	<input type="text"/> <input type="text"/> . <input type="text"/>
16.閉眼單腳站立 (秒) One foot stands with eyes closed (OFSEC) (sec)	<input type="text"/> <input type="text"/> <input type="text"/>
17.選擇反應時 (秒) Choice reaction time (sec)	<input type="text"/> . <input type="text"/> <input type="text"/>
18.坐位體前屈 (cm) Sit and reach (cm)	<input type="text"/> <input type="text"/> <input type="text"/> . <input type="text"/>
19.2分鐘原地高抬腿 (次) 2-minute high-knee running in place (times)	<input type="text"/> <input type="text"/> <input type="text"/>
20.30秒坐站 (次) 30-second chair stand (times)	<input type="text"/> <input type="text"/> <input type="text"/>

檢驗員簽署：
Examiner Signature : _____

Appendix 2: Methods for Filling out “2020 Physical Fitness Study of Macao SAR Residents” Questionnaire

I. Basic Information

Name, gender and age must be honestly filled out since they are important information used to classify subjects into different categories and to file data registration manuals. This information could be filled in either by the subjects themselves or by the examiners before examination. When filling, examiners need to ensure the accuracy and integrity of the information. If any uncertainties occurred, they should clarify with the subjects. All questions must be filled. After the examination, these manuals should be filed and stored according to genders and age groups in a timely manner. Requirements for filling out the first page of the manual are as follows:

1. Name and Gender

Valid information should be filled in.

2. Age

Age should be filled based on date of birth and examination date. Refer to “(II) Sampling Principles and Methods” of Part I Physical Fitness Study and Implementation for calculations of age (years).

3. Name of Attending Kindergartens, Schools, Work Units and Affiliated Units and Contact Number

Names of attending kindergartens, schools, work units and affiliated units should be honestly filled based on the subjects’ actual situations. For seniors, name of senior agency should be written down.

Contact number should be one that is most commonly used by subjects.

4. Explanations

Before examination, the subjects should be reminded to read and understand the explanations in the manuals in order to understand the work of the study.

II. Category by Code

1. Macao ID Card Number

Subjects should provide valid information.

2. Gender

The national gender code system was adopted. 1 represents male and 2 represents female.

3. Date of Birth and Examination Date

Dates should be filled according to western calendar. Examination date refers to the date the subject first participated in the examination and would be filled in by the examiners. Methods for filling are as follows:

Fill in the year in the first to fourth boxes, the fifth and sixth boxes for month (if subjects were born from January to September, the fifth box should be “0”), the seventh and eighth boxes for day (if subjects were born on dates ranging from 1st to 9th, the seventh box should be “0”).

E.g.: The subject was born on 12th April, 1964 and the examination date was 12th April, 2020, the manual should be filled in as follows:

Date of birth:

1	9	6	4
---	---	---	---

 Y

0	4
---	---

 M

1	2
---	---

 D

Examination date:

2	0	2	0
---	---	---	---

 Y

0	4
---	---

 M

1	2
---	---

 D

4. Code Number of Kindergartens, Schools, Work Units and Affiliated Units

Before examination, participating institutes were coded by the Physical Fitness Monitoring Centre for Macao Residents with numbers and they were registered and saved accordingly.

Coding: (1) 4-digit code numbers were used in 2020. The first digit indicates the year of the Study, the second digit indicates whether the institute was a newly added sampling site, the third and fourth digits represent the code of the sampling sites. (2) 2005 was the year of the first study, the original codes were all 2-digit numbers. (3) 2010 Coding rules: for sampling sites already participated in 2005, “0” was added in addition to the original code numbers. Kindergartens code numbers: 001~020. Schools code numbers: 021~040. Work units code numbers: 041~070. Senior agencies code numbers: 071~099. The newly increased sampling sites in 2010 were coded in sequence. Kindergartens code numbers: 101~120. Schools code numbers: 121~140. Work units code numbers: 141~170. Senior agencies code numbers: 171~199. (4) 2015 Coding rules: for sampling sites already participated in 2010, if the first digit was “0”, revise it to “2”; if the first digit was “1”, “2” should be added to the code numbers. Kindergartens code numbers: 201~220 or 2101~2120. Schools code numbers: 221~240 or 2121~2140. Work units code numbers: 241~270 or 2141~2170. Senior agencies code numbers: 271~299 or 2171~2199. The newly increased sampling sites in 2015 were coded in sequence, with the first digit being “3”. Kindergartens code numbers: 301~320. Schools code numbers: 321~340. Work units code numbers: 341~370. Senior agencies code numbers: 371~399. (5) 2020 Coding: for all participating sampling sites in 2020, the first digit was “4”, the second digit was “0” for the original sampling sites in 2005, “1” for the newly increased sampling sites in 2010, “2” for the newly increased sampling sites in 2015, and “3” for the newly increased sampling sites in 2020. The third and fourth digits were the code numbers of sampling sites. Kindergartens code numbers: 01~20, schools code numbers: 21~40, work units code numbers: 41~70, senior agencies code numbers: 71~99.

E.g.: The code number for Macao University of Science and Technology was “228” (**original sampling site in 2005**), then the boxes should be filled as:

4	0	2	8
---	---	---	---

E.g.: The code number for some other university/college was “2121” (**newly increased sampling site in 2010**), then the boxes should be filled as:

4	1	2	1
---	---	---	---

E.g.: The code number for SJM Holdings Limited was “342” (**newly increased sampling site in 2015**), then the boxes should be filled as:

4	2	4	2
---	---	---	---

E.g.: The code number for Wynn Resorts (Macao) was “4341” (**newly increased sampling site in 2020**), then the boxes should be filled as:

4	3	4	1
---	---	---	---

5. Serial Number

Serial number refers to the subject's code number. Supervised by the Physical Fitness Monitoring Centre for Macao Residents, subjects were coded according to four categories: young children, students, adults and seniors. Among each category were classified into groups based on age and genders. All examination teams should have each and every subject's serial number saved for future reference. The serial number ranges from 0001~9999 and should be filled in by examiners.

6. Years of Residence in Macao

This refers to the number of years the subjects had continuously been living in Macao. Valid information was required.

E.g.: If a subject has been living in Macao for 8 years, it would be:

0	8
---	---

7. Labor Intensity of Daily Work

This item should be filled in by university students and adults based on their current working environment. Seniors should fill in based on the actual conditions of their current or preretirement occupations. Daily work was divided into non-labor intensive and labor intensive work. Non-labor intensive work mainly refers to sedentary work, related occupations include legislative officers, public administration officers, community leaders and managers, professionals, technicians or professional assistants, and office clerks etc. Labor intensive work include light physical labor (mainly refers to work done seated with upper limb movements, or standing or walking most of the work time) and heavy physical labor (mainly refers to heavy physical activities, manual load handling or lifting, digging, etc.). Related occupations include customer service personnel, sales personnel and personnel with similar work nature, skilled agricultural and fishery workers, crafts persons and artisans, machine operators, drivers and assemblers, and non-technicians etc. Digit "1" was for non-labor intensive work, "2" for work done seated with upper limb movement, "3" for heavy physical labor. Both "2" and "3" were labor intensive work.

Subjects should fill the code in the box according to their actual occupation.

E.g.: If a subject was an office clerk engaged in sedentary work, it would be:

1

8. School Grade/Academic Year

This item was for primary, secondary and university students only. Valid information was required.

III. Questionnaire

Generally, the questionnaire was composed of single choice and multiple choice questions. Questionnaire on fitness literacy was composed of single answer multiple choice questions, multiple answer multiple choice questions, multiple-choice sorting questions and blank-filling questions.

■ Single Answer Multiple Choice Questions

Subjects should select a choice closest to their situation and put the corresponding number in the box.

E.g.: If the caregiver of a young child was a senior family member, the corresponding number for Question 19 would be 2. Fill in as:

2

If the corresponding number was a two-digit number, both digits should be filled in the same box. For instance, if the answer was (11), the box should be filled in as:

11

■ Multiple Answer Multiple Choice Questions

Subjects should select choices (up to 3 choices) closest to their situation and put the corresponding numbers in the boxes according to their precedence.

If a subject has only selected one or two choice(s), the last one or two box(es) had to be filled in with the number “0”. As a reminder, at least one choice should be selected for each multiple choice question.

E.g.: If a young child suffered from three diseases, i.e. acute bronchitis, nephritis and anemia, then the boxes would be:

1	8	14
---	---	----

E.g.: If a young child only suffered from acute bronchitis, then the boxes would be:

1	0	0
---	---	---

■ Choice Question of Fitness Literacy

When answering multiple choice questions, please circle the corresponding number with “○”. E.g. If the answer is the number 5, circle Number ⑤. If you want to change your answer, cross the original answer with a slash, e.g. “~~5~~”, and then circle the new answer with “○”. For multi-answer sorting questions, in addition to drawing a circle “○” on the corresponding number of each option, the corresponding numbers should be filled in the boxes in order of precedence. For blank-filling questions, fill in the boxes with the answers, such as “Sitting or reclining time”, fill in the boxes with “10” hours and “30” minutes.

Before filling out the questionnaire, examiners should remind subjects to read and answer the questions carefully in order to avoid errors.

1. Questionnaire for Young Children

The questionnaire for young children include three parts: personal information of young children, paternal and maternal personal information, and fitness literacy. Information of the young children could be completed by their parents.

■ Personal Information of Young Child

(1) Place of Birth

This refers to the place where the young child was born, birth certificate issued by the hospital shall prevail.

E.g.: If the young child was born in Macao, the box should be filled as:

2

(2) Parish of residence

This refers to the parish where theyoung child lives.

E.g.: If the young child lives in S. Francisco (Coloane), the box should be filled as:

1

(3) Birth weight and birth length

These should be based on the birth certificate issued by the hospital. If unsure or unable to answer, fill in the box with 99.9.

(4) Gestational age

This should be based on diagnosis by the hospital or doctor. Usually, a gestational age of 40 weeks is medically considered as a full-term (standard). Early-term refers to birth at least two weeks before term. Late-term refers to birth at least two weeks after term. Full-term birth is birth within two weeks of expectancy date.

(5) Feeding pattern within 4 months after birth

Formula feeding refers to any feedings other than breast milk (e.g. milk or milk powder). Mixed feeding refers to a combination of breast feeding and formula feeding.

(6) Any hospital-diagnosed diseases

The child's condition after birth is required, refer to Question 15 of questionnaire for types of diseases suffered.

(7) Diseases suffered

This refers to whether the child had been diagnosed with any diseases since birth. This is a multi-answer multiple choice question with at most 3 disease choices. The information filled should be valid diagnosis from hospitals. If the disease diagnosed is not listed among the choices, select "others". If the child is not suffering any diseases, select "no" and skip Question 15.

(8) Any sibling(s)

This refers to the number of brothers and sisters in the family. If the subject is an only child, choose option 1.

(9) Any congenital disease or disability that affect physical activity

This refers to any congenital diseases or disabilities that might affect the child from exercising. If the answer is no, fill in the box with "1"; if the answer is yes, fill in the box with "2" and briefly specify the disease or type of disability.

(10) Kindergarten attendance

Half-day means the child only spends half a day at kindergarten. Full-day means the child spends the day at kindergarten but goes home in the evening (except during the holidays). Boarding refers to the child living in kindergarten and returns home regularly during the weekends.

(11) The child's caregiver at home

This refers to the main person who takes care of the child at home and living with the child. The purpose is to learn whom is the most influential on the child's habits and behavior.

(12) Frequency of tooth brushing, tooth flossing and receiving dental examination

Maintaining good oral hygiene is crucial for oral health and physical health. Tooth brushing is a key part of family dental care. It is necessary to use dental floss at least once a day and have regular dental examinations in order to prevent periodontal diseases.

(13) Living with parents or not

This is to study whether the young child lives with his/her parents, and the influence the parents' living habits have on their child's daily behavior and habits.

■ Paternal and Maternal Personal Information

(1) Date of birth

Valid information was required.

(2) Place of birth

The filling requirements described in the above section of young children should apply.

(3) Years of residence in Macao

This refers to the number of years the subjects' parents have been living in Macao continuously.

(4) Height and weight

If possible, the kindergartens or examiners could provide assistance in measuring the parents' weight and height when filling the form in order to obtain accurate data.

(5) Education level

This refers to the highest education level the subjects' parents received, education level is based on graduation certificates or proof of qualification .

(6) Occupation

This refers to current occupation of the subjects' parents.

According to "Macao Occupational Classification" (1997), the explanations of each occupation were as follows:

① Legislative officers, public administration officers, community leaders or managers

In general, this refers to one who recommends, makes decision and formulates legislative or public policies and regulations in government sectors, municipal or community groups. The person also plans, directs and coordinates activities of enterprises, institutions and relevant departments. This would include legislative officers, public administration officers, community leaders, enterprise managers and small business managers (administrators). Legislative officer refers to one who makes decision, formulates, directs, advises, authorizes, modifies and abolishes government or municipal policies, laws and regulations. This would include chief executive, legislative council members, advisory council members and municipal council members.

Public administration officer refers to one who engages in the formulation of government or municipal policies, directs and monitors the interpretation and implementation of policies and laws, represents the SAR government in other countries and regions, coordinates work between various government sectors, and supervises work of others. This would include secretaries of government agencies, heads of departments or bureaus, high commissioners, secretary-generals and persons of similar nature.

Community leader refers to one who manages human resources, formulates and implements policies in political parties, chamber of commerce, labour unions and associations of professionals, industries or sports. This person represents relevant organizations and their members in the negotiation and protection of their interests and rights from legislative bodies and government. This would include heads of political organizations, chambers of commerce, and labour unions, as well as leaders of charity, community and sport organizations.

Enterprise manager refers to one who formulates policies, plans, implements and coordinates the operation

of enterprises, organizations (with ten or more staff) or departments. This would include enterprise directors, general managers, presidents, production and operation department managers and non-production and operation department managers.

Small enterprise manager (administrator) refers to one who manages a small business (with up to ten employees). He/she plans, formulates and implements policies, supervises daily work, assesses performance, negotiates with suppliers, customers and other enterprises, plans, recruits and manages human resources, and reports to the employer. This would include administrators of various industries including agriculture, forestry, fishery, construction, mining, manufacturing, wholesale, retail trading, hotel and restaurant businesses, transportation, tourism, communication, banking, other financial institutes, insurance, real estate and social services.

② Professionals

Refers to one who engages in analysis, research and the development of ideas, theories and operation methods. He/she applies his/her knowledge and makes recommendations in the fields of natural sciences (including mathematics, engineering and technologies), life sciences (including medical science), social sciences and human sciences; involves in teaching a single or multiple subjects of theory or practical classes at different educational levels, provides commercial, legal and social services; participates in arts creation; provides spiritual guidance and publishes academic papers. This would include professionals in physics, mathematics, engineering, life sciences, health, teaching staff in higher and secondary education or similar professions, as well as professionals in law, management, business, social sciences and human sciences.

③ Technicians or professional assistants

Refers to one who engages in the study and application of natural sciences (including mathematics, engineering and technological skills), life sciences (including medical science), social sciences and human science; the teaching of primary school, preschool and special education for people with physical and mental disabilities; engages in technical work in business, finance, management and social services; and provides arts and recreational sports activities. This would include technicians or assistants in physics, chemistry, engineering, life science and health science; teachers in primary schools, preschools and other majors; and technicians or assistants in management, business, social services and law.

④ Office clerks

Refers to one who engages in shorthand, typewriting, word processing, office equipment operation; data entry into computers, performs secretarial work, records and calculates data; handles the inventory, manufacturing and transportation records; handles passenger and flight records; performs management of the library, categorizes documents, provides postal services, performs accounting duties, provides travel arrangement services, provides customers with necessary resources, makes appointments, arranges meetings, and answers the telephone etc. This would include office clerks, cashiers, tellers, receptionists, ticket agents and personnel of similar nature.

⑤ Customer service, sales representatives or similar profession

Refers to one who engages in tourism, domestic services, foods and beverages, child care, beauty care, escort, astrology or fortune-telling services. Person who provides security services, works as arts or commercial models, participates in business sales or marketing, and demonstrates products to customers. This would include security officers, models, salespersons and product demonstrators.

⑥ Workers in the fishery or agricultural field

Refers to one who engages in the preparation and cultivation of agricultural lands, prepares seeds, grow plants, fruits and vegetables, applies fertilizer and harvests produce; raises livestock for meat, milk, leather; engages in catching, storing and selling of marine products and mollusks. This would include skilled workers in fishery, agriculture and animal husbandry fields.

⑦ Artisan or craftsperson

Refers to one who exploits and processes minerals; builds, maintains and repairs buildings and other structures; casts, welds and processes metals; constructs metal frameworks; builds machines, tools, equipments and other metal products; maintains and repairs craft machines; manufactures precise instruments, jewelries, household appliances, precious metal items, ceramics and glass products; manufactures handicrafts; printing; manufactures and processes foods, textile, wood, leather and other products. This would include workers in mining, construction, metal, machinery or similar nature, precision instrument, printing, handicraft, food processing, wood handling, textile, leather industries etc.

⑧ Machine operators, drivers or assemblers

Refers to one who operates, monitors and handles materials such as wood, metal, minerals, industrial machines and tools etc.; assembles specific multi-component products; operates vehicles, mobile machines and equipments. This would include operators of machines, vehicles, vessels, heavy mobile equipment and product assemblers.

⑨ Non-technicians

Refers to one who engages in mobile sales of goods; cleans private housing, hotels and offices; guards entries of apartment buildings; collects garbage; delivers mails, documents and parcels; collects coins from vending machines; manual handling of luggages; drives passengers in a rickshaw; engages in simple works related to construction, manufacturing, transportation, fishery and agriculture industries. This would include non-technicians in sales and services, fisheries and agriculture, mining, construction, manufacturing and transportation.

⑩ Others refer to other occupations not listed in the above classifications.

In addition, explanations of the following two choices are as follows:

⑪ Unemployed: refers to one who has not reached retirement age and is capable to work, but currently jobless.

⑫ Housewife/househusband: refers to an adult who has not reached retirement age and is capable to work, but presently engaged in household duties at home instead of working.

■ Fitness Literacy of Young Children

Young children's fitness literacy consist of their fitness knowledge, attitude to fitness, fitness skills acquired, fitness habits, external fitness environment, and personal social fitness. Questions were mainly about children's exercise attitude, exercises they are good at and have mastered, daily exercise duration on school days and rest days, their participation in sports-related training classes, their screen time, and nap/sleeping time. Single answer or multi-answer multiple choice questions should be completed as required according to the child's recent fitness status/exercise activities.

(1) To determine young children's preferences of activities

This is to learn whether children enjoy outdoor activities and team activities. Please choose the corresponding options according to your child's circumstances.

(2) Major physical exercises the child frequently participates in and is good at

This is to study physical exercises the child often participates in and is good at. Please choose the corresponding options according to your child's actual exercise participation.

(3) Daily exercise and sports-related training classes duration

School days refer to Mondays to Fridays, and rest days refer to Saturdays, Sundays or holidays. Daily exercise duration refers to the average cumulative time spent on physical exercise each day, including daily average time of sports related activities such as, playing outdoors, attending curricular activities, and exercising at home. Please choose the corresponding options according to children's daily situations.

(4) Average daily time children and their parents spend watching TV and using electronic devices such as mobile phones/laptop computers/tablets.

This is to determine children's total screen time, the cumulative time of TV watching and using electronic devices such as mobile phones/laptops/tablets. Please choose the corresponding options according to the daily situations of children and their parents. In addition to the screen time at home from Mondays to Fridays, the time spent by young children watching TV and video teaching in kindergartens should also be accumulated.

(5) Average duration of mid-afternoon nap/nightly sleep

It refers to children's average duration of mid-afternoon nap or nightly sleep. Please choose the corresponding options according to children's daily sleep status.

(6) Children's personal traits

It describes children's traits of character, e.g. physically active, quiet or prefers to stay alone. Each trait was measured based on five grades. Please choose the corresponding options according to children's daily situation.

(7) Evaluation of children's exercise ability, and exercise frequency of children and their parents

It objectively describes exercise ability and amount of physical exercise of children and their parents. Please choose the corresponding options according to the actual conditions.

(8) Entertainment products frequently played with or adapted to

This refers to entertainment products children often play with or use in daily life. Please choose the corresponding options according to the child's conditions.

(9) Children's weight status

It is to determine the subjective evaluation of children's weight given by their parents or caregivers. Please choose the corresponding options according to your subjective evaluation.

(10) Choosing physical exercises

It is to determine the choice making when deviations appear between parents/caregivers and children. Please choose the corresponding options according to actual handling methods.

(11) Children's play time and family rules

It is to determine the time parents/caregivers spent playing with children, and their requirements for children. Please choose the corresponding options according to the actual conditions.

(12) Understanding and attitude towards physical exercise

It is to determine your attitude towards physical exercise. Please choose the corresponding options according to the actual conditions.

(13) Community environment

It is to determine your community environment and its safety. Please choose the corresponding options according to the actual conditions.

2. Questionnaire for Children and Adolescents (Students)

Primary school students could fill out this questionnaire with the help of their parents. Secondary school and university students had to complete the questionnaire by themselves.

■ Personal Information of Children and Adolescents (Student)**(1) Place of birth and parish of residence**

The filling requirements described in the section of young children should apply.

(2) Diseases suffered

This refers to any diseases suffered within the past five years. The type of diseases should be diagnosed by a doctor and the maximum number of diseases written down should not be more than three. If disease suffered could not be found from the choices, select "others". If no diseases suffered for primary and secondary school students, select "no" and skip Question 12. For university students, if the answer is "no", skip Question 13.

(3) Frequency of tooth brushing, flossing and receiving dental examination, occurrence of dental caries

The questions are consistent with those for young children, and the same filling requirements should apply.

(4) Any sibling(s)

This question is for primary and secondary school students. Consistent with the question for young children, the same filling requirements should apply.

(5) Any congenital disease or disability that affects physical activity

This question is for primary and secondary school students. Consistent with the question for young children, the same filling requirements should apply.

(6) Living with parents or not

This question is for primary and secondary school students. Consistent with the question for young children, the same filling requirements should apply.

■ Fitness Literacy of Children and Adolescents (Primary 1~3, Primary 4~6, Junior Secondary 1~Senior Secondary 3)

Fitness literacy of children and adolescents consist of their fitness knowledge, attitude to fitness, fitness skills acquired, fitness habits, external fitness environment, and personal social fitness. Questions were mainly about their mastery of fitness knowledge, attitude to fitness, physical exercises in which they frequently participate, exercises they are good at, warm-up exercises familiar with, any exercise related injuries, situations in physical education classes, and extracurricular exercises. Single answer or multiple answers multiple choice questions should be completed as required according to recent fitness status/physical exercising situations of subjects.

(1) Fitness knowledge

This question is for primary and secondary school students. Please choose the proper option according to your understanding from the three options of “Correct”, “Incorrect” and “Don’t know”.

(2) Enjoy physical exercise activities, and put a score for his/her performance in PE classes

This is for children of Primary 1~3. Children should give a subjective evaluation for physical exercise according to their preference, and choose the corresponding options based on the actual conditions.

(3) Enjoys playing, and always feeling energetic.

This is for children of Primary 1~3. Children should provide a subjective evaluation of playing and their own vitality, and choose the corresponding options based on the actual conditions.

(4) Benefits of exercising, physical exercises ever tried, physical exercises mastered and relevant reasons

The study of benefits of exercising and reasons of relevant exercises mastered was conducted among Primary 1~3 school children. Children should choose the corresponding options based on the actual benefits or reasons. The study of physical exercises ever tried, and physical exercises mastered was conducted among primary and secondary school students, and children should choose the corresponding options based on the actual conditions.

(5) Obstacles to participation in physical exercise

This is for Primary 1~3 school children, regarding their understanding of some physical exercise they were not good at. Children should choose the corresponding options based on the actual conditions.

(6) Parents’ accompanying on outdoor activities, home entertainment products for children, family rules for children playing outside

The study is for Primary 1~3 school children. The questions are consistent with those for young children, and the same filling method should apply. Parents should answer the questions according to the opinion of the parent responsible for the decision making of the child’s physical exercise or playing.

(7) Attitude to PE class

The study is conducted among Primary 1~3 school children, including inquiries about children’s interest in the content and knowledge of PE classes, and persistence in extracurricular or after-school physical exercise. Children should choose the corresponding options based on the actual conditions.

(8) Outdoor activities or exercises

The study is conducted among Primary 1~3 school children for their participation in various outdoor activities or exercises in the past month, and the duration of each exercise. Children or parents should choose the corresponding options based on children's actual conditions.

(9) Average time spent watching TV and using electronic devices such as mobile phones/laptop computers/tablets

This question is for primary and secondary school students. Consistent with the question for young children, the same filling requirements should apply.

(10) Physical exercises in which children persisted in the previous year

This question is for primary and secondary school students, regarding physical exercises children had continuously conducted in the previous year within or outside schools. Children or parents should choose the corresponding options based on children's actual conditions.

(11) Non sports-related hobby classes or training

This question is for Primary 1~3 school children, regarding their participation in any tutoring lessons, non sports-related training classes or curricular activities within the past half a year. Children or parents should choose the corresponding options based on children's actual conditions.

(12) Situations of Physical Education classes

This question is for primary and secondary school students, regarding frequency of PE classes, average duration of each PE class and how they feel. Children or parents should choose the corresponding options based on children's actual conditions.

(13) Strength training and extracurricular/after-school physical exercise

This is for primary and secondary school students, regarding the frequency of extracurricular/after-school physical exercises, duration of each session as well as their feelings. Children or parents should choose the corresponding options based on children's actual conditions.

(14) Parents' exercising and leisure-time activities

This question is for Primary 1~3 school children. Consistent with the question for young children, the same filling requirements should apply.

(15) Surroundings

This question is for Primary 1~3 school children, regarding their living environment and its safety, and the reason why you restricted your child's activities in the surroundings. It is consistent with that for young children, and the same filling requirements should apply.

(16) Sleep patterns

This question is for primary and secondary school students, regarding their average sleep time (including naps) on school or rest days. Children should choose the corresponding options based on the actual conditions.

(17) Average daily sitting time

This question was for primary and secondary school students, their average sitting or reclining time (accurate to the minute) per day, and should be filled based on the actual conditions.

(18) Children's traits

This question is for Primary 1~3 school children. Consistent with the question for young children, the same filling requirements should apply.

(19) Children's physical exercise volume and parents' physical exercising situations

This question is for Primary 1~3 school children regarding their physical exercise volume, parents' exercise frequency and their spending situation of children's participation in exercise activities. Consistent to the question for young children, the same filling requirements should apply.

(20) Presence of obesity among parents

This is for Primary 1~3 school children, regarding the parent's subjective judgment of father/mother's weight. Please choose the corresponding options based on the actual conditions.

(21) Familiar with warm-up exercises, the correct handling of exercise injuries and knee wounds

This question is for Primary 4~6 and Junior Secondary 1~Senior Secondary 3 school students, regarding whether they are familiar with warm-up exercises, the correct handling methods of exercise injuries and knee wounds. Please choose the corresponding options based on the actual conditions.

(22) Methods to access relatively scientific and professional sports and fitness information

This is for students of Junior Secondary 1~Senior Secondary 3. Please choose the corresponding options based on methods you are aware of.

(23) Reasons for choosing specific exercises, reason for persisting in the exercises chosen, and the duration of persistent exercising

This is for students of Primary 4~6 and Junior Secondary 1~Senior Secondary 3. Please choose the corresponding options based on the reason for choosing the physical exercises, the reason for persisting in the exercises chosen, and the duration of persistent exercising in the past one year.

(24) Attitude to fitness

This is for students of Primary 4~6 and Junior Secondary 1~Senior Secondary 3, regarding their attitude to physical exercise as well as personal reasons and obstacles for participation in physical exercise. Please choose the corresponding options based on the actual conditions.

■ Fitness Literacy of Children and Adolescents (University Students)

Relevant questions are consistent with those in fitness literacy of adults and seniors.

3. Questionnaire for Adults and Seniors

Questionnaires for adults and seniors should be completed by subjects themselves on-site. Subjects are encouraged to ask the examiners when in doubt.

■ Personal Information of Adults and Seniors

(1) Place of birth

This question is consistent with that for young children's parents, and the same filling requirements should apply.

(2) Parish of residence

This question is consistent with that for young children, and the same filling requirements should apply.

(3) Education level and occupation

This question is consistent with that for young children's parents, and the same filling requirements should apply.

(4) Diseases suffered

The same filling requirements of similar questions for students should apply. It is noted that the types of diseases should be filled based on diagnosis of the hospital.

(5) Perception of "Physical Fitness Study"

The Physical Fitness Study is the process of testing, evaluation and providing fitness coaching advice based on the National Physical Fitness Standards. Subjects should answer honestly based on their level of perception of this study.

■ Fitness Literacy of Adults and Seniors

Fitness literacy of adults and seniors consist of their fitness knowledge, attitude to fitness, fitness skills acquired, fitness habits, external fitness environment, and personal social fitness. Questions were mainly about their mastery of fitness knowledge, attitude to fitness, physical exercises they participate in, exercises mastered, knowledge of warm-up exercises and warm-up exercises mastered, and exercising habits. Single answer or multiple answers multiple choice questions should be completed as required according to recent fitness status/ exercising situations of subjects.

(1) Knowledge of physical exercise, and cognition of physical fitness

This is similar to the questionnaire for students, and the same filling requirements should apply.

(2) Major physical exercises participating in, exercises mastered and warm-up exercises

This is similar to the questionnaire for students (Primary 4~Senior Secondary 3), and the same filling requirements should apply.

(3) Fitness plan scheduling and persistent exercising

Subjects should choose the corresponding options based on the actual conditions of fitness plan.

(4) Main reasons and obstacles for participation in physical exercise

Subjects should choose the corresponding options based on the actual conditions.

(5) Work status

Subjects should fill in the working hours per week according to the current professional activities, including volunteering work but not including house chores as housewives/husbands

(6) Labor intensity at work per week

Subjects should fill in the number on days per week in which subjects engage in vigorous activities and moderate-intensity activities that last for more than 10 minutes, and the daily cumulative time of activities at such intensities. The cumulative time is based on usual conditions of accumulated time, which is usually a multiple of 10.

(7) Average daily sitting or reclining time

This is consistent with the questionnaire for students, and the same filling requirements should apply.

(8) Average sleep time (including naps)

It refers to the average duration of sleep, accurate to the minute. Subjects should fill in based on the actual conditions.

(9) Major means of transportation for commuting, and the cumulative time of walking or bicycling for at least 10 minutes per week

Commuting refers to the travelling to work, shopping and attending gatherings, but does not include walking or bicycling with the purpose of training or exercising. Subjects should fill in based on the actual means of transportation for commuting, the days per week of walking or bicycling for at least 10 minutes, and the daily cumulative time of walking or bicycling. The cumulative time is based on usual conditions of accumulated time and is usually a multiple of 10.

(10) Labor intensity of house chores per week

Subjects should fill in based on the number of days per week in which subjects conduct vigorous and moderate-intensity house chores for at least 10 minutes, and the daily cumulative time of conducting house chores at such intensities. The cumulative time is based on usual conditions of accumulated time and is usually a multiple of 10.

(11) Leisure-time activities, exercise frequency, duration and intensity

Leisure-time activities are similar to those in the questionnaire for parents of Primary1~3 school students, and the same filling requirements should apply. However, the answers here had to be sorted in order of precedence while students do not need to. The questions on exercise frequency, duration and self-perception of each session are similar to those in the questionnaire for students, and the same filling requirements should apply.

(12) Exercise intensities of each week's exercise training

Subjects should fill in based on the days per week in which subjects engage in high-intensity and moderate-intensity exercises for at least 10 minutes, frequencies per day and the daily cumulative time of

exercising at such intensities. The cumulative time is based on the usual conditions of accumulated time, and is usually a multiple of 10.

(13) Duration of persistent exercising and conditions of strength training

For duration of persistent exercising, it is consistent with the questionnaire for students of Primary 4~6 and Junior Secondary 1~Senior Secondary 3. For strength training, it is consistent with the questionnaire for primary and secondary students. The same filling requirements should apply.

IV. Examined Indicators

1. When examiners record the examination values into the respective boxes, each box is for one Arabic number only. If examination and recording were conducted by two different people, the recording staff should loudly repeat the reported value. For example, when the examiner reported the value 168.5, the recorder should repeat 168.5 loudly in order to ensure accuracy.

2. When recording results, all boxes before and after the decimal point should be filled. If the result is a whole number, the boxes after the decimal point should be filled with the values "0". If there are three boxes before the decimal point, and the recorded value is two-digits, the first box should be filled with the value "0".

For instance: A subject's height is 168.5cm and the weight is 59.0kg, the boxes should be filled in as follows:

Height	1	6	8	·	5	(cm)
Weight	0	5	9	·	0	(kg)

3. For sit and reach, the first box should be filled as "+" or "-", which represents a positive or negative value, do not fill in any Arabic numbers. Tested values should be filled starting from the second box.

4. For walking on the balance beam, if the young child succeeds in moving forward by alternating the legs on the beam, "1" should be put into the box. If the young child manages to complete moving sideways on the beam, "2" should be filled into the box. If the young child fails to complete in either ways, "3" should be filled into the box.

5. If the young child fails to conduct successive jumps with both feet, "99.9" should be filled into the box.

6. For 50m × 8 shuttle run, 800m run or 1000m run, results should be recorded in units based on minutes and second, then converted into seconds and filled into the boxes..

Appendix 3: Methods of Examining the Indicators of 2020 Physical Fitness Study of Macao SAR Residents

“Skeletons of the whole body and the main bony landmarks” (Figure 1) was used as reference for locating examination points.

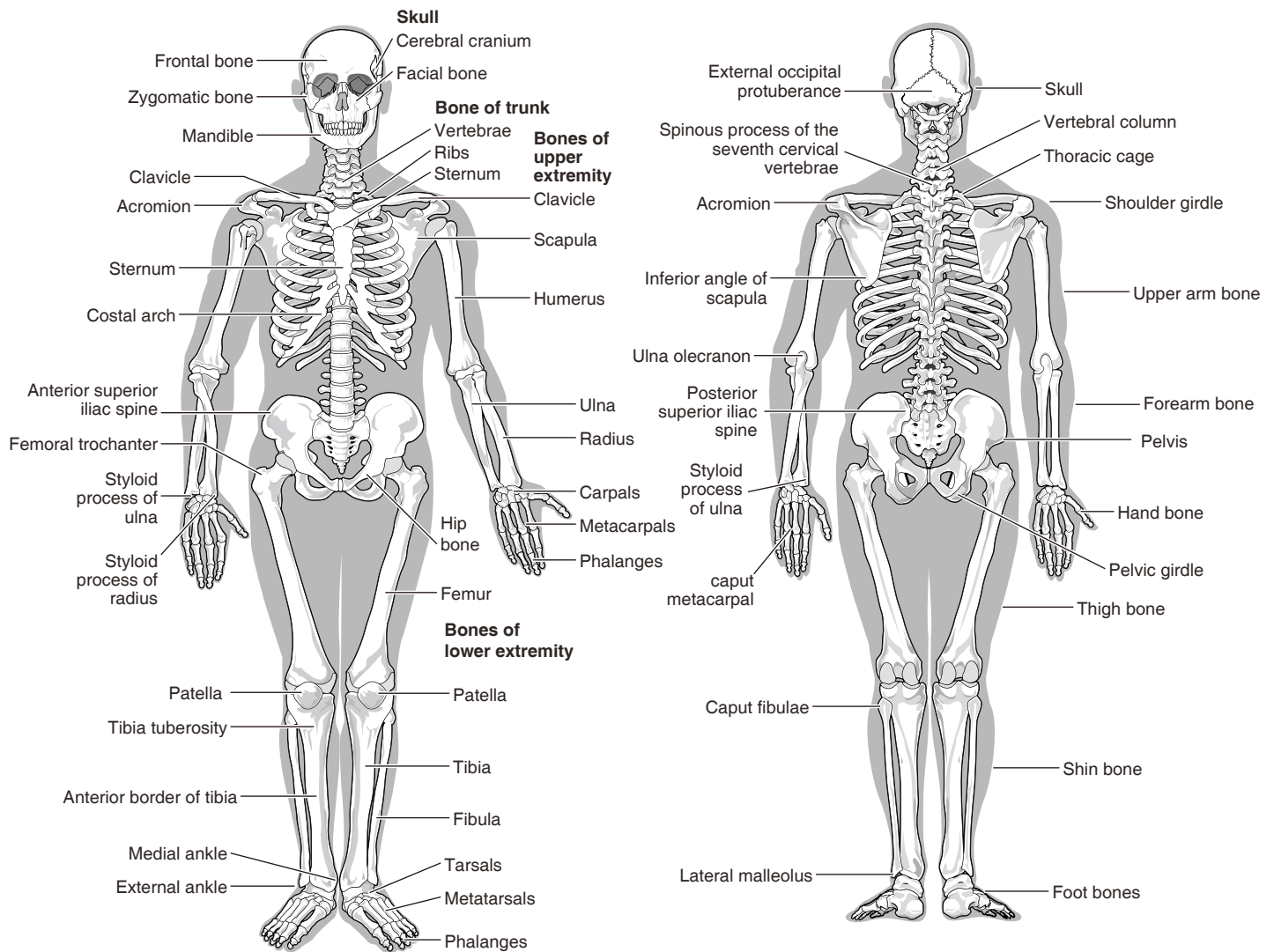

Figure 1 Skeleton of the Whole Body and the Main Bony Landmarks

I. Anthropometric Indicators

1. Height

Apparatus: Stadiometer

Testing Method: On bare feet, the examinee should stand upright against the stadiometer, eyes looking straight (with upper part of tragus of the ears and lowest part of the eyes align horizontally). Upper limbs should be naturally down and both legs straight. The two heels should be kept together allowing the toes to be 60° apart. Three points namely the heels, the sacrum area and between the shoulder blades of the examinee should be in contact with the vertical board, forming a standing posture of “three points into one line” (Figure 2). The examiner then slides the horizontal bar down onto the examinee’s head. When reading the scale, the eyes of the examiner should be leveled with the horizontal bar. Measurements are recorded in centimeters, rounded to one decimal place.

Note:

- ① The stadiometer should be placed on a flat surface, against the wall.
- ② The examiner should hold onto the handle of the horizontal bar when moving it.
- ③ The “three points against the scale” and “two points horizontal” should be strictly adhered to.
- ④ The tightness of the horizontal bar should be adjusted suitably when placing it onto the examiner’s head. If an examinee has frizzy hair, the hair should be pushed down when sliding the horizontal bar. Any braids or hair knots that affect measurements should be untied, and accessories should be taken off.
- ⑤ When reading was completed, the horizontal bar should be gently slid up to a safe height immediately to prevent damages.



Figure 2 Height

2. Sitting Height

Apparatus: Mechanical stadiometer

Testing Method: The examinee should be seated with the trunk sacrum and shoulder blades touching the vertical board. The body and head should keep straight and look horizontally to the front. The upper part of the tragus of the ear and lower part of the eye should form a horizontal line. Upper limbs should be naturally down and do not press the seating plate with the hands. The legs are kept together, feet flat on the ground, thighs parallel to the ground and perpendicular with the shanks (the stepping box should be adjusted to proper height based on the length of the examinee’s shanks) (Figure 3). The examiner should stand on the right side of the examinee and slide the horizontal bar onto the examinee’s head. Recording should be done with the examiner’s eyes on the same level as the horizontal bar. Measurements are recorded in centimeters and rounded to one decimal place.

Note:

- ① To guarantee proper positioning, the examinee should first bend forward before sitting to ensure the sacrum touches against the vertical board.
- ② Young children that are shorter should place their feet on a stepping box of suitable height in order to prevent them from slipping forward during examination.
- ③ Other important points are the same as above.



Figure 3 Sitting height

3. Weight

Apparatus: Electronic digital scale

Testing Method: The examiner switches on the scale by pressing the on/off button, and a flickering signal would appear on the screen. The scale is ready when the screen shows “0.0”. The examinee should wear short shorts and shirts, bare foot and stand at the center of the scale, ensure the body is maintained steady (Figure 4). The examiner can record the displayed value when the screen stops flickering. Recording is done using kilograms as the measuring unit and rounded to one decimal place.

Note:

- ① During measurement, the scale should be placed on a flat surface.
- ② The examinee should minimize clothing as much as possible.
- ③ The examinee should step on and off the scale slowly and gently.



Figure 4 Weight

4. Chest Circumference

Apparatus: Measuring tape

Testing Method: The examinee should stand straight, shoulders relaxed with both arms down naturally. Feet should be kept shoulder width apart and maintain steady breathing. The examiner should stand facing the examinee, then wrap the tip of the measuring tape through from the examinee’s inferior angle of the scapula around to the chest. For males and pre-puberty females, the lower part of the tape should be placed on the nipples (Figure 5). For females after puberty, the tape should be placed on top of the nipples, parallel to the fourth rib. The tape should be at a suitable tightness (without obvious indentation mark onto the skin). The value that meets the “0” point of the tape is recorded. The value should be read when the examinee exhales. Recording is done using centimeters as the measuring unit and rounded to one decimal place.

Note:

- ① During measurement, the examiner should pay attention to the standing posture of the examinee. Lowered head, shoulders shrugged, chest out or hunchback should be corrected promptly.
- ② The examiner should strictly control the tightness of the measuring tape.
- ③ If the scapula was difficult to find, get the examinee to flex his/her chest. When the scapula can be clearly identified, the examinee should switch back to the right posture for measuring.
- ④ If the two sides of the scapula are not of the same height, the lower side should be used for measurement.



Figure 5 Chest circumference

5. Waist Circumference

Apparatus: Measuring tape

Testing Method: The examinee should stand straight and shoulders relaxed with both arms crossed over the chest. The examiner should stand facing the examinee and wrap the tape 0.5~1cm above the belly button around the examinee (the thickest part of the waist should be measured for overweight examinees) (Figure 6). The examiner should keep the tape at a suitable tightness (without obvious indentation mark on the skin). The value that meets the “0” point of the tape is recorded. Recording is done using centimeters as the measuring unit and rounded to one decimal place.

Note:

- ① The examiner should strictly control the tightness of the tape.
- ② During examination, the waist of the examinee should be fully exposed.
- ③ During examination, the examinee should not intentionally tighten or loosen the abdominal part.



Figure 6 Waist circumference

6. Hip Circumference

Apparatus: Measuring tape

Testing Method: The examinee should stand straight and shoulders relaxed with arms crossed at the chest. The examiner should face the examinee diagonally and wrap the tape around the most prominent part of the examinee's gluteus maximums (Figure 7). The examiner should keep the tape at a suitable tightness (without obvious indentation mark on the skin). The value that meets the “0” point of the tape is recorded. Recording is done using centimeters as the measuring unit and rounded to one decimal place.

Note:

- ① The examiner should strictly control the tightness of the tape.
- ② During examination, males should only wear shorts and females should wear shorts, tank tops or short sleeve shirts.
- ③ During examination, the examinee should not intentionally tighten or loosen the abdominal part.



Figure 7 Hip circumference

7. Body Fat Percentage

Apparatus: Body fat monitor

Testing Method: The examiner should input basic information of the examinee such as height and weight accordingly, then confirm that the monitor is ready. When testing, the examinee should empty the bladder, take off the shoes and socks, stand relaxed on the foot electrodes of the test platform, with muscles relaxed, and the body weight averagely distributed across both legs. The examinee then holds the electrodes with both palms, with the thumbs and palms in contact with the electrodes (during testing, saline could be applied to the soles of the feet and the sides of the palms to enhance conductivity of the skin), then extend the arms apart from the trunk by about 15° (Figure 8). After turning on the switch of the monitor, the examinee should maintain a quiet posture till the end of testing. The percentile value of body fat percentage should be recorded, rounded to one decimal place.

Note:

- ① The examinee should take off the shoes, socks and jackets, and remove metal accessories.
- ② The examinee should not eat, drink water or shower within 2 hours before measurement, and do not conduct strenuous exercises.
- ③ Drinking alcohol is not allowed within 2 days before measurement.
- ④ Using diuretics is not allowed within 1 week before measurement.
- ⑤ The skin of the test area should be cleaned with ethanol or saline solution before measurement.
- ⑥ The examinee should maintain quiet when standing, and extend both arms from the body during measurement.



Figure 8 Body fat percentage

8. Shoulder Width

Apparatus: Bare L-square

Testing Method: The examinee should stand straight, shoulders relaxed and legs kept shoulder width apart. The examiner should stand behind the examinee and find the most convex part or peak point of the shoulders by feeling along the scapular area using the index fingers of both hands. The distance between the two peak points of the shoulder is measured with the bare L-square (Figure 9). Recording is done using centimeters as the measuring unit and rounded to one decimal place.

Note:

- ① The examinee should relax both shoulders naturally, avoid shrugging or being nervous.
- ② The examiner should find the peak points precisely first and then adjust the bare L-square.



Figure 9 Shoulder width

9. Pelvis Width

Apparatus: Bare L-square

Testing Method: The examinee should stand straight with both shoulders relaxed and legs shoulder width apart. The examiner should be facing the examinee diagonally and find the ilium point, which is the widest part of the hip by using the index fingers of both hands. The distance between the two iliac crests is measured using the bare L-square (Figure 10). Recording is done using centimeters as the measuring unit and rounded to one decimal place.

Note:

- ① The examinee should not bend over, bend the legs or twist the trunk.
- ② The examiner should first find the ilium point, first and then adjust the bare L-square.



Figure 10 Pelvis width

10. Foot Length

Apparatus: Foot length ruler

Testing Method: The examinee should stand straight with bare right foot on the ruler. The heel should be against the fixed board, the sole of the foot pressed onto the plate and the outer part of foot closest to the side board of the ruler. The examiner should move the slipping board to the tip of the toe and measure the maximum length from heel to toe (Figure 11). Recording is done using centimeters as the measuring unit and rounded to one decimal place.

Note:

- ① During measurement, the examinee should not bend the toes.
- ② The length of the foot should be parallel to the ruler.



Figure 11 Foot length

II. Physiological Function Indicators

1. Resting Pulse (Heart Rate)

Apparatus: Stopwatch and medical stethoscope

Testing Method: The examinee should be seated with the right forearm placed on the table and the palm facing up. The examiner should sit at the right side of the examinee and measure the pulse of the examinee by pressing the tips of the index finger, middle finger and ring finger on the radial artery of the wrist. For young children, the examinee should be examined lying down and the heart rate be measured with a stethoscope by placing it on the precordial area (the intersecting point of the left collar bone and the fifth rib bone) (Figure 12).

Before measurement, the examiner should make sure that the examinee is in a calm state (That is, using 10 seconds as a unit, measure the pulse for three consecutive 10 seconds. If two of the measured units are the same and the difference with the third unit is less than one heart beat, the examinee is in a calm state; otherwise, the examinee should rest until he/she meets the requirement). Then, measure the pulse for 30 seconds and double the figure to get the result. Measuring unit is the number of heart beats.

Measurement of heart rate is the same as that of the pulse.

Note:

- ① The examinee should avoid strenuous exercise one to two hours before measurement.
- ② Adult and senior examinees should sit calmly for 10 minutes or more before measurement.
- ③ Measurement for young children could take place after their afternoon nap.



Figure 12 Resting pulse (Heart rate)

2. Blood Pressure

Apparatus: Sphygmomanometer and medical stethoscope

Testing Method: The examinee should be seated with the right arm naturally placed on the desk with palm faced up. The “0” point of the sphygmomanometer should be leveled with the heart and right arm of the examinee. The examiner should ensure the inflation cuff is at a suitable tightness, and the elbow adequately exposed. After locating the brachial artery, place the stethoscope head in full contact with the skin, but do not press tightly or tuck under the cuff. Inflate the cuff to raise the mercury column quickly until the arterial pulse is no longer heard, then further raise the mercury column by 20 to 30 mmHg. After that, the examiner should slowly release the air until the first pulse beat is clearly heard. This point is the systolic pressure. The examiner should release the air further until the pulses fade away. This point is the diastolic pressure (Figure 13). Blood pressure should be measured in one trial; otherwise, a re-examination is needed. The recording of systolic pressure and diastolic pressure uses mmHg as the measuring unit.



Figure 13 Blood pressure

Note:

- ① The examinee should avoid strenuous exercise one to two hours before measurement.
- ② The examinee should sit for about 10 to 15 minutes to calm down before measurement.
- ③ The examiner should check whether the mercury is at “0” point initially before examination. If not, the examiner should adjust it. The examiner should also check whether there are bubbles in the mercury column and remove them if any. During examination, the sleeves of the shirt should not be tightly wrapped around the upper arm.
- ④ The bottom of the inflation cuff should be 2.5cm above the elbow.
- ⑤ If a re-examination is needed, the examiner should wait until the mercury column drops back down to “0”.
- ⑥ If a re-examination is needed, the examinee should further rest for 10 to 15 minutes before beginning the re-examination. Professionals on site should be notified to pay attention to examinees with high blood pressure readings.

3. Vital Capacity

Apparatus: Electronic spirometer

Testing Method: The examiner turns on the switch and presses the button of the spirometer. A flickering “8888” signal would show on the screen and when it stops at “0”, the spirometer is ready.

The examiner should first put the disposable mouthpiece in the air inlet and give it to the examinee. The examinee should hold on to the handle of the tube and inhale deeply until unable to inhale more air with head leaning back slightly. Then, the examinee should place the mouthpiece to the mouth and exhale slowly into the mouthpiece (Figure 14). The value shown on the screen is the vital capacity measurement. The examination should be done twice and the examiner should record the largest value using milliliter as the measuring unit, rounded to the nearest whole number.



Figure 14 Vital capacity

Note:

- ① During testing, a disposable mouthpiece should be used. If a mouthpiece has to be reused, it must be strictly desanitized.
- ② Before testing, the examiner should explain and demonstrate the methods. The examinee could also try to blow once.
- ③ During testing, the examinee should not exhale too forcefully to prevent air leaking from the mouthpiece. Also, the soft tube must be maintained on top of the inlet.
- ④ No inhaling is allowed once the examinee started exhaling into the spirometer.
- ⑤ The examiner should also correct the examinee if he/she exhales through the nose. The examiner could ask the examinee to put on a nose clip or pinch the nose to prevent exhaling through the nose.
- ⑥ Before the next testing, the examiner should press the button to restore the spirometer to “0”.

4. Step Test

Apparatus: Several Step boxes (Step box height for males: 30cm; Step box height for females: 25cm), heart rate monitor, stopwatch (back up).

Testing Method: The examinee should stand in front of the step box and be prepared for the test. The examiner turns on the heart rate monitor. When the flickering signal appears on the screen, presses the button and the monitor is ready. After three loud preparation beeps from the monitor, the examinee should start stepping up and down the step box according to the rhyme of the monitor.

The examinee should step up with one foot on the first beep, and up with the other foot on the second beep; both legs should be straight when standing on the step. The examinee then stepped down with the first foot on the third beep followed by the other foot on the fourth beep. This would continue for 3 minutes (Figure 15). A long beep signifies the end and the examinee should be seated with the forearm placed forward, palm facing up and fingers naturally apart and curved. The examiner then clips the finger sensor onto the tip of the examinee's index or middle finger.

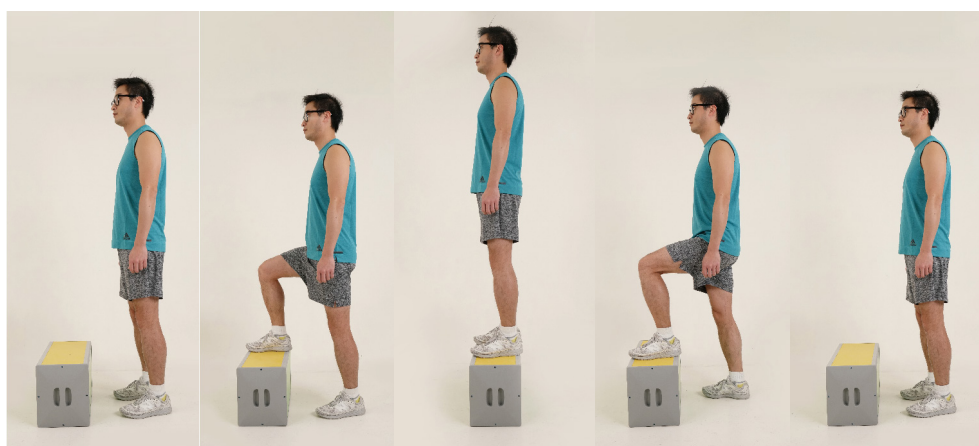

Figure 15 Step test

The heart rate monitor examines the post-exercise pulse for three times. After testing, the examiner should press the “function” button and record the exercise duration, 30-second pulse after one minute, two minutes and three minutes post-exercise.

During testing, if the examinee could not complete the exercise or could not step up and down the step box according to the beat for three consecutive times, the examiner should stop the examinee from continuing. Then simultaneously press the “function” button, put on the finger sensor and begin the pulse recording procedures.

Note:

- ① Examinees with heart malfunction or heart diseases should not participate in this testing.
- ② Examinees should avoid any vigorous exercise before testing.
- ③ When completely standing on the step box, the legs should be straight and knees should not be bent.
- ④ The examinee should step up and down according to the beats of the monitor.
- ⑤ The examiner should also measure the pulse of the examinee by pressing the fingers on the radial artery at the same time to compare with that of the monitor. If a difference of 2 beats within 10 beats is detected, the monitor would be considered inaccurate and manual measuring should be used instead.
- ⑥ Manual pulse measuring method: measure the post-exercise pulse at three intervals – from one to one and a half minute, two to two and a half minute and three to three and a half minute after exercise.

5. Submaximal Bicycle Ergometer Exercise Test

Apparatus: Bicycle ergometer, telemetry heart rate meter, stopwatch (back up), and RPE scale

Testing Method: The examiner should confirm that the bicycle ergometer is ready. Before testing, the examiner should conduct a pre-exercise risk screening of the examinee using the PAR-Q questionnaire and functional indicators. The examinee who passes the screening should wear a heart rate monitor at the inner midpoint of the right upper arm, with the light in contact with the skin to ensure successful data receiving. The height of the bicycle seat and handlebars should be adjusted according to the actual condition of the examinee to ensure he/she could pedal in the most comfortable state.

During testing, the examiner inputs the examinee's personal data and then taps "Start Test" on the host computer. The examinee sits on the bicycle for a 30~60 seconds static heart rate test. Afterwards, the examiner clicks the red button on the bicycle, and the examinee pedals the bicycle to the rhyme of 60 rpm under the set load, and maintains the same speed until the end of the test. Test duration is 7 minutes in total which includes a 30 seconds warm up, maximal load for 3 minutes, submaximal load for 3 minutes, and recovery for 30 seconds. The examiner should always pay attention to the physical condition of the examinee when pedaling, and ask the examinee to continue to do recovery activities such as walking after pedaling. The maximal oxygen consumption value, absolute value and other test data would be automatically transferred and saved to the host computer. Maximal oxygen consumption is recorded in millimeter/kg/min, rounded to one decimal place. Absolute value is recorded in liter/min, rounded to two decimal places.

Note:

- ① Anyone with cardiac dysfunction, cardiac diseases, or did not past the pre-exercise risk screening is not allowed to participate in this test.
- ② The examinee should avoid strenuous exercise, eat a light diet and have good rest one day before the test.
- ③ The examinee should always be reminded to maintain the rotation speed, and pedal continuously as per the rhythm during the whole exercise.
- ④ During the test, the examiner should always pay attention to the changes of heart rate of the examinee, and in case of continuous reception of abnormal heart rate data, stop the test promptly and decide whether to resume the test according to the recovery of the examinee.
- ⑤ The test should be terminated if the examinee has the following symptoms: chest pain, dyspnea, nausea, cyanosis, pallor, headache, etc.; heart rate not increasing with the increasing exercise intensity; or extreme fatigue reported or displayed by the examinee. Resumption of the test should be dependent on the recovery of the examinee.
- ⑥ Before the test, the examinee should have his/her height and weight measured , otherwise the complete results could not be obtained.
- ⑦ After finishing pedaling, the examinee could conduct active recovery activities such as walking.

6. Two-minute High-knee Running in Place

Apparatus: Stopwatch, adhesive tape, measuring tape or 1m long string

Testing Method: The examinee stands against the wall, and the examiner uses a tape to mark the midpoint of the iliac crest and patella (the examiner pulls a string from the middle of patella and iliac crest, and folds the string over to mark the midpoint) as the height at which the examinee steps. When the examinee hears the start signal, the examinee should start to step (not forward), and during stepping, raise both knees to the marked height on the wall (Figure 16), and the examiner would record the number of completed steps within 2 minutes (only the number of times the right knee reaches the targeted height). Recording is done using times as the measuring unit and rounded to integer.

Note:

- ① During testing, the examinee should be reminded to be aware of safety.
- ② The leg lifted should be at a height where the thigh is parallel to the ground, times unable to reach such height are not counted as valid.
- ③ The examinee should not bend down the body or bend the supporting leg.
- ④ When the examinee consecutively only lifted one leg, the test should be stopped, and resumed after the examinee takes a break.
- ⑤ If the examinee feels dizzy or experiences other physical discomforts, the test should be stopped.



Figure 16 Two-minute high-knee running in place

III. Physical Fitness Indicators

1. 10m Shuttle Run (Young Children)

Apparatus: Several 10m straight lines each 1.22 meters apart should be drawn on a flat ground (not limited to any type of ground) to lay out the lanes. One end is the starting/finishing line, and the other end is turning line. Place a target line three meters from the starting/finishing line and an object at the turning line (wooden box or wall) (Figure 17). Stopwatches are needed.

Testing Method: At least two examinees are needed to perform this test. They should stand at the starting line with one leg forward and one leg back. Upon hearing the starting signal, the examinees should run immediately towards the turning line, touches the object (wooden box or wall) and then turn back towards the target line (Figure 18). The starter should stand on the side and at the front of the starting line to give signals, start the stopwatch as soon as the examinees begin to run, and stop the stopwatch when the examinee's chest passes through the finishing line. This test would only be done once. Record the time used from start to finish using seconds as the measuring unit, rounded to one decimal place. The number at the second decimal place is rounded up if it is not "0".

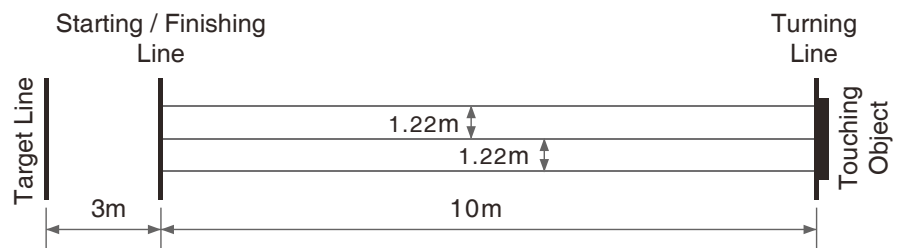

Figure 17 Diagram of 10m shuttle run track



Figure 18 10m shuttle run

Note:

- ① Before testing, the examiner should explain clearly that the examinee has to run in a straight line at full speed and not run into other lanes on the track.
- ② Before starting to run, the examinee should not step on or cross the starting line.
- ③ When starting, if the examinee fails to hear the starting signal, the examiner could softly push the examinee to signal that he/she could start to run.
- ④ The examinee should only slow down after passing through the starting/finishing line.
- ⑤ At the target line, a specific person should be appointed to protect the examinees from falling down.

2. 50m Run (Students)

Apparatus: Several 50m long lines each 1.22 meters apart should be drawn on a flat ground (not limited to any types of ground) to lay out the lanes. One end is the starting line and the other end is the finishing line (Figure 19). A signaling flag, a whistle and several stopwatches are needed.

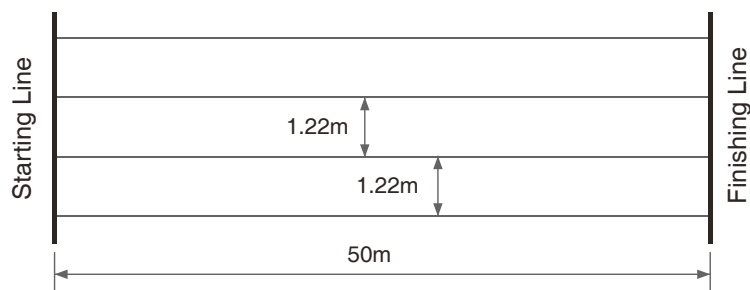

Figure 19 Diagram of 50m run track

Testing Method: At least two examinees are needed to perform this test. They should wait at the starting line and upon hearing the starting signal, the examinees begin to run towards the finishing line at full speed. The starter should stand on the side and at the front of the starting line, wave the flag while blowing the whistle. The timer at the side of the finishing line starts timing once the flag is waved (Figure 20). Recording is done using seconds as the measuring unit and rounded to one decimal place. The number at the second decimal place is rounded up if it is not "0".



Figure 20 50m run

Note:

- ① Before testing, the examiner should explain clearly that the examinee has to run in a straight line at full speed towards the finishing line and not into other lanes on the track.
- ② Before starting to run, the examinee should not step on or cross the starting line. If any examinee begins to run before the starting signal, the examiner should recall the examinee and restart the run.
- ③ During testing, the examinee should wear sneakers or rubber shoes but not spiked shoes.
- ④ If it is a windy day, the examinee should run in the same direction as the wind.

3. 50m x 8 Shuttle Run (Students)

Apparatus: Several 50m long lines each 1.22 meters apart should be drawn on a flat ground (not limited to any types of ground) to lay out the lanes. One end is the starting/finishing line and the other end is the turning line. Place a target line three meters away from the starting/finishing line, and a 1.2 meters high station pole within the middle of each lane about 0.5 meter away both from the starting/finishing line and the turning line (Figure 21). A signaling flag, a whistle and several stopwatches are needed.

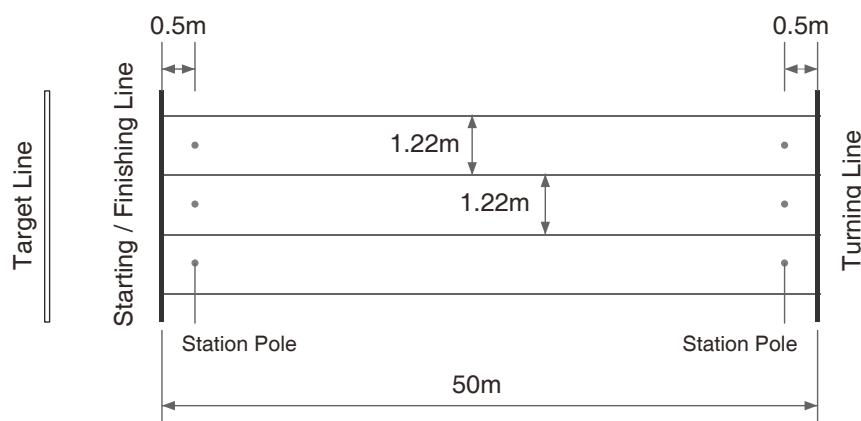

Figure 21 Diagram of 50m x 8 shuttle run track

Testing Method: At least two examinees are needed to perform this test. They should wait at the starting line and upon hearing the starting signal, the examinees begin to run towards the turning line at full speed. The examinee has to run around the station pole in an anti-clockwise direction upon reaching the turning line, then back to the starting/finishing line and run around the station pole in an anti-clockwise direction for the turning line again. This is considered one complete round and a total of four rounds is conducted. When returning, the examinee should not touch the station poles or use the poles for balance. The starter should stand at the side of the starting/finishing line, begin to time as soon as the examinees start to run and stop the stopwatch when the examinee's chest crosses the finishing line at the last round (Figure 22). This test should only be done once. The time used to finish the run is recorded using seconds as the measuring unit and rounded to one decimal place. The number at the second decimal place is rounded up if it is not "0".



Figure 22 50m x 8 shuttle run

Note:

- ① Before testing, the examiner should explain clearly that the examinee should not run into other lanes on the track.
- ② Before starting to run, the examinee should not step on or cross the starting line. If any examinee begins to run before the starting signal, the examiner should recall the examinee and restart the run.
- ③ During testing, the examiner should report the number of rounds left to the examinee in time to prevent any miscalculation.
- ④ During testing, the examinee should wear sneakers or rubber shoes but not spiked shoes.
- ⑤ The examinee could only slow down after passing the starting/finishing line.

4. 800m Run (Females) or 1000m Run (Males)

Apparatus: flat running tracks, a signaling flag, a whistle, several stopwatches

Testing Method: At least two examinees are needed to perform this test. They should wait at the starting line and upon hearing the starting signal, the examinees begin to run towards the finishing line at full speed. The starter should stand at the side of the starting line, and wave the starting flag while blowing the whistle at the same time. The timer should stand by the side of the finishing line and begin to time when the flag is waved. The timer should stop timing the timer when the examinee's chest crosses the finishing line and completed the whole distance (Figure 23). The test is only done once. Record the time needed to complete using seconds as the measuring unit, rounded to one decimal place. The number at the second decimal place is rounded up if it is not "0".



Figure 23 800m or 1000m run

Note:

Same as 50m x 8 shuttle run.

5. Standing Long Jump

Apparatus: Electronic standing long jump mat

Testing Method: The examiner turns on the switch and presses the button of the device, a flickering signal would show on the screen. When the examinee stands at the starting line, the value on the screen should be "0", which means the apparatus is ready.

The examinee selects the starting line based on their capability and stands in front of the line with both legs naturally apart, then swing both arms and jump forward with full strength (Figure 24). Three seconds after landing, the tested value would appear on the screen. The test is conducted twice and the higher score is recorded using centimeter as the measuring unit, rounded to the nearest whole number.

Note:

- ① Before starting to jump, the examinee should not step on or cross the starting line.
- ② The score is invalid in case of foul play and the examinee has to jump again until getting a valid score.
- ③ When jumping, the examinee could not bounce multiple times at the same spot, run up and make consecutive jumps etc.
- ④ Before each test, the value shown on the screen must be "0" or else the button should be pressed to reset to "0".



Figure 24 Standing long jump

6. Tennis Ball Distance Throw (Young Children)

Apparatus: Draw a rectangle 20 meters long and 6 meter wide on a flat ground. Set one end of the rectangle as the throwing line and draw horizontal lines from the throwing line at 0.5 meter intervals (Figure 25). A measuring tape and several standardized tennis balls are needed.

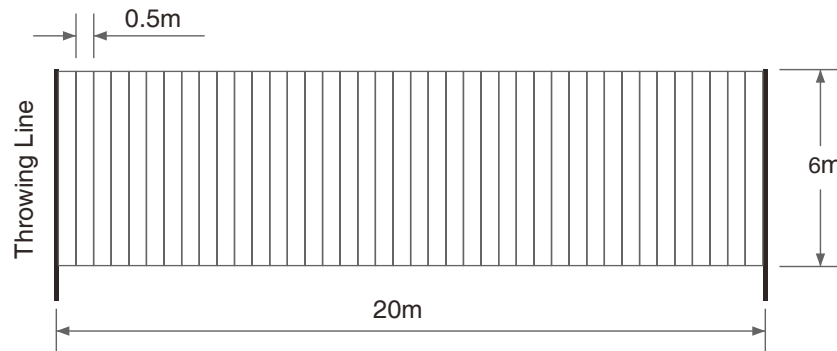

Figure 25 Diagram of tennis ball distance throw field

Testing Method: The examinee should stand behind the throwing line, legs apart, and a tennis ball in one hand. The ball is thrown from behind the shoulder. When throwing the ball, the hind leg could move forward a step but could not step on or cross the throwing line (Figure 26). An examiner would stand on the side and at the front of the throwing line to give signals. Another examiner would observe the landing point of the ball and record the distance. The test is done twice and the higher score is recorded using meters as the measuring unit, rounded to one decimal place.

Recording method: If the ball lands on a line, the value of the recording line is recorded. If the ball lands between two lines, then the value of the recording line closer to the throwing line is recorded. If the ball lands beyond 20 meters, the examiner should measure the actual distance with a measuring tape. If the ball lands beyond 6 meters wide, the examinee has to throw again.

Note:

- ① During testing, the examiner should watch the landing point of the ball closely.
- ② The examinee should not step on or cross the throwing line when throwing the ball. Run and throw method is not allowed.



Figure 26 Tennis ball distance throw

7. Walking on Balance Beam (Young Children)

Apparatus: A 30 centimeters high, 10 centimeters wide and 3 meters long balance beam is used. One end of the beam is the starting line and the other end is the finishing line. A 20 centimeters wide and 20 centimeters long board served as platform is added at each end of the beam (Figure 27).

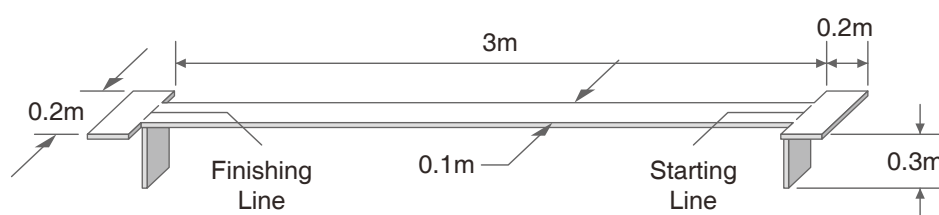

Figure 27 Diagram of the equipment of balance beam

Testing Method: The examinee should stand on the platform before the starting line and face the beam with arms opened. When given the signal to “start”, the examinee should start walking towards the finishing line by alternating both feet (Figure 28). The examiner should stand at the side and front of the examinee to give signals, begin to time once the examinee starts to move and follow the examinee towards the finishing line. At the same time, the examiner should watch the examinee closely to avoid any accidents. When the examinee’s toes cross the finishing line, the examiner should stop timing. The test is done twice. The higher score is recorded using seconds as the measuring unit and rounded to one decimal place. The number at the second decimal place is rounded up if it is not “0”.

Completion format: If the examinee finishes the examination with two feet moving forward alternately, “1” is recorded. If the examinee finishes the examination by moving sideways, “2” is recorded. If the examinee fails to complete the task, “3” is recorded.

Note:

- ① Before testing, the toes of the examinee should not cross the starting line.
- ② The examinee has to conduct the test again if he/she fell while walking.
- ③ The examiner should pay close attention to protect the examinee.



Figure 28 Walking on balance beam

8. Successive Jumps with Both Feet (Young Children)

Apparatus: Measuring tape, stopwatch, ten soft packs (each 10 centimeters long, 5 centimeters wide and 5 centimeters high). A soft pack is placed at 50 centimeters intervals in a straight line on a flat ground, a starting line is drawn at 20 centimeters from the first soft pack (Figure 29).

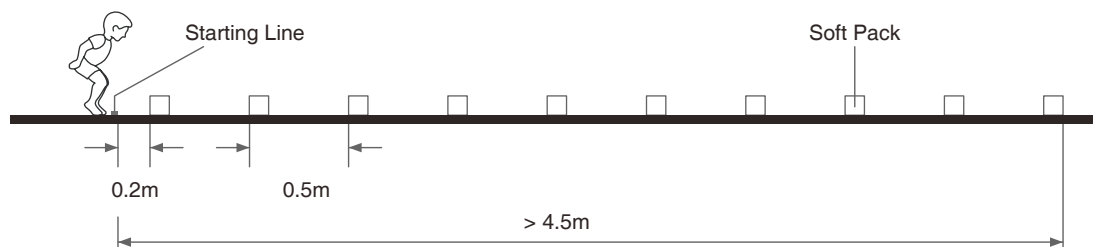

Figure 29 Diagram of the setting of successive jumps with both feet

Testing Method: The examinee should stand behind the starting line with both feet together, upon hearing the “start” signal, start jumping continuously over all 10 soft packs with both feet together (Figure 30). The examiner should begin to time as soon as the examinee starts jumping, and stop timing once the examinee finishes jumping over the tenth soft pack and lands on both feet. The test is done twice. The higher score is recorded using seconds as the measuring unit and rounded to one decimal place. The number at the second decimal places is rounded up if it is not “0”.

Note:

- ① If the examinee walks over the soft packs instead of jumping, jumps on the soft packs, kicks away the packs while jumping or conducts two consecutive hops, the test should be restarted.
- ② If the examinee could not jump over the soft packs with one jump, two jumps are accepted.



Figure 30 Successive jumps with both feet

9. Sit and reach

Apparatus: Electronic sit-and-reach apparatus

Testing Method: The examiner should turn on the apparatus and move the cursor to the near end of the track. When “-20.0 centimeter” or a value less than that is shown on the screen, it means that the apparatus is ready.

Facing the apparatus, the examinee sits on the mat with legs stretched forward, heels together, and feet flat against the apparatus with toes naturally apart. The examiner should adjust the height of the track so that the tips of the examinee’s toes are right below the cursor. During testing, the hands of the examinee should be together, palms face down, knees straight and reach as far as possible pushing the cursor with the middle fingertips (Figure 31). A value would show on the screen. The test is done twice. The higher score is recorded in centimeters and rounded to one decimal place.



Figure 31 Sit and reach

Note:

- ① Before testing, the examinee should conduct warm-up exercise.
- ② During testing, the examinee should not push the cursor with abrupt force, with one hand or bend the knees.
- ③ Before each test, the examiner should move the cursor back to the near end of the track.
- ④ The examiner should record the examinee’s score accurately including the “+” and “-” signs.
- ⑤ If the score of the examinee is less than “-20.0 centimeter”, it should be recorded as “-20.0 centimeter”.

10. Inclined Pull-ups (Males)

Apparatus: One adjustable low horizontal bar or several horizontal bars of different height. The thickness of the bar should be suitable for grasping by the examinees.

Testing Method: The examiner adjusts or selects a horizontal bar that is leveled with the examinee’s chest (nipples). Facing the bar, the examinee should stand relaxed with hands apart at shoulder width, grip the bar with the overhand grip, both legs stretched forward and feet on the ground. Another examiner should anchor the feet of the examinee, ensure the examinee’s arms are perpendicular to the body, and with the body slanting backwards. A complete pull-up composed of bending the arms, pulling the chin to touch or exceed the bar and return to the starting position with straight arms (Figure 32). The examiner should count and record the number of pull-ups the examinee completed.



Figure 32 Inclined pull-ups

Note:

- ① When doing the pull-up, the body should maintain straight without arching the back. If the examinee did a pull-up with the help of moving the feet, arching the back, or the chin fails to reach the bar, that pull-up is not counted as valid.
- ② After the examinee did a pull-up, he must return to the starting position.
- ③ Mats could be placed under the bar and the examiner should stand at the side behind the examinee for protection.

11. Pull-ups (Males)

Apparatus: Several high single bars, the thickness of the bar should be suitable for grasping by the examinees

Testing Method: Facing the single bar, the examinee should stand relaxed, swing the arms backwards, jump and grasp the bar with two hands shoulder width apart using the overhand grip. When the body stops swaying, using the arms at the same time, the examinee should pull the body upwards (no additional movements of the body). One complete pull-up would be when the chin reaches above the bar and the examinee returns to the starting position (Figure 33). The examiner should record the number of pull-ups done by the examinee, using number of times as the measuring unit.

Note:

- ① The examiner could assist if the examinee is relatively short and could not grasp the bar by himself even after jumping.
- ② During testing, the examinee should keep the body straight without bending the knees or arching the back. If the examinee did a pull-up with the help of moving his feet or other additional movements, that pull-up is not counted as valid.
- ③ During testing, there should be safety measures to prevent any accidents.



Figure 33 Pull-ups

12. Vertical Jump

Apparatus: Vertical jump test mat

Testing Method: The examiner turns on the switch and presses the button of the test mat. A flickering signal on the screen and a loud beep means that the mat is ready. The examinee should step on the mat with legs apart and get ready for the jump. The test starts when “0.0” appears on the screen. The examinee should half-squat with bended knees, swing the arms backwards then upwards and jump upwards vertically with full strength (Figure 34). When the examinee lands back on the mat, the value shown on the screen is the result of the test. The test is done twice. The higher score is recorded using centimeters as the measuring unit and rounded to one decimal place.

Note:

- ① When jumping, the examinee should not run and jump, nor bounce multiple times on the spot.
- ② After jumping up and prior to landing, the examinee could not bend the hip or knees.
- ③ If the examinee fails to land back on the mat, the jump would not be counted as valid and the examinee must test again.
- ④ Before each jump, the examiner should wait for the mat to reset to “0” automatically or press the button to reset the value to “0”.



Figure 34 Vertical jump

13. Grip Strength

Apparatus: Grip dynamometer

Testing Method: Before testing, the examinee should grasp the handle of the dynamometer with their stronger hand and adjust the grip length of the dynamometer with the other hand until it is suitable. The examiner should turn on the dynamometer and a flickering signal would appear on the screen. When “0.0” is shown, the dynamometer is ready. During testing, the examinee should stand still with legs shoulder width apart, arms down, palms inward and grip the dynamometer with full strength (Figure 35). The test is done twice. The higher score is recorded using kilograms as the measuring unit and rounded to one decimal place.

Notas:

- ① During testing, the examinee should not swing the arms, bend knees or hold the dynamometer against the body.
- ② If the examinee could not determine which hand is stronger, each hand could be tested twice and the highest score is recorded.
- ③ Before each test, the examiner should press the button to reset the value to “0”.



Figure 35 Grip strength

14. Back Strength

Apparatus: Back dynamometer

Testing Method: Turn on the dynamometer and press the button. A flickering signal would appear on the screen and a “0” means the dynamometer is ready.

The examinee should stand on the back dynamometer with the toes of both feet about 15 centimeters apart, arms down in front of the legs. The examiner would measure the length of the chain by placing the handle in contact with the examinee’s fingertips. The length is measured from the handle to the hook of the dynamometer. During testing, the examinee should grasp the handle with arms straight, legs stretched and head upwards. Then pull with full power using the back (Figure 36). The test is done twice and the higher score is recorded by the examiner using kilograms as the measuring unit, rounded to whole numbers.

Note:

- ① Before testing, the examinee should have done warm-up exercises.
- ② During testing, the elbows and knees should be straight.
- ③ Before each test, the examiner should press the button and reset the value to “0”.



Figure 36 Back strength

15. One-foot Stands with Eyes Closed

Apparatus: Balance monitor

Testing Method: Turn on the switch and press the button of the monitor. A flickering signal on the screen followed by a loud beep means the monitor is ready. The examinee would step on the board, the dominant foot on the pressure sensor in the middle of the board, and the other on the side of the board. A value of “0” would appear on the screen followed by a loud beep. Instruct the examinee to close his/her eyes and raise the foot that is not on the sensor. The loud beep would then stop and the monitor would start counting the time as soon as the other foot is off the board (Figure 37). When the supporting foot of the examinee moves or the raised foot touches the board, a beep would sound signifying the end of the test, and the screen shows the tested value. The test is done twice and the higher score would be recorded by the examiner, rounded to whole numbers.

Note:

- ① Before testing, the examinee should step on the board with both feet. The test would only begin after the examinee stands still.
- ② During the test, the examinee’s eyes should be closed at all times.
- ③ The examiner should pay attention to the examinee for safety precaution.
- ④ Before each test, the examiner should wait for the monitor to go back to “0” automatically or press the button to reset the value to “0”.



Figure 37 One-foot stands with eyes closed

16. Choice Reaction Time

Apparatus: Electronic selective reaction time apparatus

Testing Method: The examiner turns on the apparatus, and when “FYS” appears on the screen, the apparatus is ready. The examinee places the fingers straight together with the middle finger pressed and hold on to the “start” button. When a random “signal” button signals (sound and light illuminated at the same time), use the same hand to press the corresponding “signal” button as fast as possible, then hold on to the “start” button again and wait for the next signal. There would be five signals in total for each test (Figure 38). When all “signal” buttons flash and beep, the test is completed and the choice reaction time would show on the screen. This test is done twice and the small value is recorded and rounded to two decimal places.

Note:

- ① During testing, the examinee should not slam the “signal” buttons.
- ② The examinee should press and hold on to the “start” button until any “signal” button signals. Otherwise, the test could not be continued.
- ③ The “on/off” button should be pressed to begin the next test.



Figure 38 Choice reaction time

17. Push-ups (Males)

Apparatus: Electronic push-up counter

Testing Method: Before testing, the examinee should have both arms stretched at shoulder width apart on the testing board, the trunk maintained straight and legs stretched backward. The examiner adjusts the height of the infrared receiver and reflector to ensure the upper infrared signal is blocked when the examinee is at the starting position, and the lower infrared signal is blocked when the examinee is at the decline position. The examiner should then turn on the switch and a “0” would show on the screen, which means that the counter is ready. At this time, the examiner should press the red button on the testing board. Upon hearing a loud beep, the examinee should bend both arms to lower the body to the same level with the shoulders and elbows. Next, the examinee should push the body up and return to the starting position. This is counted as one push-up (Figure 39). The examinee should repeat the movements continuously. When it takes more than five seconds to complete one push-up or the examiner stays in a position for more than 3 seconds, the apparatus would stop the test automatically. The examiner would record the value displayed on the monitor and the number of push-ups as the measuring unit.

Note:

- ① During testing, if the examinee fails to keep the body straight or lower the body to the same height as the shoulders and elbows, the push-up is not counted as valid.
- ② Press the red button to begin the next test.



Figure 39 Push-ups

18. One-Minute Sit-ups (Females)

Apparatus: Electronic sit-up counter

Testing Method: Before testing, the examinee should put both hands behind the head with fingers crossed, legs spread slightly and lied onto the testing board. The examiner should adjust the knee-supporting frame and feet board so that the examinee could bend the knees at a 90° angle. The height of the infrared receiver and reflector is adjusted to allow the infrared signal be blocked when the examinee is at an upright position. The examiner then turns on the switch and a “0” would show on the screen, which means that the counter is ready. Next, remove the knee-supporting frame and press the red “start” button on the testing board. Upon hearing a loud beep, with arms behind the head, the examinee should tighten the abdominal and sit up, after the elbows touch or exceed the knees, return to the starting position and this is counted as one sit-up (Figure 40). The examinee should do as many sit-ups as possible in one minute. The test is over when the examinee hears a signaling beep. The examiner then records the value displayed using the number of sit-ups as the measuring unit.

Note:

- ① During testing, if the examinee did a sit-up with the help of elbow strength or used hip motions, or if the elbows fail to touch or exceed the knees, that particular sit-up would not be counted as valid.
- ② During testing, the examiner should report to the examinee the number of sit-ups completed.
- ③ Press the red button to begin the next test.



Figure 40 One-minute sit-ups

19. 30-second Chair Stand

Apparatus: A sturdy side chair (about 43cm high), and a stopwatch (stand-by).

Testing Method: The examinee should sit upright on the 43cm high chair (preferably placed against a wall), with feet flat on the ground, arms folded across the chest, back maintained straight and away from the back of the chair. Upon hearing the starting signal, the examinee should rise to a full stand with knees straight, and then return to sit on the chair (Figure 41), this is considered as 1 repetition. The number of repetitions completed within 30 seconds is recorded, using number of times as the measuring unit.

Note:

- ① Before testing, the examinee could warm up by conducting one to two sit-and-stands, check the movements to ensure proper posture and then conduct the test.
- ② The examinee should strictly follow the requirements during the test. It is not counted as valid if the examinee uses the hands as support, fails to sit upright when seated, leans on the back of the chair when seated, or the knees are not straight when standing for that particular repetition.
- ③ After giving the start signal, the examiner should begin timing whether or not the examinee has started the action or not. At the end of the 30 seconds, if the examinee's hip has left the chair, but has not completed a full stand, such repetition is counted into the total score.
- ④ During testing, if the examinee experiences conditions or physical illnesses that make it hard to continue the test such as dizziness, difficulty in breathing or body aches, the examiner should stop the test and handle it properly.
- ⑤ The chair should be placed against the wall when testing for safety.



Figure 41 30-second chair stand

IV. Health Indicators

1. Dental Caries

Apparatus: Flat mouth mirror, #5 probe needle

Testing Method: Examine the teeth one by one in a quadrant order. Any pits, holes and easily decayed areas between the teeth should be thoroughly checked with a probe needle and only then should a diagnosis be made.

Diagnosis Standards:

- ① No tooth decay: no existing fillings and no fillings needed.
- ② Tooth Decay: changes of the color, form and quality of the teeth or between the teeth. Form and quality changes would be the main basis for diagnosis. "Form" change is indicated by destruction of the enamel forming holes. "Quality" change is indicated by softness encountered at the bottom of the hole when picking with the probe needle. If there are white spots or other color spots on the enamel and if there is no softening of a hole when picked with a probe needle, these would not be diagnosed as teeth decay. Decay of primary teeth is marked as "d", and decay of permanent teeth is marked as "D".
- ③ Teeth loss due to decay: Loss of primary teeth not due to normal eruption of the permanent teeth is marked by "m". Permanent teeth taken out due to decay are marked by "M". During diagnosis, the examiner should pay attention to loss of teeth not due to decay but to physiological replacement.

- ④ Filled teeth: For existing filled teeth with no additional primary caries or secondary caries, primary filled teeth were marked by “f”, permanent filled teeth were marked by “F”.
- ⑤ Existing filled teeth with additional primary caries or with secondary caries are regarded as decayed teeth.
- ⑥ Recording method: The teeth quadrant chart is filled after diagnosis by recording d, D, m, M, f, F in the relevant boxes.

(1) There are 16 boxes in the teeth quadrant chart representing “upper” teeth and “lower” teeth respectively. For decayed teeth, the examiner is required to fill in the respective letter into the respective boxes according to the teeth position and types of decay (i.e. primary teeth, permanent teeth etc).

(2) The box after the code of teeth decay is used for filling the examinee’s total number of different types of teeth decayed. It should be recorded in Arabic numbers.

Note:

- ① Examination must be done by dental professionals.
- ② For filled teeth, attention must be paid to examine whether there are new caries within the surface of other teeth and whether there is continuous decay under the filling.
- ③ One probe needle could only be used for not more than 60 examinees (times).
- ④ After completion of examination with each examinee, all tools and equipment must be thoroughly disinfected with high temperature.

2. Vision

Apparatus: Standard eye chart (Figure 42). The height of eye chart is adjusted to make sure that line 5.0 of the eye chart is leveled with the eyes of most of the examinees. Illuminance of the eye chart is about 500 lux.

Testing Method:

- ① The examinee should stand 5 meters away from the eye chart and cover the left eye using a blinder. The right eye is examined first, then the left eye, both as naked-eye vision.
- ② The examiner could start from the optotypes at row 5.0. If the examinee could not identify correctly, the examiner continues to identify row by row upwards. If the examinee could identify row 5.0 correctly, the examiner continues to identify row by row downwards. The examinee is required to identify the optotypes within 5 seconds. The examinee could not make any mistakes from row 4.0 to row 4.5, could not make more than two mistakes within each row from row 4.6 to row 5.0, and could not make more than three mistakes within each row from row 5.1 to row 5.3. The examinee could not continue the test as soon as he/she makes more mistakes than the above requirements, and the previous row is then used as the examinee’s vision score.
- ③ If the examinee could not identify the first row of the eye chart from 5 meters away, the examinee should stand 2.5 meters or 1 meter away to conduct the test. The recorded vision score should then be subtracted by the calibrated values 0.3 and 0.7 respectively.

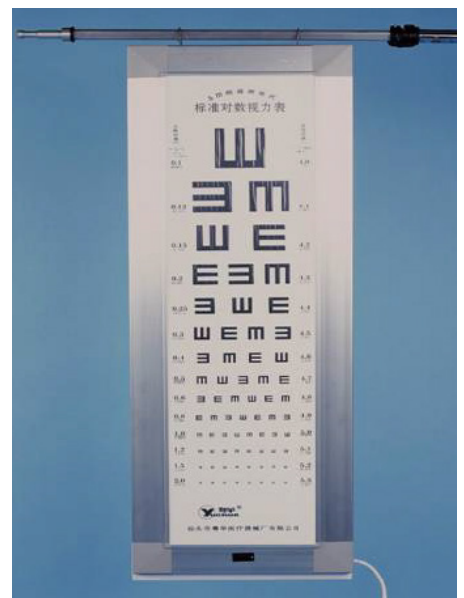

Figure 42 Standard eye chart

For example: If the examinee could not identify the first line of the eye chart from 5 meters away, the examiner could ask the examinee to stand 2.5 meters away. At that distance, the score of the examinee is 4.2, thus the final score of the examinee is $4.2 - 0.3 = 3.9$

For example: If the examinee still could not identify the first line of the eye chart from both 5 meters and 2.5 meters away, the examiner could ask the examinee to stand 1 meter away. At this distance the score of the examinee is 4.2, thus the final score of the examinee is $4.2 - 0.7 = 3.5$.

- ④ If the naked-eye vision of the examinee is above or equal to 5.0, “Normal=0” is recorded into the box behind refractive error, which means the examinee’s vision is within normal range (not belong to refractive error), and further refraction tests are not needed.
- ⑤ If the naked-eye vision is below 5.0, the examinee has poor vision. If the range is above 4.8 to below 5.0, it is considered mild, 4.6 to 4.8 is moderate, and 4.5 or below 4.5 is severe. An array of dioptric lenses are used in the refraction test to determine the presence of refractive error. An examinee is considered as nearsighted when the vision decreases when imposing the plus lenses and increases with minus lenses, vice versa for farsighted. If no improvement is detected after the use of dioptric lenses, it would be indicated as other reasons.
- ⑥ Recording method: Fill the score for both the left and right eyes of the examinee in the relevant boxes.

For example, if the score of the naked-eye vision is 5.0 for the left eye and 4.6 for the right eye, then the

examiner should fill in the left box with

5	0
---	---

, and right box with

4	6
---	---

.

- ⑦ Recording method of calibrated refraction test and refractive errors: ↓ represents decreased vision, ↑ represents improved vision and “0” represents no changes in vision. Put the calibrated result on respective lines for left and right eyes, and the respective codes of refractive errors into the left and right boxes. The code “0” represents normal, “1” represents nearsighted, “2” represents farsighted, and “3” represents others.

For example, poor vision is detected in an examinee. After the refraction test, vision of both the left and right eyes has decreased with positive lenses while vision has improved with negative lenses. The examiner should mark ↓ on the line for positive lenses and ↑ on the line for negative lenses for both the left and right lines of calibrated results. Since the left and right eyes are assessed as “nearsighted”, so “1” is put into the box for the left and right refractive errors results.

For example, poor vision is detected in an examinee. After the refraction test, vision of the left eye has improved using positive lenses while vision has decreased with negative lenses, the left eye is then diagnosed as “farsighted”. No change in the right eye’s vision is detected using both the positive and negative lenses, “others” would be stated. Therefore, ↑ is put on the line of positive lenses and ↓ on that of the negative lenses for the calibrated results. On the right line, “0” is marked for both positive and negative lenses. “2” (farsighted) and “3” (others) are put on the left and right boxes respectively of the refractive errors part.

Note:

- ① Before vision examination, the examiner should explain the purpose, significance, and methods of the examination to the examinee to obtain cooperation, and to remove wearing glasses to examine their naked-eye vision.
- ② If natural light is used for the examination, the examiner should choose a sunny day, a fixed time and location for comparison before and after.
- ③ Before examination, the examinee should not rub the eyes. During examination, the examinee should not squint the eyes or look sideways. The examiner should be monitoring at all times.

- ④ When using the eye blinder, the examinee should be reminded not to press onto the eye ball to prevent affecting the vision.
- ⑤ The examination team would assign professionals to check vision.
- ⑥ It was not proper to have the vision checked after working under pressure or using the eyes, strenuous exercise or heavy physical labour. At least 10 minutes rest is needed before the examination. If the examination is carried out indoor, the examinee should allow 10 minutes to adapt to the environment after entering the room.

3. Color Vision Deficiency Examination

Apparatus: Color Vision Examination Chart Second Edition (People Health Publishing House, edited by Wang Kechang, 2004) (Figure 43).

Testing Method: The chart should be displayed under bright natural light (Sunlight should not shine directly onto the pictures) or under fluorescent light. The examinee should be seated with 40 to 80 centimeters distance between the eyes and the pictures. The examiner should use the first picture (example picture) to instruct the examinee the correct way to do the examination, then the examiner would pick 3 pictures at random from picture 2 to picture 8 for the examination (Figure 44). If the examinee passes the examination, the color vision of the examinee is normal; otherwise, it is abnormal. The examiner should also record “normal” or “abnormal” accordingly. The code is 1 for “normal” and 2 for “abnormal”.

Note:

- ① Sunlight should not shine directly on the face of the examinee.
- ② After each examination, the examiner should close the chart immediately
- ③ When reading the pictures, avoid saliva from falling onto the pictures.
- ④ Both the examiner and the examinee should not touch the picture with their hands to prevent damage to the pictures. If necessary, a small stick can be used for pointing.
- ⑤ Do not examine the color vision after using the eyes for long hours, strenuous exercise and heavy physical labour. At least 10 minutes of rest is needed before examination. The examinee should also have 10 minutes to adapt to the environment after entering the room from outdoors.
- ⑥ Before examination, the examinee should not rub the eyes. During examination, the examinee should not squint the eyes or look sideways. The examiner should be monitoring at all times.



Figure 43 Color Vision Examination Chart



Figure 44 Color Vision Deficiency Examination

Appendix 4: Sampling Sites of 2020 Physical Fitness Study of Macao SAR Residents

Subjects	Kindergarten code number	Name of kindergarten	Parish of main campus
Young children (aged 3~6)	4001	Keang Peng School (primary school section – kindergarten)	Nossa Senhora de Fátima (Northern area)
	4002	Hou Kong Middle School Affiliated Kindergarten	
		Hou Kong Middle School Affiliated Primary School (kindergarten)	
	4003	Pui Ching Middle School (kindergarten)	Santo António and São Lázaro (Central area)
	4004	Chan Sui Ki Perpetual Help College (subsidiary school)	
	4005	Pooi To Middle School (branch school of Praia Grande – kindergarten)	Sé Catedral and São Lourenço (Southern area)
		Pooi To Middle School (Taipa branch school – kindergarten)	
4006	Estrela do Mar School (kindergarten)		

Subjects	School /university code number	Name of school / university	Parish of main campus
Children and Adolescents (Students aged 6~22)	4021	Keang Peng School (primary school section)	Nossa Senhora de Fátima (Northern area)
		Keang Peng School (secondary school section)	
	4022	Hou Kong Middle School Affiliated Primary School	
		Hou Kong Middle School	
	4023	Pui Ching Middle School	Santo António and São Lázaro (Central area)
	4221	Colegio Dom Bosco (Yuet Wah) Chinese Section	
	4222	Yuet Wah College (Chinese Section)	
	4223	Sacred Heart Canossian College	
	4025	Pooi To Middle School (branch school of Praia Grande)	Sé Catedral and São Lourenço (Southern area)
		Pooi To Middle School (primary school section)	
		Pooi To Middle School (Taipa Primary Branch)	
		Pooi To Middle School	
	4026	Estrela do Mar School	
		Estrela do Mar School (branch school)	
	4027	University of Macau	--
	4028	Macao University of Science and Technology	
4029	Macao Polytechnic Institute (Currently known as Macao Polytechnic University)		
4030	Kiang Wu Nursing College of Macao		
4031	Institute for Tourism Studies		
4121	Others		

Subjects	Work unit code number	Name of work unit
Adults (aged 20~59)	4041	Health Bureau
	4042	Education and Youth Affairs Bureau (currently known as Education and Youth Development Bureau)
	4043	Macao Government Tourist Office
	4044	Statistics and Census Service
	4045	Macao Sports Bureau
	4046	Municipal Affairs Bureau
	4048	Marine and Water Bureau
	4049	Social Welfare Bureau
	4050	Land, Public Works and Transport Bureau
	4056	Labour Affairs Bureau
	4057	CEM-Companhia de Electricidade de Macau
	4059	Macao Polytechnic Institute (currently known as Macao Polytechnic University)
	4060	The Women's Association of Macau
	4061	Macao New Chinese Youth Association
	4062	Galaxy Entertainment Group
	4064	Others (individual)
	4065	Sands China Ltd.
	4067	Christian Sheun Tao Church Hong Kong & Macau District Union Association
	4068	União Geral das Associações dos Moradores de Macau
	4070	Macao Federation of Trade Unions
	4141	Melco PBL Gaming (Macao)
	4142	Bank of China Macau Branch
	4144	Macao Red Cross
	4145	University of Macau
	4241	Sheraton Grand Macao
	4242	SJM Holdings Limited
	4244	Institute for Tourism Studies
	4245	Macao University of Science and Technology
	4341	Wynn Resorts (Macao)
	4342	Macao Fisherman's Wharf
4343	Transport Bureau	

Subjects	Senior agency code number	Name of senior agencies	Parish
Seniors (aged 60~79)	4172	Community Organizations of União Geral das Associações dos Moradores de Macau (General Union of Neighbourhood Associations of Macau)	Nossa Senhora de Fátima (Northern area)
	4271	Centro de Convívio da Associação de Mútuo Auxílio dos Moradores de Mong-Há	
	4274	Centro de Convívio da Obra das Mães	
	4275	Centro de Actividades para Idosos de “Tung Sin Tong” (Macao Tung Sin Tong Charitable Society Senior Activity Center)	
	4282	Service Centers of Federação das Associações dos Operários de Macau (Macao Federation of Trade Unions)	
	4371	Centro das Idosas da Associação Geral das Mulheres de Macau	Santo António and São Lázaro (Central area)
	4372	Centro de Dia “Chong Pak Chi Ká”	
	4082	Centro de Convívio da Associação dos Habitantes das Ilhas Kuan Iek	Sé Catedral, São Lourenço and Nossa Senhora do Carmo (Southern and islands area)
	4177	Macao Polytechnic Institute – Seniors Academy (Currently known as Macao Polytechnic Institute – Seniors Academy)	
	4178	Service Centers of Associação Geral das Mulheres de Macau (The Women’s Association of Macau)	
	4373	Casa dos “Pinheiros” da Taipa	
	4374	Centro Diurno Prazer para Idosos da Associação Geral das Mulheres de Macau	
	4180	Others (individuals aged 60 onwards working in the sampling sites of adults)	--

Acknowledgement

The successful completion of “2020 Physical Fitness Report of Macao SAR Residents” is the result of the joint efforts from different institutes. We, the Sports Bureau of Macao SAR Government, would like to sincerely thank the China Institute of Sport Science of the General Administration of Sport of China for their technical support. We would also like to thank the coordinating institutes, including the Education and Youth Development Bureau, the Health Bureau, the Social Welfare Bureau, and Macao Polytechnic University for their great support and coordination. In addition, we would like to express our deepest gratitude to all the schools, public and private organizations, community groups and senior agencies involved for their active participation and support. We would also like to thank all the subjects who participated in the study.



澳門特別行政區政府體育局
Instituto do Desporto do Governo da RAEM

www.sport.gov.mo

ISBN 978-99981-897-3-7



9 789998 189737